

EX-6 series

HITACHI

EX

26000



HYDRAULIC EXCAVATOR

- **Model Code** : EX2600-6
- **Engine Gross Power** : 1 119 kW (1 500 HP)
- **Operating Weight** : Loading Shovel : 252 000 kg
Backhoe : 254 000 kg
- **Loading Shovel Bucket** : Heaped : 15.0 m³
16.5 m³
- **Backhoe Bucket** : SAE, PCSA Heaped : 17.0 m³
CECE Heaped : 15.0 m³

Tremendous Production with the Gigantic Excavators from Hitachi.

The Hitachi Giants Keep on Progressing.
The Buckets Get Bigger... Along with Enhanced Reliability and Durability.
Massive Production and Power on Hand.



Engine Gross Power : 1 044 kW (1 400 HP) **▶ 1 119 kW (1 500 HP)**
EX2500-6

Bucket Capacity : Backhoe : 15.0 m³ **▶ 17.0 m³**
EX2500-6

Note: Photos in this brochure may include optional equipment.
They may also include custom-made options to meet specific user needs.

SOLUTION GIANT

Giant-Sized Productivity Based on Hitachi's Theory of Evolution.

Each Hitachi generation listens to the needs of the work site and gives birth to an even-better new generation.



Bucket Passes to Dump Trucks

	HITACHI EH1700-3	140 tonnes class	HITACHI EH3500ACII
Nominal Payload	95.2 tonnes	140 tonnes	168 tonnes
Backhoe 17.0 m ³	3 or 4	5	6
Loading Shovel 15.0 m ³	3 or 4	5 or 6	6 or 7

17.0 m³ backhoe bucket is best matched with 140 tonnes class dump trucks.



Powerful Single Engine— Ready for the task.

Time-proven Cummins diesel engine produces a total of 1 119 kW (1 500 HP) for handling the big excavation jobs.

- 1 119 kW (1 500 HP)

Emission Control Engine— Helping to protect our environment.

Conforms to U.S. EPA Tier II emission regulations.

Efficient E-P Control— Adjusts power output to the work being performed.

Hitachi's computer-aided Engine-Pump Control (E-P Control) coaxes optimum efficiency from the engine and hydraulic pumps. This innovative system senses load demand and controls engine and pump output for maximum operating efficiency.

Larger Bucket Provides High Work Capacity.

- Backhoe bucket : 17.0 m³
- Loading shovel bucket : 15.0 m³

Maximum Excavating Force.

- Backhoe : Arm crowd force (ISO) : 785 kN (80 000 kgf)
(SAE : PCSA) : 765 kN (78 000 kgf)
Bucket digging force (ISO) : 830 kN (84 600 kgf)
(SAE : PCSA) : 760 kN (77 500 kgf)
- Loading shovel : Arm crowding force : 918 kN (93 600 kgf)
Breakout force : 943 kN (96 200 kgf)

Large Bucket— Designed to enhance efficiency.

The large bucket has been shaped specifically to enhance scooping and loading operations. Its sharp tilt angle helps boost operating efficiency.

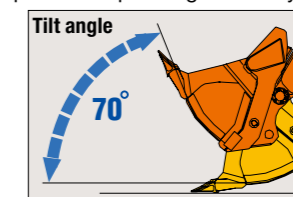

Productivity-Boosting Auto-Leveling Mechanism— One-lever leveling control.

This is another unique Hitachi function developed exclusively for more efficient leveling operations.

SOLUTION GIANT

More Than Durable — Just Plain Tough

Built-in toughness means the Hitachi will continue to get giant-sized jobs done fast.



Rigid Box Design— Resists bending and twisting forces.

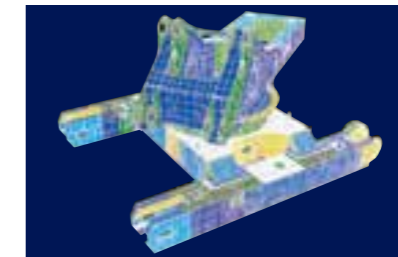

Computer-assisted analysis was used to check that the frame box can withstand heavy-duty excavation work.

Center Track Frame



The center track frame of integral cast steel structure can avoid stress concentration, and increase reliability.

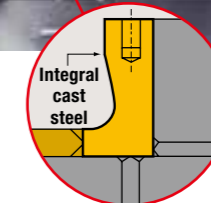

Strategically Positioned Oil Cooler— Helps keep oil temperatures



The oil cooler is used for optimal cooling efficiency. It is positioned far from the engine radiator for even better cooling potential.

High-Mounted Compact Travel Motors and Optional Travel Motor Guard— Help to boost durability at rugged work sites.



This design helps protect the travel motors from damage by rocks.

Rugged Track Links— Shoes include roller guides for extended service life.

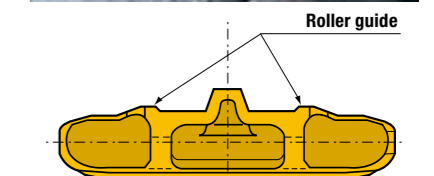

This design has proven itself on Hitachi's popular Giant EX Series. The roller guides have been added to help extend service life.

Constant Correct Track Tension— Nitrogen gas accumulators absorb abnormal track tension.

Helps prevent abnormal track tension from causing damage. Travel is automatically stopped if accumulator pressure exceeds a preset level.



SOLUTION GIANT

Designed to Offer Comfort and Intelligence

Comfortable operator space and simplified maintenance, backed by Hitachi technologies and experience.

High Visibility 6.4 Meter Cab Height— Providing a clear view of the work area.

Gives the operator a clear view, even when a large 190 tonnes class dump truck is being loaded. This high height and forward-sloping cab provides a view that boosts productivity.

Rugged Comfortable Cab— Protects the operator from falling objects.

Fluid filled elastic mounts help absorb vibration to provide durability and a comfortable ride. The OPG* top guard level II (ISO) is provided on the cab roof.

*Operator Protective Guard

Efficient Cab Layout— All controls within natural reach of operator.

The ergonomic layout of the cab means the operator will do less stretching and reaching when operating the controls. This adds up to less operator fatigue and greater operating efficiency.

Electric Joystick Levers— Provides pleasant control with less fatigue.

Electric joystick control levers have a feather-touch allowing long periods of effortless operation. Its stroke is much shorter than that of hydraulic control.

Air Suspension Seat with Auto Operator Weight Adjuster.

The operator seat cushion can automatically be adjusted according to the operator weight. This is convenient for a machine operated by two or more operators.

Adjustable Sliding Cockpit— Moves to the best position for the operator.

The operator can adjust the position of the levers and the seat to custom fit his size and operating style.

Constant-Cab-Comfort Air Conditioner— Keeps the cab pressurized to keep out dust while maintaining comfortable temperature.

Intelligent Multi-Display Monitor provides machine data and operating status at a glance.

The operator can monitor machine conditions and operating status with a 10.5-inch color LCD. The controller provides instant fault diagnosis through all sensors, displaying warnings and countermeasures if failure arises.

Major Functions:

- Multiple meters, and alert symbols indication
- Alert/failure status, and countermeasures indication
- Snap-shot function that stores operating data, including five-minute operating data immediately before alerting, and succeeding one-minute data (temperatures, pressures, and more)
- Setting oil change intervals with alerting



* Illustration shows a sample of the Emergency Switch.

Much more functions are provided to ease maintenance and servicing.

Outside Cameras (Optional)— Enhances operating safety.

The operator can monitor around the machine, using four optional cameras to eliminate blind spots.

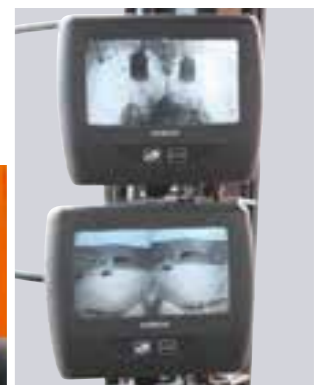

SOLUTION GIANT

Designed to be Maintenable

Carefully engineered to allow full 24-hour operation.

Easy Access and Maintenance— Easy access speeds inspections and maintenance.

- | | |
|-----------------------------------|----------------------------------|
| 1 Diesel Engine | 14 Hydraulic Tank |
| 2 Pump Drive Unit | 15 Fuel Tank |
| 3 Hydraulic Pump x 6 | 16 Battery Unit |
| 4 Hydraulic Oil Cooling Fan Motor | 17 Lubricator |
| 5 Hydraulic Oil Cooler | 18 High Pressure Strainer x 6 |
| 6 Engine Radiator | 19 Reserve Tank (Engin Oil) |
| 7 LTA Radiator | 20 Reserve Tank (Coolant) |
| 8 Fuel Cooler | 21 Air Filter x 2 (Outer/Inner) |
| 9 Pump Transmission Oil Cooler | 22 Muffler |
| 10 Engine-Pump Bulkhead | 23 Fuel Filter (Water Separator) |
| 11 Control Valve x 3 | 24 Cab |
| 12 Swing Device x 2 | 25 Ladder |
| 13 Center Joint | 26 Folding Stairs |
| | 27 Ladder |

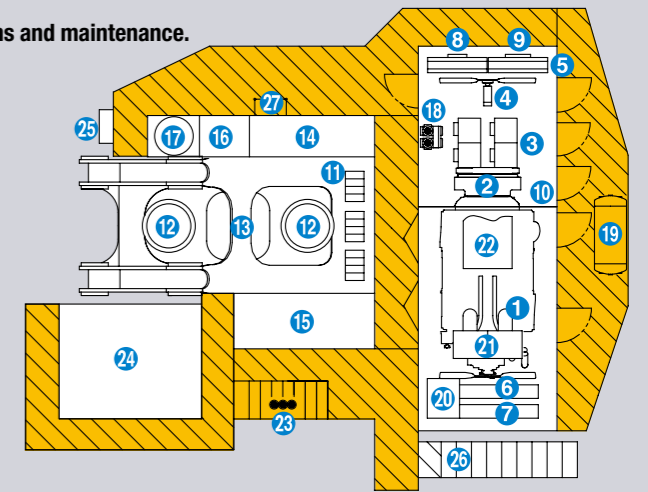

Counterweight with Walkway— Easier access for maintenance.



A walkway around the entire counterweight provides easy access to key rear areas. This means faster and safer inspection and maintenance.

Folding Stairs with Wide Steps.



Folding stairs is designed for easy access to the machine for servicing and maintenance.

Wide-Open Service Area— Provides the space needed for quick and easy inspection and maintenance.



This area is conveniently located at the center of the body and provides access to the engine as well as the hydraulic and electrical systems.

Auto Lubrication System Eliminates the need for manual lubrication.

This system automatically lubricates the front joint pins and swing circle. This eliminates cumbersome daily lubrication.

Easy-to-Replace Grease Drum Can— Designed to provide quick and easy grease drum can changes.

The compartment floor slides down to lower a drum for simple, easy replacement.



Convenient Centralized Filter System— Designed to make filter inspection and maintenance easier.

Centralized position means that inspection and maintenance can be performed quickly and easily.



The Centralized Lubrication System: Fast Filling System



Low Maintenance Dust Ejector— Automatically expels dust from the air cleaner.

This is one less time-consuming task during routine maintenance.

Contamination sensor— Alerts the operator of excessive contaminants in the oil.

This system detects accumulated contaminants that could cause damage and alerts the operator before trouble occurs.



MIC Mining

The MIC Mining comprises the DLU (Data-logging unit) on the machine DLU continuously records performance of the engine and the hydraulic system. The record can be download by PC and PDA*.

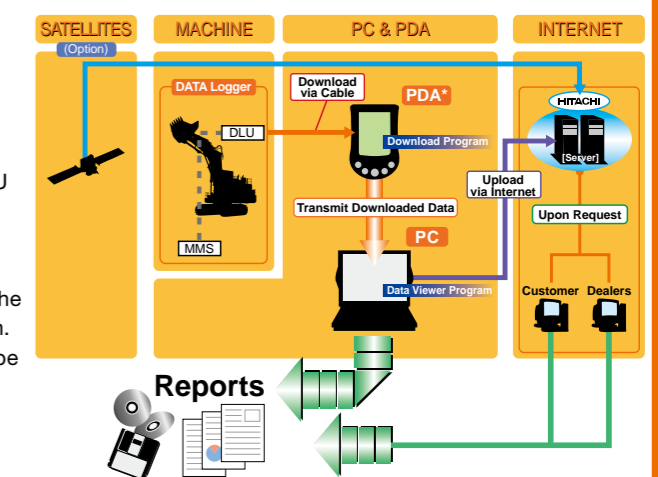

* Personal Digital Assistant

SPECIFICATIONS

WORKING RANGES

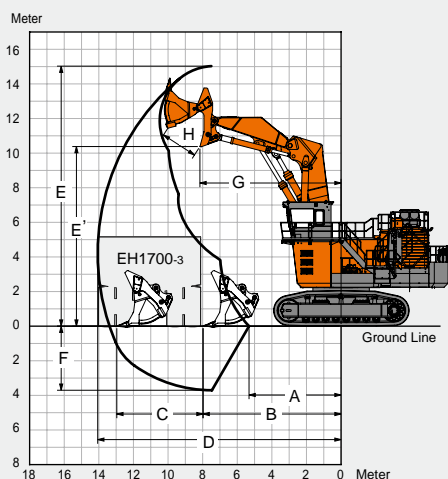

Loading Shovel

Bucket capacity 15.0 m³ / 16.5m³
 A Min. digging distance
 5 340 mm / 5 200 mm
 B Min. level crowding distance
 7 980 mm / 8 240 mm
 C Level crowding distance
 4 980 mm / 4 960 mm
 D Max. digging reach
 14 060 mm / 14 300 mm
 E Max. cutting height
 15 010 mm / 15 250 mm
 E' Max. dumping height
 10 350 mm / 10 350 mm
 F Max. digging depth
 3 720 mm / 3 960 mm
 G Working radius at max.
 dumping height
 8 140 mm / 8 140 mm
 H Max. digging opening width
 2 150 mm / 2 150 mm
 Arm crowding force on ground
 918 kN (93 600 kgf) /
 907 kN (92 500 kgf)
 Bucket digging force
 943 kN (96 200 kgf) /
 873 kN (89 000 kgf)

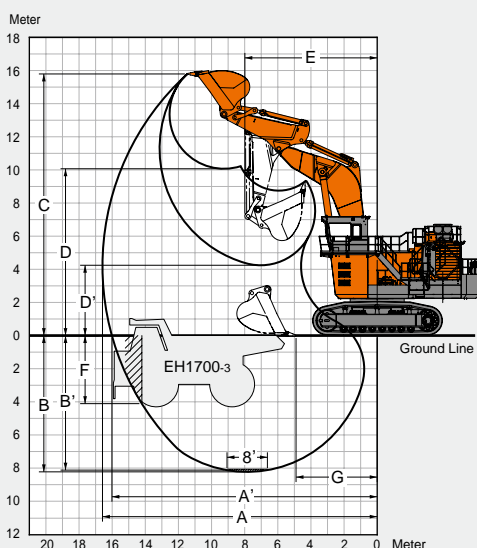

Backhoe

BE-boom length 8.7 m
 BE-arm length 3.9 m
 Bucket capacity 17.0 m³
 A Max. digging reach
 16 600 mm
 A' Max. digging reach (on ground)
 16 050 mm
 B Max. digging depth 8 250 mm
 B' Max. digging depth (8' level)
 8 150 mm
 C Max. cutting height
 15 800 mm
 D Max. dumping height
 10 100 mm
 D' Min. dumping height
 4 250 mm
 E Min. swing radius
 7 990 mm
 F Max. vertical wall
 4 110 mm
 G Min. level crowding distance
 4 900 mm
 Bucket digging force
 ISO 830 kN (84 600 kgf)
 SAE: PCSA 760 kN (77 500 kgf)
 Arm crowd force
 ISO 785 kN (80 000 kgf)
 SAE: PCSA 765 kN (78 000 kgf)

DIMENSIONS

Unit: mm

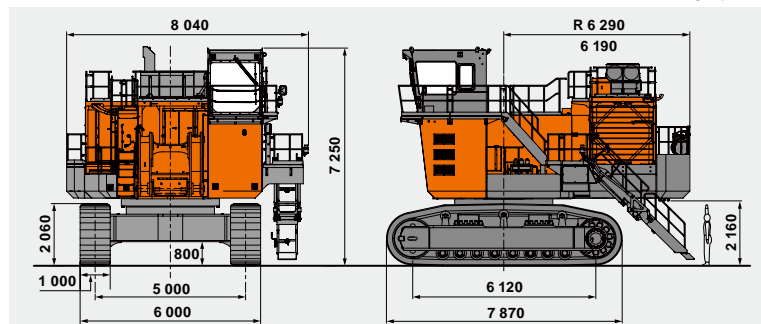

ENGINE

Model..... Cummins QSKTA50-CE
 Emission Certification .. U.S. EPA Tier 2
 Rated power
 SAE J1995, gross ... 1 119 kW (1 500 HP) at 1 800 min⁻¹ (rpm)
 Net..... 1 069 kW (1 434 HP) at 1 800 min⁻¹ (rpm)
 Piston displacement.... 50.0 L
 Fuel tank capacity 5 300 L

HYDRAULIC SYSTEM

Main pumps..... 6 variable-displacement, axis piston pumps for front attachment, travel and swing
 Pressure setting 29.4 MPa (300 kgf/cm²)
 Max. oil flow 4 X 375 L/min, 2 X 425 L/min

UPPERSTRUCTURE

Swing speed 3.8 min⁻¹ (rpm)

UNDERCARRIAGE

Travel speeds..... High: 0 to 2.3 km/h
 Low : 0 to 1.6 km/h
 Maximum traction force... 1 330 kN (135 600 kgf)
 Grade ability 58 % (30 degree) max.

WEIGHTS AND GROUND PRESSURE

Loading Shovel

Equipped with 15.0 m³ (heaped) bottom dump bucket

Shoe width	Operating weight	Ground pressure
1 000 mm	252 000 kg	183 kPa (1.87 kgf/cm ²)

Backhoe

Equipped with 8.7 m boom, 3.9 m arm, and 17.0 m³ (SAE, PCSA heaped) bucket

Shoe width	Operating weight	Ground pressure
1 000 mm	254 000 kg	185 kPa (1.89 kgf/cm ²)

ATTACHMENTS

Loading Shovel

Bucket Capacity (heaped)

15.0 m³ : Materials density 1 800 kg/m³

16.5 m³ : Materials density 1 600 kg/m³

Backhoe

Bucket Capacity (SAE, PCSA heaped)

17.0 m³ : Materials density 1 800 kg/m³

The number of wear plates and their installation positions on the bucket of loading shovel or backhoe vary depending on applications at job site. The installation of wear plates is indispensable.

Consult your nearest Hitachi or Hitachi dealer for details.

These specifications are subject to change without notice.

Illustrations and photos show the standard models, and may or may not include optional equipment, accessories, and all standard equipment with some differences in color and features.

Before use, read and understand the Operator's Manual for proper operation.