

# clarion®

**Owner's manual & Installation manual**

**Pedoman Pemilik & Pemasangan**

**사용설명서 및 설치설명서**

**使用说明书 & 安装手册**

**คู่มือใช้งานและคู่มือการติดตั้ง**

## CZ302A

**Bluetooth® CD/USB/MP3/WMA RECEIVER**

**PENERIMA Bluetooth® CD/USB/MP3/WMA**

**Bluetooth® CD/USB/MP3/WMA 수신기**

**Bluetooth® CD/USB/MP3/WMA接收机**

**เครื่องรับสัญญาณBluetooth® CD/USB/MP3/WMA**

## Contents

Thank you for purchasing this **Clarion** product.

- Please fully read this owner's manual before operating this equipment.

<b>1. FEATURES</b> .....	<b>2</b>
Expanding Systems .....	2
<b>2. PRECAUTIONS</b> .....	<b>3</b>
Front Panel / Generalities .....	3
Remove the DCP .....	3
Attach the DCP .....	3
<b>3. CONTROLS</b> .....	<b>4</b>
Operational Panel .....	4
Names of Buttons .....	4
Remote Control (RCX001: Sold by separately) .....	4
Notes of remote control using .....	4
<b>4. CAUTIONS ON HANDLING</b> .....	<b>5</b>
Handling Discs .....	5
<b>5. OPERATIONS</b> .....	<b>5</b>
Basic Operations .....	5
System Setup .....	6
Audio Setup .....	6
Radio Operations .....	7
CD/MP3/WMA Operations .....	7
USB Operations .....	8
iPod & iPhone Operations .....	8
Bluetooth Operations .....	9
AUX Operations .....	10
<b>6. TROUBLE SHOOTING</b> .....	<b>10</b>
<b>7. ERROR DISPLAYS</b> .....	<b>11</b>
<b>8. SPECIFICATIONS</b> .....	<b>11</b>
<b>9. INSTALLATION / WIRE CONNECTION GUIDE</b> .....	<b>12</b>

## 1. FEATURES

- **Built-in Parrot Bluetooth® Handsfree (HFP) and Audio Streaming (A2DP & AVRCP)**
- **Compatible with iPod® / iPhone® via USB**
- **4ch RCA Output with HPF/LPF and BEAT-EQ with 3 Band Parametric Equalizer**



### Expanding Systems

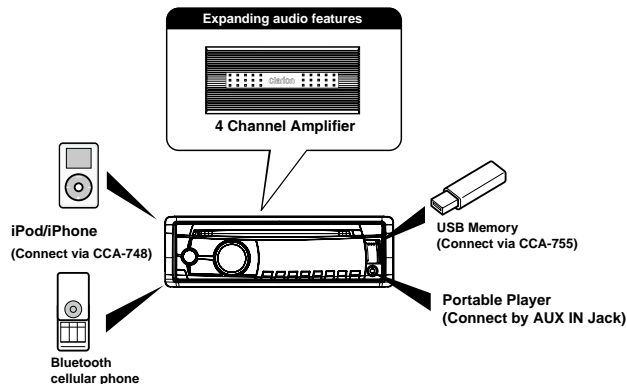

**Note:**

- The items listed outside of the frames are the commercial products generally sold.
- CCA-748 and CCA-755: Sold by separately.

## 2. PRECAUTIONS

### ⚠ WARNING

For your safety, the driver should not operate the controls while driving. Also, while driving, keep the volume to a level at which external sounds can be heard.

- When the interior of the car is extremely cold and the player is used soon after switching on the heater, moisture may form on the disc or the optical parts of the player and proper playback may not be possible. If moisture forms on the disc, wipe it off with a soft cloth. If moisture forms on the optical parts of the player, do not use the player for about one hour. The condensation will disappear naturally allowing normal operation.
- Driving on extremely bumpy or rough roads can cause the disc to skip during playback.
- This unit uses precision parts and components for its operation. In the event that trouble arises, never open the case, disassemble the unit, or lubricate the rotating parts. Contact your Clarion dealer or service center.
- "Made for iPod," and "Made for iPhone" mean that an electronic accessory has been designed to connect specifically to iPod, or iPhone, respectively, and has been certified by the developer to meet Apple performance standards. Apple is not responsible for the operation of this device or its compliance with safety and regulatory standards. Please note that the use of this accessory with iPod or iPhone may affect wireless performance. iPhone and iPod are trademarks of Apple Inc., registered in the U.S. and other countries.
- The Bluetooth word mark and logos are owned by the Bluetooth SIG, Inc. and any use of such marks by Clarion Co., Ltd. is under license. Other trademarks and trade names are those of their respective owners.

### Front Panel / Generalities

For a longer service life, be sure to read the following cautions.

- Do not allow any liquids on the unit from drinks, umbrellas, etc. Doing so may damage the internal circuitry.
- Do not disassemble or modify the unit in any way. Doing so may result in damage.
- Do not let cigarettes burn the display. Doing so may damage or deform the body.
- If a problem should occur, have the unit inspected at your store of purchase.
- The remote control unit may not work if the remote control sensor is exposed to direct sunlight.

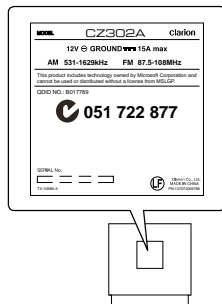

### Cleaning the body

- Use a soft, dry cloth and gently wipe off any dirt or dust.
- For tough dirt, apply some neutral detergent diluted in water to a soft cloth, wipe off the dirt gently, then wipe again with a dry cloth.
- Do not use benzene, thinner, car cleaner, etc., as these substances may damage the body or cause the paint to peel. Also, leaving rubber or plastic products in contact with the body for long periods of time may cause stains.

### Remove the DCP

The control panel can be detached to prevent theft. When detaching the control panel, keep it in the safety place and prevent scratches.

We recommend taking the DCP (DETACHABLE CONTROL PANEL) with you when leaving the car.

- Press the [SRC / ⏏] button (1 sec.) to turn off the power.
- Deeply push in [OPEN] button to unlock the DCP.
- Hold the side popped out, remove the DCP.

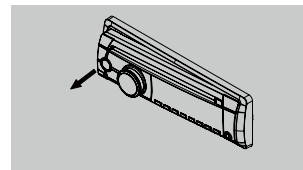

### Attach the DCP

- Hold the DCP and ensure that the panel faces towards you. Set the right side of the DCP into the DCP bracket.
- Press the left side of the DCP until it locks.

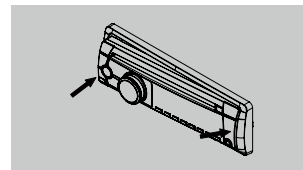

### ⚠ CAUTION

- The DCP can easily be damaged by shocks. After removing it, be carefully not to drop it or subject it to strong shocks.
- Once the [OPEN] button is pressed and DCP is unlocked, car vibrations can cause the DCP to fall.
- The connector for the main unit and DCP is extremely important. Be careful not to damage it by pressing on it with fingernails, screwdrivers, etc.

### Note:

If the DCP is dirty, wipe off the dirt with a soft, dry cloth only.

## 3. CONTROLS

### Operational Panel

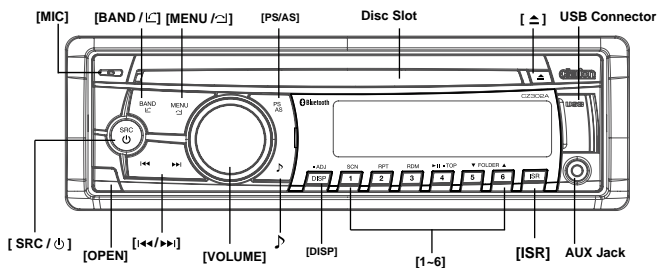

### Names of Buttons

#### [SRC / $\phi$ ] Button

- Power / Toggle the audio source

#### [BAND / $\square$ ] Button

- **RADIO** mode – Select tuner band
- **BT** mode – Dial / Answer / Transfer call / Redial(long press)

#### [MENU / $\square$ ] Button

- **MP3/WMA** mode – Search function.
- **CD** mode – No function.
- **RADIO** mode – No function.
- **AUX** mode – No function.
- **USB** mode – Search function
- **iPod** mode – iPod menu
- **BT** mode – Terminate call

#### [ $\triangle$ ] Button

- Press to eject disc.

#### [ $\ll$ , $\gg$ ] Buttons

- Previous / next track
- Search (long press)

#### [Open] Button

- Unlock the front panel.

#### [PS / AS] Button

- Scan play / Preset scan
- Auto memory store (long press)

#### [ $\triangleright$ ] Button

- Sound effect setting

#### [VOLUME] Knob

- Adjust volume level / Confirm (press)

#### [ISR] Button

- Recall ISR station stored in memory and store current station in ISR memory (long press)

#### [1-6] Buttons

- [1] Button: Scan play / Preset station 1.
- [2] Button: Repeat play / Preset station 2.
- [3] Button: Random play / Preset station 3.
- [4] Button: Play / Pause / Top play (long press) / Preset station 4.
- [5] Button: Previous folder / Preset station 5. 10 tracks down (long press)
- [6] Button: Next folder / Preset station 6. 10 tracks up (long press)

#### [DISP] Button

- Display switch
- System setup (long press)

#### [MIC] Hole

- Internal microphone

### Remote Control (RCX001: Sold by separately)

#### [SRC / $\phi$ ] Button

- Toggle the audio source
- Power on / Power off (long press)

#### [ $\ll$ , $\gg$ ] Buttons

- Preset station up/down
- Previous/next track
- Search(long press)

#### [SCN/PS/AS] Button

- Scan play / Preset scan
- Auto memory store (long press)

#### [BAND/TOP] Button

- Select tuner band (RADIO mode)
- Top play (long press)

#### [ $\triangle$ , $\nabla$ ] Buttons

- Volume up / down

#### [ $\parallel$ ] Button

- Play / Pause

#### [ISR] Button

- Recall ISR station stored in memory and store current station in ISR memory (long press)

#### [DISP] Button

- Display switch

#### [RDM] Button

- Random play

#### [RPT] Button

- Repeat play

#### [MUTE] Button

- Mute the volume

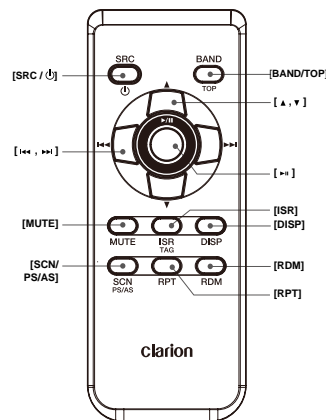

### Notes of remote control using

1. Aim the remote control at the remote sensor on the unit.
2. Remove the battery from the remote control or insert a battery insulator if the battery has not been used for a month or longer.
3. DO NOT store the remote control under direct sunlight or in high temperature environment, or it may not function properly.
4. Use "button shaped" lithium battery "CR2025" (3V) only.
5. DO NOT subject battery to recharge, disassemble, heat or dispose in fire or water.
6. Insert the battery in proper direction according to the (+) and (-) polarities.
7. Store the battery in a place where children cannot reach to avoid the risk of accident.

### Inserting the Battery

1. Slide remote control unit's rear cover in the direction shown.
2. Insert battery (CR2025) into insertion guides with printed side (+) up.
3. Press battery into compartment as shown.
4. Replace and slide cover until it clicks into place.



## 4. CAUTIONS ON HANDLING

### Handling Discs

#### Handling

- New discs may have some roughness around the edges. If such discs are used, the player may not work or the sound may skip. Use a ball-point pen or the like to remove any roughness from the edge of the disc.

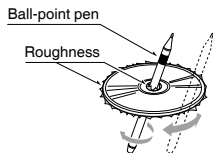

- Never stick labels on the surface of the disc or mark the surface with a pencil or pen.
- Never play a disc with any cellophane tape or other glue on it or with peeling off marks. If you try to play such a disc, you may not be able to get it back out of the player or it may damage the player.
- Do not use discs that have large scratches, are misshapen, cracked, etc. Use of such discs may cause misoperation or damage.
- To remove a disc from its storage case, press down on the center of the case and lift the disc out, holding it carefully by the edges.
- Do not use commercially available disc protection sheets or discs equipped with stabilizers, etc. These may damage the disc or cause breakdown of the internal mechanism.

#### Storage

- Do not expose discs to direct sunlight or any heat source.
- Do not expose discs to excess humidity or dust.
- Do not expose discs to direct heat from heaters.

#### Cleaning

- To remove fingermarks and dust, use a soft cloth and wipe in a straight line from the center of the disc to the circumference.
- Do not use any solvents, such as commercially available cleaners, anti-static spray, or thinner to clean discs.
- After using special disc cleaner, let the disc dry off well before playing it.

#### On Discs

- Never turn off the power and remove the unit from the car with a disc loaded.

#### CAUTION

For your safety, the driver should not insert or eject a disc while driving.

## 5. OPERATIONS

### Basic Operations

#### Note:

- Refer to the diagrams in "3. CONTROLS" when reading this chapter.

#### CAUTION

When the unit is turned on, starting and stopping the engine with its volume raised to the maximum level may harm your hearing. Be careful about adjusting the volume.

#### Power on / off

##### Notes:

- Start the engine before using this unit.
  - Be careful about using this unit for a long time without running the engine. If you drain the car's battery too far, you may not be able to start the engine and this can reduce the service life of the battery.
- Start the engine. The power button / knob illumination on the unit will light up.



- Press the [SRC /  $\phi$ ] button on the front panel or the remote control to turn on the power under standby mode. The unit goes back to the last status after power on.
- Press and hold the [SRC /  $\phi$ ] button on the front panel or the remote control to turn off the power.

#### Mute

Press the [MUTE] button on the remote control to mute the volume from the unit.

##### Note:

Doing the operation above again or adjusting volume will release muting.

#### Volume adjustment

Turn the [VOLUME] knob on the front panel or press the [ $\blacktriangle$ ] or [ $\blacktriangledown$ ] button on the remote control. The adjustable range of volume is 0 to 40.

#### CAUTION

While driving, keep the volume level at which external sounds can still be heard.

#### Playing source selection

Press [SRC /  $\phi$ ] button on the front panel or remote control repeatedly to choose desired playing source.

##### Notes:

Playing source selection means selecting which mode, such as **DISC** mode, **RADIO** mode and **AUX** mode.

#### Display system time

Press the [DISP] button on the front panel or [DISP] button on the remote control to switch the display information, system time and playing source.

#### RESET

##### Note:

\* When the [RESET] button is pressed, preset radio stations, titles, etc. stored in memory are cleared.

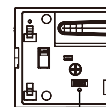

RESET

## System Setup

In any mode, press and hold [DISP] button to enter system setup. Press [◀◀] or [▶▶] button to select options, rotate the [VOLUME] knob to adjust.

### CLOCK

Press the [VOLUME] knob to enter clock setting mode, rotate the [VOLUME] knob to set clock, press [◀◀] or [▶▶] button to select hour or minute, press and hold the [VOLUME] knob to confirm.

### DX/LO (RADIO mode)

Rotate the [VOLUME] knob to choose radio local or distant at RADIO mode.

- **LO:** Only stations with strong signal can be received.
- **DX:** Stations with strong and weak signals can be received.

### AUX SENS (AUX mode)

Rotate the [VOLUME] knob to choose AUX Input sensitivity LOW, MID or HIGH at AUX mode.

### SELECT (BT mode)

This "SELECT" menu is intended to automatically paired by selecting a mobile phone was stored.

This unit can store three mobile phones. The mobile phone will be stored in paired order to the unit. The mobile phone can be stored up to three. The fourth mobile phone can not be stored. If you want to store a fourth mobile phone, please delete unwanted mobile phone from "DELETE" menu.

1. Rotate the [VOLUME] knob to choose the pair mobile phone name from the pairing list.
2. Press and hold the [VOLUME] knob to confirm.

### DELETE (BT mode)

1. Rotate the [VOLUME] knob to choose the paired mobile phone name from the pairing list.
2. Press and hold the [VOLUME] knob to confirm.

### DISCON (BT mode)

Disconnect currently connected mobile phone.

1. Rotate the [VOLUME] knob, mobile phone displays are currently connected.

2. Press and hold the [VOLUME] knob to disconnect.

### MIC SEL (BT mode)

Rotate the [VOLUME] knob to choose Microphone EXTERNAL or INTERNAL.

### MIC GAIN (BT mode)

Rotate the [VOLUME] knob to choose Mic gain: -5,-4,-3,-2,-1,0,1, 2, 3, 4, 5. You can change the gain of MIC when a telephone partner cannot hear your voice.

### TONE SEL (BT mode)

You can get mobile phone ring tone from the speaker.

Rotate the [VOLUME] knob to choose AUTO or INTERNAL.

- **AUTO:** Mobile phone ring tone from the speaker.
- **INTERNAL:** The unit original ring tone from the speaker.

### AUTO ANS (BT mode)

To answer incoming calls automatically.

Rotate the [VOLUME] knob to choose AUTO ANS ON or OFF.

### AUTO CON: ON/OFF (BT mode)

Automatically connects the mobile phone was last connected.

Rotate the [VOLUME] knob to choose AUTO CON ON or OFF.

### PIN CODE

Rotate and press the [VOLUME] knob to choose a 4-digit password. Press the [VOLUME] knob more than 1 seconds to confirm.

The PIN CODE default setting is "0000".

### SCRN SVR: ON/OFF

Rotate the [VOLUME] knob to choose SCRAN SVR (screen saver) ON or OFF.

### SCROLL: ON/OFF

For track information that is longer than the display panel:

When SCOLL is ON, the LCD will scroll the ID3 TAG information across the display, e.g.: TRACK->FOLDER->FILE->ALBUM->TITLE->ARTIST->TRACK->...

When SCROLL is OFF, the LCD will display one

## System Setup

of the ID3 TAG information, the default is TRACK, but user can adjust it to other ID3 TAG information by press [DISP] button.

### S-CTRL (IPOD mode) : ON/OFF

Rotate the [VOLUME] knob to choose S-CTRL(Simple control) ON or OFF.  
\* Refer to P9.

### DIMMER: ON/OFF

Rotate the [VOLUME] knob to choose DIMMER ON or OFF.

- **ON:** LCD dimmer is active when small light of vehicle is turned ON.
- **OFF:** LCD always maximum brightness regardless of the vehicle small light.

### REAR/S-W

Rotate the [VOLUME] knob to choose REAR or S-WOOFER (SUB-WOOFER).

### SW PHASE

Rotate the [VOLUME] knob to choose SUBWOOFER phase REVERSE or NORMAL.

### TEL-SW

Rotate the [VOLUME] knob to choose MUTE, ON or OFF.

- **MUTE:**

The sound from this unit is muted during telephone calls.

- **OFF:**

This unit continues normal operation even when the cellular phone is used.

- **ON:**

You can listen to your telephone calls from the speakers connected to this unit.

"When listening to your calls on your car speakers, you can adjust the volume by turning the [VOLUME] knob.

### BEEP: ON/OFF

Rotate the [VOLUME] knob to choose button beep sound ON or OFF.

### 12/24H

Rotate the [VOLUME] knob to choose time format: 12 or 24 hours.

## Audio Setup

Press the [↵] button to enter sound effect setting mode. First press shows current EQ. Rotate the [VOLUME] knob to changes BEAT EQ in this order:  
OFF -> B-BOOST -> IMPACT -> EXCITE -> CUSTOM

Rotate the [VOLUME] knob to changes CUSTOM, and press the [VOLUME] knob, the press [◀◀] or [▶▶] button to select it including: BAS-G -> BAS-F -> BAS-Q -> MID-G -> MID-F -> MID-Q -> TRE-G -> TRE-F, rotate the [VOLUME] knob to select a value.

BAS-G / MID-G / TRE-G: (-7)- (+7)

BAS-F: 50/100/200

BAS-Q: 0.7/1/1.4/2

MID-F: 500/1K/2K

MID-Q: 0.7/1/1.4/2

TRE-F: 5k/10k/15k

TRE-Q 0.7/1/1.4/2

Press the [↵] button, then press [◀◀] or [▶▶] button to select USER preset including:

BALANCE -> FADER -> M-B EX -> LPF(low pass filter) -> S-W VOL (Subwoofer Volume), rotate the [VOLUME] knob to select a value.  
BALANCE:LEFT 1-7->CENTER->RIGHT 1-7  
FADER:FRONT 1-7->CENTER->REAR 1-7  
M-BEX: ON/OFF  
LPF: THROUGH/60/90/120  
HPF: THROUGH/60/90/120  
SUBW VOL: (-6)-(+6)

## Radio Operations

### Select tuner as playing source

Press [SRC /  $\odot$ ] button once or more to enter RADIO mode.

### Selecting the radio band

Press the [BAND /  $\square$ ] button on the panel or [BAND / TOP] button on the remote control to select one radio band among FM1, FM2, FM3 and AM.

### Manual tuning

During manual tuning, the frequency will be changed in steps.

Press the [◀] or [▶] button on the panel to tune in a higher / lower station.

Press the [◀] or [▶] button on the remote control to select preset stations.

### Auto tuning

Press and hold the [◀] or [▶] button to seek a higher / lower station.

To stop searching, repeat the operation above or press other buttons having radio functions.

#### Note:

When a station is received, searching stops and the station is played.

### Preset scan

Preset scan receives the stations stored in preset memory in order. This function is useful when searching for a desired station in memory.

1. Press the [PS/AS] button.
2. When a desired station is tuned in, press the [PS/AS] button again to continue receiving that station.

#### Note:

Be careful not to press and hold the [PS/AS] button for 1 second or longer, otherwise the auto store function will begin and the unit starts storing stations.

### Auto store

Only stations with sufficient signal strength will be detected and stored in the memory. Press and hold the [PS/AS] button (1 sec.) to

start automatic station search.

To stop auto store, press other buttons having radio functions.

#### Notes:

1. After auto store, the previous stored stations will be overwritten.
2. The unit has 4 bands, such as FM1, FM2, FM3 and AM. FM3 and AM can store by AS function. Each band can store 6 stations, CZ302A can store 24 stations in total.

### Manual store

When one expected radio station has been detected, press and hold number button 1-6 to store it in the memory.

### Recall the stored stations

Press one numeric button among 1 to 6 on the panel to select the corresponding stored station.

### Local seeking

When LOCAL seeking is ON, only those radio stations with strong radio signal could be received.

To select LOCAL function, press and hold the [DISP] button on the front panel, then press [▶] button repeatedly until LO or DX displays on the screen, rotate the [VOLUME] knob to select Local or Distant mode.

#### Note:

The number of radio stations that can be received will decrease after the local seeking mode is ON.

## CD/MP3/WMA Operations

### This unit can playback MP3/WMA files

#### Notes:

- If you play a WMA file with active DRM (Digital Rights Management), there will be no audio.

#### To disable DRM

##### (Digital Rights Management)

When using Windows Media Player 9/10/11, click on TOOL -> OPTIONS -> COPY MUSIC tab, then under COPY SETTINGS, unclick the check box for COPY PROTECT MUSIC. Then, reconstruct files.

Personally constructed WMA files are used at your own responsibility.

### Precautions when creating MP3/WMA file

#### Usable sampling rates and bit rates

1. MP3: Sampling rate 8 kHz-48 kHz, Bit rate 8 kbps-320 kbps / VBR
2. WMA: Bit rate 8 kbps-320 kbps

#### File extensions

1. Always add a file extension ".MP3", ".WMA" to MP3, WMA file by using single byte letters. If you add a file extension other than specified or forget to add the file extension, the file cannot be played.
2. Files without MP3/WMA data will not play. The files will be played soundlessly if you attempt to play files without MP3/WMA data.
  - \* When VBR files are played, the play time display may differ the play location.
  - \* When MP3/WMA files are played, a little no sound part is caused between tunes.

#### Logical format (File system)

1. When writing MP3/WMA file on a CD-R disc or CD-RW disc, please select "ISO9660 level 1, 2 or Joliet" or Apple ISO as the writing software format. Normal play may not be possible if the disc is recorded on another format.
2. The folder name and file name can be displayed as the title during MP3/WMA play but the title must be within 32 single byte alphabetical letters and numerals (including an extension).
3. Do not affix a name to a file inside a folder having the same name.

### Folder structure

A disc with a folder having more than 8 hierarchical levels will be impossible.

### Number of files or folders

1. Up to 999 files can be recognized per folder.
  - Up to 3000 files can be played.
2. Tracks are played in the order that they were recorded onto a disc. (Tracks may not always be played in the order displayed on the PC.)
3. Some noise may occur depending on the type of encoder software used while recording.

### Eject function

Just pressing the [ $\triangle$ ] button, ejects the disc.

#### Notes:

- If you force a CD into before auto reloading, this can damage the CD.
- If a CD (12 cm) is left ejected for 15 seconds, the CD is automatically reloaded (Auto reload).

### Listening to a disc already loaded in the unit



Press the [SRC /  $\odot$ ] button to select the CD/MP3/WMA mode.

When the unit enters the CD/MP3/WMA mode, play starts automatically.

### Loading a CD

Insert a CD into the center of the CD SLOT with label facing up. The CD plays automatically after loading.

#### Notes:

- Never insert foreign objects into the CD SLOT.
- If the CD is not inserted easily, there may be another CD in the mechanism or the unit may require service.
- Discs without the  or  mark and CD-ROMs cannot be played by this unit.
- Some CD-R/CD-RW discs may not be usable.

### Pausing play

1. Press the [4] button to pause play. "PAUSE" appears in the display.
2. To resume CD play, press the [4] button again.

## CD/MP3/WMA Operations

### Displaying CD titles

This unit can display title data for MP3/WMA disc.

When SCROLL is OFF, each time you press the [DISP] button to change the title display.

### MP3/WMA disc

Track -> Folder -> File title -> Album -> Title -> Artist -> Track ...

### Notes:

- If MP3/WMA disc has no ID3 TAG, "NO TITLE" appears in the display.
- Only ASCII characters can be displayed in Tags.

### Selecting a track

#### Track-up

1. Press the [▶▶] button to move to the beginning of the next track.
2. Each time you press the [▶▶] button, the track advances to the beginning of the next track.
3. For MP3/WMA disc, press and hold the [6] button (1 sec.) to move ahead to +10 tracks.

#### Track-down

1. Press the [◀◀] button to move back to the beginning of the current track.
2. Press the [◀◀] button twice to move back to the beginning of the previous track.
3. For MP3/WMA disc, press and hold the [5] button (1 sec.) to move back to -10 tracks.

### Fast-forward/Fast-reverse

#### Fast-forward

Press and hold the [▶▶] button.

#### Fast-reverse

Press and hold the [◀◀] button.

- \* For MP3/WMA discs, it takes some time until the start of searching and between tracks. In addition, some error may occur in the play time.

### Folder Select

This function allows you to select a folder containing MP3/WMA files and start playing from the first track in the folder.

1. Press the [5] or [6] button.  
Press the [6] button to move the next folder. Press the [5] button to move the previous folder.
2. To select a track, press the [◀◀] or [▶▶] button.

### Search Function

1. Press the [MENU / ⏏] button to enter FOLD SCH mode. Press the [VOLUME] button to enter the folder list search mode.
2. Turn the [VOLUME] knob to select a folder.
3. Press the [VOLUME] button to enter the file list search mode. And then the track list appears in the display.
4. Turn the [VOLUME] knob to select a track.
5. Press the [VOLUME] knob to play.  
\* When play back MP3 / WMA file, this function is performed in the current folder.

### Top function

The top function resets the CD player to the first track of the disc. Press and hold the [4] button (1 sec.) to play the first track (track No. 1) on the disc.

- \* In case of MP3/WMA, the first track of the current folder will be played.

### Other various play functions

#### Scan play

This function allows you to locate and play the first 10 seconds of all the tracks recorded on a disc.

Press the [1] button to perform scan play.

#### Repeat play

This function allows you to play the current track repeatedly or play a track currently being played in the MP3/WMA folder repeatedly.

#### CD:

1. Press the [2] button once or more until "RPT ON" appears on the LCD to perform repeat play.
2. Press [2] button repeatedly until "RPT OFF" appears on the LCD to cancel repeat playback.

#### MP3/WMA:

1. Press the [2] button once or more until "TRACK RPT" appears on the display to perform repeat play, and "RPT" segment lights on.

## CD/MP3/WMA Operations

2. For MP3/WMA files, press [2] button repeatedly until "FOLDER RPT" appears on the display for folder repeat play.
3. Press [2] button repeatedly until "RPT OFF" appears on the display to cancel repeat playback, and "RPT" segment goes off.

### Random play

This function allows you to play all tracks recorded on a disc in a random order.

Press the [3] button to perform random play.

## USB Operations

1. Open the cover of the USB connector to the right. Insert a USB cable (CCA-755) into the USB connector. Insert a USB device into the USB cable.  
When connecting a USB device, the unit will read the files automatically.
2. To remove the USB device, you should first select another source or turn off the power, in order to avoid damaging the USB device. Then take off the USB device. Close the cover to the left.
3. Operation is same as MP3/WMA

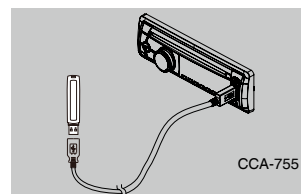

operation.

## iPod & iPhone Operations

### Connect

Connect an iPod or iPhone to the USB connector via CCA-748 cable.

When connecting a device, the unit will read the files automatically. The track information display on the screen once playback start.

### MENU

In the S-CTRL OFF mode, press [MENU / ⏏] button, rotate the [VOLUME] knob select "MUSIC" or "VIDEO".

Select "MUSIC", press the [VOLUME] knob, then rotate the [VOLUME] knob to show PLAY LISTS / ARTISTS / ALBUMS / GENRES / SONGS / COMPOSERS, press and rotate the [VOLUME] knob to select a desired option, then press the [VOLUME] knob to confirm.

Select "VIDEO", press the [VOLUME] knob, then rotate the [VOLUME] knob to show MOVIES / MUSIC VIDEOS / TV SHOWS VIDEO PODCASTS / RENTALS, press and

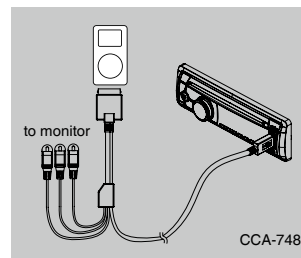

rotate the [VOLUME] knob to select a desired option, then press the [VOLUME] knob to confirm.

### NOTE:

VIDEO MENU item is different by the model of connected iPod and language setting.



## iPod & iPhone Operations

### Repeat play

This function allows you to play the current track repeatedly or play all tracks in your iPod/iPhone repeatedly.

1. Press the [ **2** ] button once or more until "RPT ON" appears on the LCD to perform repeat play.
2. Press [ **2** ] button repeatedly until "RPT OFF" appears on the LCD to cancel repeat playback.

### Random play

This function allows you to play all tracks recorded on a disc in a random order.

1. Press [ **3** ] button repeatedly until "ALBUM RDM" appears on the LCD for album random play.
2. Press the [ **3** ] button once or more until "SONG RDM" appears on the LCD to perform random play.
3. Press [ **3** ] button repeatedly until "RDM OFF" appears on the LCD to cancel random playback.

### Setting iPod simple control mode

Use this function if you wish to operate through your iPod connected to this unit via the USB cable.

- \* The factory default setting is "OFF".
1. Press and hold [ **DISP** ] button to enter system setup.
  2. Press [ **◀▶** ] or [ **▶▶** ] button to select "S-CTRL".
  3. Rotate the [ **VOLUME** ] knob to select "ON" or "OFF".
    - **ON**: Operations are made through your iPod.
    - **OFF**: Operations cannot be made through your iPod.

## Bluetooth Operations

The Bluetooth allows you to utilize your car's built-in audio system for wireless mobile phone or music handsfree communication. Some Bluetooth mobile phones have the audio features, and some portable audio players support Bluetooth feature. This system can play audio data stored in a Bluetooth audio

### Notes:

- When performing iPod operations using simple control mode, make the operations slowly. If repetitive operations are performed too quickly, Unforeseen errors may occur.
- When performing iPod operations using simple control mode, please do not operate the iPod and the unit at the same time, otherwise there may be unexpected event happened.
- Some iPod models do not support this function. Consult your nearest Clarion dealer or website to confirm which models do not support this function.

### iPod menu alphabet search

This function searches the subfolders of desired alphabetical letters.

1. Press the [ **MENU** / **↵** ] button to select the iPod menu mode.
2. Press the [ **VOLUME** ] knob to switch between categories.  
MUSIC, PLAYLIST, ARTISTS, ALBUMS, GENRES, SONGS, COMPOSERS  
VIDEO: MOVIES, MUSIC VIDEOS, TV SHOWS VIDEO  
PODCASTS, RENTALS
3. Press the [ **VOLUME** ] knob. (The contents of the category are displayed.)
4. Press and hold the [ **DISP** ] button (1 sec.).
5. Rotate the [ **VOLUME** ] knob to select the desired letter to search.
6. Press the [ **DISP** ] button again to next perform search.
7. Press the [ **VOLUME** ] knob to confirm.

### Notes:

- Do not leave the microphone of Bluetooth handsfree in the places with wind passing

## Bluetooth Operations

such as air outlet of the air conditioner, etc. This may cause a malfunction.

- If leave it in the places subjected to direct sun, high temperature can cause distortion, discoloration which may result in a malfunction.
- This system will not operate or may operate improperly with some Bluetooth audio players.
- **Clarion** cannot guarantee the compatibility of all mobile phones together with unit.
- Audio playback will be set to the same volume level as set during telephone call. This might cause problems, if extreme volume level is set during telephone call.

### Handsfree Operations

#### Pairing

1. Turn on Bluetooth function of your mobile phone.
2. Enter mobile phone's Bluetooth setup menu.
3. Search for new Bluetooth devices.
4. Select **CZ302A** from the pairing list on the mobile phone.
5. Enter "0000" as the password (The password default setting is "0000").
6. After pairing successfully, the unit will enter Bluetooth mode automatically, and "CONNECTED" will appear on the LCD.
7. The unit can connect three units.

#### Making a call

##### Operation from Bluetooth menu

Press the [ **SRC** / **⏏** ] button to switch the source to "BLUETOOTH". Press [ **MENU** / **↵** ] button to select a way to make outgoing call:

##### • Dial Number

1. Press the [ **MENU** / **↵** ] button.
2. Rotate the [ **VOLUME** ] knob on to switch: "DIAL NUM".
3. Press the [ **VOLUME** ] knob to confirm the selection.
4. Rotate the [ **VOLUME** ] knob to select a number, press the knob to confirm and ready to input the next digit. Repeat the above until all numbers inputted.
5. Press the [ **BAND** / **⏏** ] button to dial.
6. Press [ **MENU** / **↵** ] to terminate call.

##### • Dialed/Missed/ Received

You can search any Dialed/Missed/Received .

1. Rotate the [ **VOLUME** ] knob to select "DIALED", "MISSED", "RECEIVED".
2. Press the [ **VOLUME** ] knob to enter the selected call history.
3. Rotate the [ **VOLUME** ] knob to scroll the contacts.
4. When the contact name or mobile phone No. is displayed, press the [ **VOLUME** ] knob to call the mobile phone No. of that contact.
  - \* Press the [ **MENU** / **↵** ] button to end the call.

##### • Call from Phonebook

You can search the contact name in the phonebook and make call.

1. Rotate the [ **VOLUME** ] knob to select "USER PBK".
2. Press the [ **VOLUME** ] knob to enter the selected phonebook.
3. Rotate the [ **VOLUME** ] knob to scroll the contacts.
4. The phone number and the name to scroll display. When the contact name is displayed, press the [ **VOLUME** ] knob to call the mobile phone No. of that contact.
  - \* Press the [ **MENU** / **↵** ] button to end the call.

### Notes:

- Some mobile phones may not be able to transfer data of Phonebook.
- After **RESET**, please wait few minutes until data transferred following to the Bluetooth mode selection. During that, "PBK UPDATE" is on the display.

##### • Redial

You can call last dialed number.

Press and hold the [ **BAND** / **⏏** ] button (1sec).

##### • Call Transfer

You can switch Handsfree call and mobile phone call.

Press the [ **BAND** / **⏏** ] button during call.

##### • Answering a call

You can answer an incoming call by pressing the [ **BAND** / **⏏** ] button.

\* Press the [ **MENU** / **↵** ] button to reject an incoming call.

## Bluetooth Operations

### Audio Streaming Operations What is audio streaming?

Audio streaming is a technique for transferring audio data such that it can be processed as a steady and continuous stream. Users can stream music from their external audio player to their car stereo wirelessly and listen to the tracks through the car's speakers. Please consult your nearest **Clarion** dealer for more information on the product of wireless audio streaming transmitter offered.

#### CAUTION

**Please avoid operating your connected mobile phone while audio streaming as this may cause noise or sound choppy on the song playback.**

**Audio streaming may or may not resume after telephone interrupt as this is dependent on mobile phone. System will always return to Radio mode if audio streaming is disconnected.**

#### Note:

Be sure to read the chapter "Pairing before proceeding."

### Play / Pause a track

1. Push the [ 4 ] button to pause audio playback.
2. To resume audio playback, push the [ 4 ] knob again.

### Selecting a track

#### Track-up

1. Press the [ >>1 ] button to move to the beginning of the next track.

## AUX Operations

Press [SRC /  $\oplus$ ] button on the panel or remote control to select "AUX". AUX is just for audio content with 3.5mm Jack connector plugged into audio-in socket on the front panel.

2. Each time the [ >>1 ] button is pressed, playback proceeds to another track in the advancing direction.

#### Track-down

1. Press the [ <<<1 ] button to move to the beginning of the previous track.
2. Each time the [ <<<1 ] button is pressed, playback proceeds to previous track in the reverse direction.

#### Note:

Playing order will depend on Bluetooth audio player. When [ <<<1 ] button is pressed, some A2DP devices will restart the current track depends on the duration of playback. During music streaming playback, "A2DP" will be shown on the display. When A2DP and HFP device is disconnected, "DISCONNECT" will be shown on the display and return to previously selected audio source. Some Bluetooth audio players may not have play / pause synchronized with this unit. Please make sure both device and main unit are in the same play / pause status in **BT MUSIC** mode.

### ID3TAG display

During music streaming playback, for music information that is longer than the display panel:

When SCROLL is ON, the LCD will display ID3 TAG information cyclicly, e.g: ALBUM->TITLE->ARTIST ...

When SCROLL is OFF, the LCD will display one of the ID3 TAG information, the default is TRACK, but user can adjust it to other ID3 TAG information by press [ DISP ] button.

### AUX Input sensitivity setting

1. Press and hold the [DISP] button (1 sec.).
2. Turn the [VOLUME] knob to select "AUX SENS".
3. If the output level of connected external audio player is "HIGH", rotate [VOLUME] knob and choose "LOW". And if the output level is "LOW", choose "HIGH".

## 6. TROUBLE SHOOTING

### GENERAL

Problem	Cause	Measure
Unit can not power on.	Unit fuse blown.	Replace with new fuse of correct rating.
	Car battery fuse blown.	Replace with new fuse of correct rating.
Unit can not power on.  Nothing happens when buttons are pressed.  Display is not accurate.	The microprocessor has malfunctioned due to noise, etc.	Turn off the power and remove the DCP. Press the [RESET] button with a thin rod.  <b>Note:</b> When the [RESET] button is pressed, turn off the ACC power.*
		* When the [RESET] button is pressed, preset radio stations, titles, etc. stored in memory are cleared.
Remote control does not work.	Battery depleted.	Change the battery.
	Battery installed incorrectly.	Install the battery correctly.
No/low audio output.	Improper audio output connection.	Check wiring and correct.
	Volume set too low.	Increase volume level.
	Speakers damaged.	Replace speakers.
	Heavily biased volume balance.	Adjust the channel balance to center position.
Poor sound quality or distortion.	Speaker wiring is in contact with metal part of car.	Insulate all speaker wiring connections.
	Non-standard disc used.	Use a standard disc.
	Speaker power rating does not match unit.	Replace speakers.
Tel-Mute malfunction.	Wrong connections.	Check wiring and correct.
	Speaker is shorted.	Check wiring and correct.
Unit resets itself when engine is off.	MUTE wire is grounded.  Incorrect connection between ACC and Battery.	Check the MUTE wiring and correct.  Check wiring and correct.

### DISC Player

Problem	Cause	Measure
Disc cannot be loaded.	Another disc is already loaded.	Eject the disc before loading the new one.
	There is an object install inside the unit.	Remove the object inside the unit.
Sound skips or is noisy.	Compact disc is dirty.	Clean the compact disc with a soft cloth.
	Compact disc is heavily scratched or warped.	Replace with a compact disc with no scratches.
Sound is bad when power is first turned on.	Condensation may form on the internal lens when the car is parked in a humid place.	Let dry for about 1 hour with power on.

## USB Devices

Problem	Cause	Measure
USB device cannot be inserted.	The USB device has been inserted with wrong direction. The USB connector is broken.	Reversing the connection direction of the USB device, try it again. Replace with a new USB device.
USB device is not recognized.	The USB device is damaged. Connectors are loose.	Disconnect the USB device and reconnect. If the device is still not recognized, try replacing with a different USB device.
No sound heard with the display "No File" shown.	No MP3/WMA file is stored in the USB device.	Store these files properly in the USB device.
Sound skips or is noisy.	MP3/WMA files are not encoded properly.	Use MP3/WMA files encoded properly.

## Bluetooth

Problem	Cause	Measure
Cannot pair the Bluetooth enabled device with the car audio system.	The device does not support the profiles required for the system. The Bluetooth function of the device is not enabled.	Use another device to connect. Refer to the user manual of the device for how to enable the function.
The audio quality is poor after connection with a Bluetooth-enabled device.	The internal microphone gain is not set correctly. The external microphone is not set correctly nor properly positioned.	Adjust the gain of the internal microphone in System Setup. Adjust the gain and position of the external microphone. For example, stick the microphone onto the dashboard so it is close to the driver.

## 7. ERROR DISPLAYS

If an error occurs, one of the following displays is displayed. Take the measures described below to solve the problem.

Display	Cause	Measure
ERROR 3	Disc is inserted incorrectly. The disc format is not supported.	Eject the disc then reload it properly. Try another disc.
ERROR 5	This is a failure of deck's mechanism.	Consult your store of purchase.

If an error display other than the ones described above appears, press the [RESET] button. If the problem persists, turn off the power and consult your store of purchase.

- \* When the [RESET] button is pressed, preset radio stations, titles, etc. stored in memory are cleared.

## 8. SPECIFICATIONS

### FM Tuner

Frequency range: 87.5-108.0MHz  
Usable sensitivity: 8dBf  
Frequency response: 30Hz-15kHz  
Stereo separation: 30dB(1kHz)  
Signal/noise ratio: >55dB

### AM Tuner

Frequency range: 531-1629kHz  
Usable sensitivity (S/N=20dB): 30dBμ

### CD Player

System: Disc digital audio system  
Frequency response: 20Hz-20kHz  
Signal/noise ratio: >94dB  
Total harmonic distortion: Less than 0.1% (1kHz)  
Channel separation: >60dB

### MP3/WMA mode

MP3 sampling rate: 8 kHz to 48 kHz  
MP3 bit rate: 8 kbps to 320 kbps / VBR  
WMA bit rate: 8 kbps to 320 kbps  
Logical format: ISO9660 level 1,2  
Joliet file system

### USB

Specification: USB 1.0/2.0  
Playable audio format:  
MP3(.mp3): MPEG 1/2/Audio Layer-3  
WMA(.wma): Ver 7/8/9, 1/9, 2

### Bluetooth

Specification: Bluetooth Ver. 2.0+EDR  
Profile: HFP (Hands-free Profile)  
A2DP (Advanced Audio Distribution Profile)  
AVRCP (AV Remote Control Profile)  
PBAP (Phone Book Access Profile)  
Send/Receive Sensitivity: Class 2

### Audio Amplifier

Maximum power output:  
180W (45W x 4)  
Speaker impedance: 4Ω (4 to 8 Ω allowable)

### Input

Audio input sensitivity:  
High: 320mV (at 1V output)  
Mid: 650mV (at 1V output)  
Low: 1.3V (at 1V output)  
(input impedance 10 kΩ or greater)  
Aux-in level: ≤2V

### General

Power supply voltage:  
14.4VDC (10.8 to 15.6V allowable),  
negative ground  
Pre-Amp output voltage:  
2.0V (CD play mode: 1kHz, 0dB, 10kΩ load)  
Fuse: 15A  
Dimensions of the Main Unit:  
188mm Width × 58mm Height × 190mm Depth  
Weight of the Main Unit: 1.30kg

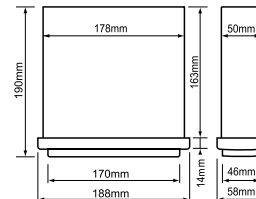

### Notes:

- Specifications and design are subject to change without notice for further improvement.

# 9. INSTALLATION / WIRE CONNECTION GUIDE

## CONTENTS

1) Before Starting .....	12
2) Package Contents .....	12
3) General Cautions .....	12
4) Cautions on Installation .....	12
5) Installing the Source Unit .....	12
6) Removing the Source Unit .....	13
7) Wiring and Connections .....	14
8) Connecting the Accessories .....	14

### 1) Before Starting

1. This set is exclusively for use in cars with a negative ground 12 V power supply.
2. Read these instructions carefully.
3. Be sure to disconnect the battery "terminal" before starting. This is to prevent short circuits during installation. (Figure 1)

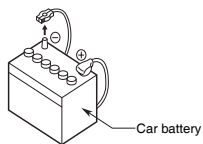

Figure 1

### 2) Package Contents

Source unit .....	1	L-key .....	2
Front panel .....	1	Wire connector .....	1
Trim ring .....	1	DCP case .....	1
Mounting bracket .....	1	Owner's manual .....	1
Screw M4x5 mm .....	1	Strap .....	1
Screws M5x6 mm .....	4	Special screw (Front panel lock) .....	1

### 3) General Cautions

1. Do not open the case. There are no user serviceable parts inside. If you drop anything into the unit during installation, consult your dealer or an authorized Clarion service center.
2. Use a soft, dry cloth to clean the case. Never use a rough cloth, thinner, benzine, or alcohol etc. For tough dirt, apply a little cold or warm water to a soft cloth and wipe off the dirt gently.

### 4) Cautions on Installation

1. Prepare all articles necessary for installing the source unit before starting.
2. Install the unit within 30° of the horizontal plane. (Figure 2)
3. If you have to do any work on the car body, such as drilling holes, consult your car dealer beforehand.
4. Use the enclosed screws for installation. Using other screws can cause damage. (Figure 3)

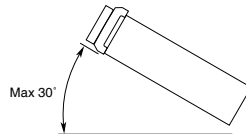

Figure 2

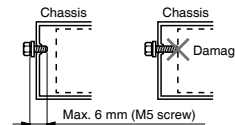

Figure 3

### 5) Installing the Source Unit

1. Place the mounting bracket into the instrument panel, use a screwdriver to bend each stopper of the mounting bracket inward, then secure the stopper.
2. Wire as shown in Section 7) .
3. Insert the source unit into the mounting bracket until it locks.
4. Take care of the top and bottom of the trim ring and mount it so that all the hooks are locked.

#### Notes:

1. Some car models require special mounting kits for proper installation. Consult your **Clarion** dealer for details.
2. Fasten the front stopper securely to prevent the source unit from coming loose.

#### • Console opening dimensions

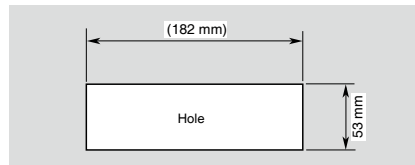

## Notes of installation

1. Before installation, please make sure proper connections are conducted and the unit operates normally. Improper connection may result in damage to the unit.
2. Use only accessories designed and manufactured for this unit and other unauthorized accessories may result in damage to the unit.
3. Before installation, please fasten all power cables.
4. DO NOT install the unit in the place where close to hot area to prevent damage to electrical components such as the laser head.
5. Install the unit horizontally. Installing the unit more than 30 degree vertically may result in worse performance.
6. To prevent electric spark, connect the

positive pole first and then the negative pole.

7. DO NOT block the cooling fan exit to ensure sufficient heating dissipation of this unit, or it may result in damage to this unit.

## Unit Installation

### Method A

1. Insert mounting bracket into dash board, choose appropriate mounting tab according to the gap width, bending the mounting tab outwards with a screwdriver to fix the mounting bracket in place.
2. Slide the unit into the bracket until you hear a click sound.

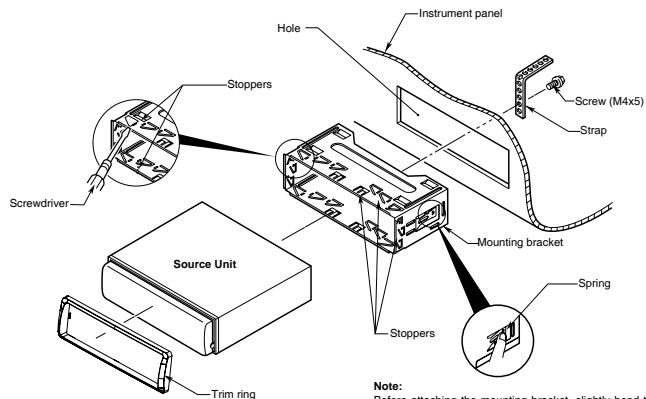

**Note:**  
Before attaching the mounting bracket, slightly bend the spring toward the inside with your fingers and attach it to the side of car.

## Method B

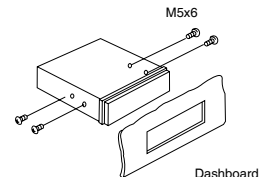
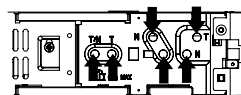

Mounting Frame

Dashboard

1. Insert this unit directly to the opening of the dashboard.
2. Place M5x6 cylindrical screw through the holes of the mounting frame located inside the opening to holes of the unit and fasten the screws to left & right.

## Trim ring installation

Attach the trim ring around the front panel. Take care of the top and bottom of the trim ring and mount it so that all the hooks are locked.

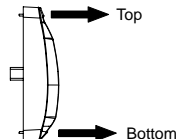
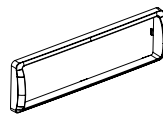

## 6) Removing the Source Unit

### Disassemble trim ring

1. Push the trim ring to right and pull out the right part.

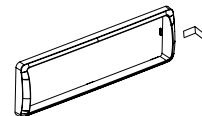

2. Push the trim ring to left and pull out the left part.

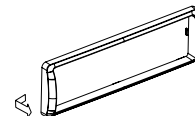

### Disassemble the unit

1. Switch off the power.
2. Remove the panel.
3. Remove the trim ring.
4. Insert the removal keys straight back until they lock, then pull the unit out.
5. Disconnect all the wires.

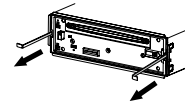

## 7) Wiring and Connections

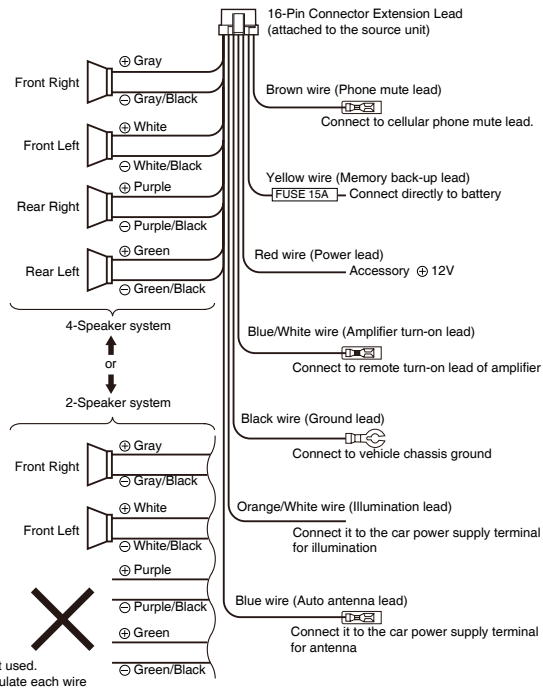
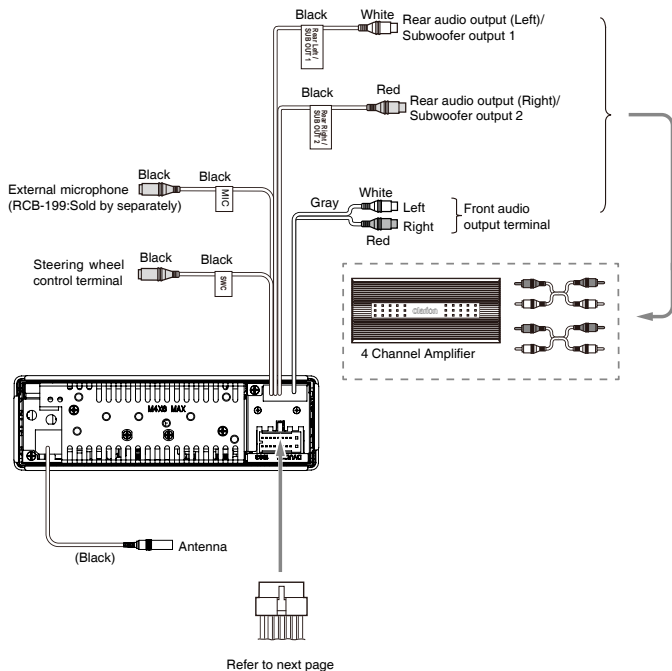

## 8) Connecting the Accessories

### • Connecting to the external amplifier

External amplifiers can be connected to the 4 channel RCA output connections. Ensure that the connectors are not grounded or shorted to prevent damage to the unit.

# Clarion Co., Ltd.

---

All Rights Reserved. Copyright © 2011: Clarion Co., Ltd.

Printed in China / Diketak di Cina / 중국 인쇄 / 中国印刷 / พิมพ์ในประเทศไทยจีน

PN: 127075013939