

clarion®

Owner's manual

使用说明书

คู่มือผู้ใช้

Petunjuk pengguna

CZ509A

Bluetooth® CD/USB/MP3/WMA/AAC RECEIVER

Bluetooth® CD/USB/MP3/WMA/AAC 接收器

เครื่องรับ **CD/USB/MP3/WMA/AAC** พร้อม **Bluetooth®**

UNIT PENERIMA CD/USB/MP3/WMA/AAC Bluetooth®

Thank you for purchasing this **Clarion** product.

- * Please read this owner's manual in its entirety before operating this equipment.
- * Check the contents of the enclosed warranty card and keep it carefully with this manual.

Contents

1. FEATURES	3
2. PRECAUTIONS	4
3. CONTROLS	6
Names of the Buttons and Their Main Functions	6
4. DCP	8
5. REMOTE CONTROL	9
Functions of Remote Control Unit Buttons	9
Inserting the Battery	10
6. OPERATIONS	11
Basic Operations	11
Radio Operations	14
CD/MP3/WMA/AAC Operations	15
Bluetooth Operations	19
Operations Common to Each Mode	23
7. ACCESSORIES	26
USB/MTP Operations	26
iPod Operations	28
8. TROUBLESHOOTING	31
9. ERROR DISPLAYS	33
10. SPECIFICATIONS	34
11. OTHERS	34

1. FEATURES



- Built in Bluetooth® handsfree (HFP) and Audio Streaming (A2DP & AVRCP)
- BBE MP for compressed audio improvement
- BEAT EQ for Sound Adjustment

2. PRECAUTIONS

CAUTION

USE OF CONTROLS, ADJUSTMENTS, OR PERFORMANCE OF PROCEDURES OTHER THAN THOSE SPECIFIED HEREIN, MAY RESULT IN HAZARDOUS RADIATION EXPOSURE.

THE COMPACT DISC PLAYER SHOULD NOT BE ADJUSTED OR REPAIRED BY ANYONE EXCEPT PROPERLY QUALIFIED SERVICE PERSONNEL.

CHANGES OR MODIFICATIONS NOT EXPRESSLY APPROVED BY THE MANUFACTURER FOR COMPLIANCE COULD VOID THE USER'S AUTHORITY TO OPERATE THE EQUIPMENT.

Flip Down Panel

This unit uses a flip-down structure that makes possible large-size displays.

CAUTION

When opening and closing the FLIP DOWN PANEL, be careful not to catch your fingers. They could be injured.

1. Always use this unit with the FLIP DOWN PANEL closed.
2. Do not force operations or use this device abnormally when opening or closing the FLIP DOWN PANEL.
3. Do not use the FLIP DOWN PANEL as a tray to place objects on when it is open.
4. When closing the FLIP DOWN PANEL, do not press the [OPEN] button.
 - * Press the center of the DCP to close.

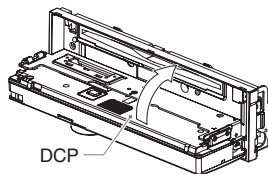

5. Strong impacts to the operating or display section can cause damage or deformation.
6. If the FLIP DOWN PANEL does not open fully, gently open it with your hand.

Handling Compact Discs

- Compared to ordinary music CDs, CD-R and CD-RW discs are both easily affected by high temperature and humidity and some of CD-R and CD-RW discs may not be played. Therefore, do not leave them for a long time in the car.
- Never stick labels on the surface of the compact disc or mark the surface with a pencil or pen.

Display Screen

In extreme cold, the screen movement may slow down and the screen may darken, but this is normal.

The screen will recover when it returns to normal temperature.

3. CONTROLS

Names of the Buttons and Their Main Functions

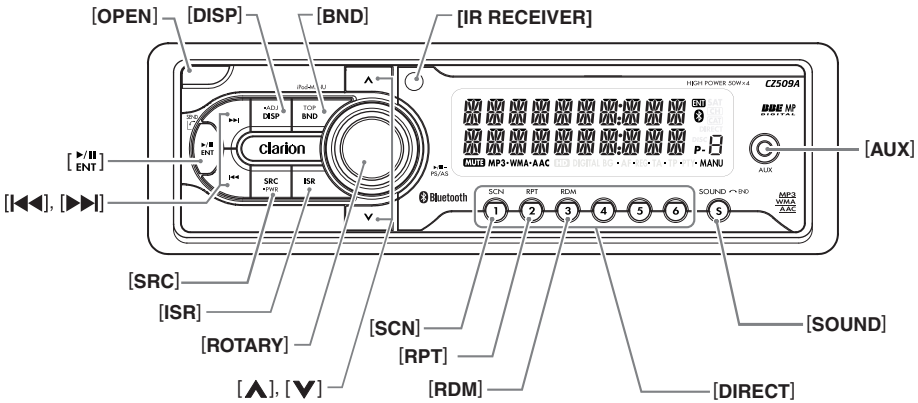

With the FLIP DOWN PANEL opened

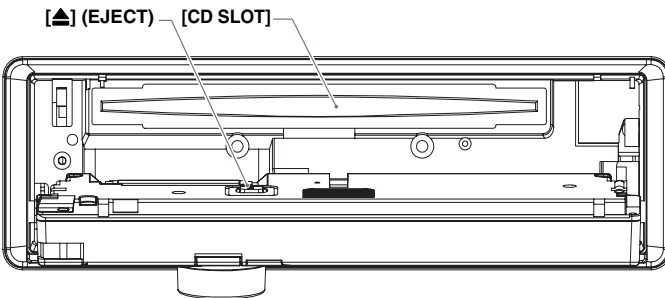

[OPEN] button

- Deeply push in [OPEN] button to unlock the flip down panel.

[DISP] button

- Switch the display indication.

[BND] button

- Change bands, or select seek tuning or manual tuning while in the radio mode.

[IR RECEIVER]

- Receiver for remote control unit.
(Operating range: 30° in all directions)

[AUX] input jack

- Input jack for connecting external device.

[SOUND] button

- Press to switch to the sound adjust mode.

[DIRECT] buttons

- Store radio stations in memory or recall it directly while in radio mode.

[RDM] button

- Perform random play while in CD/MP3/WMA/AAC/USB/iPod mode.

[RPT] button

- Perform repeat play while in CD/MP3/WMA/AAC/USB/iPod mode.

[SCN] button

- Perform scan play for 10 seconds of each track while in CD/MP3/WMA/AAC/USB mode.

[▲] (UP), [▼] (DN) buttons

- Select folders while in MP3/WMA/AAC/USB mode.

[ROTARY] knob

- Rotate to adjust the volume.

[ISR] button

- Recall ISR radio station in memory.
- Press and hold the button (2 sec.) to store current station into ISR memory (radio mode only).

[SRC] button

- Turn the power on/off.

[◀◀], [▶▶] buttons

- Commence fast-forward or fast-reverse mode.

[▶/|| ENT] button

- Perform preset scan while in the radio mode.
- Play or pause a track while in CD/MP3/WMA/AAC/USB/iPod mode.

[▲] (EJECT) button

- Press to eject disc.

[CD SLOT]

- Insert CDs here.

4. DCP

The control panel can be detached to prevent theft. When detaching the control panel, store it in the DCP (DETACHABLE CONTROL PANEL) case to prevent scratches.

We recommend taking the DCP with you when leaving the car.

Removing the DCP

1. Press the [SRC] button (1 sec.) to turn off the power.
2. Deeply push in [OPEN] button to unlock the flip down panel.
If the flip down panel does not open fully, gently open it with your hand.

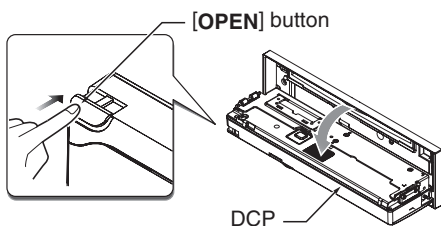

3. Pull the DCP toward you and remove it.

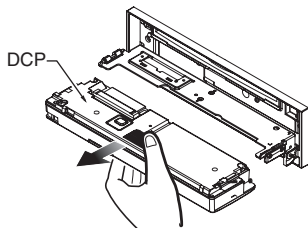

4. Close the HOLD FLAP.

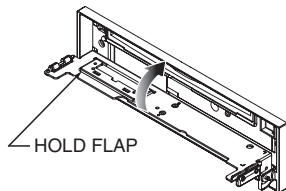

⚠ CAUTION

Be sure to close the HOLD FLAP for safety when removing the DCP.

Attaching the DCP

1. Insert the right side of the DCP into the main unit.

2. Insert the left side of the DCP into the main unit.

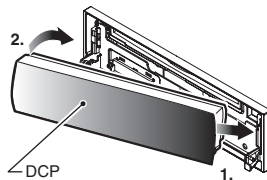

Storing the DCP in the DCP Case

Hold the DCP, in the orientation as shown in the figure below, and put it into the supplied DCP case. (Ensure the DCP is in the correct orientation.)

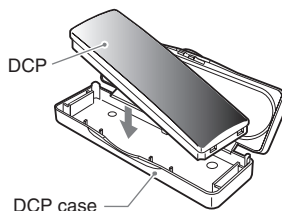

⚠ CAUTION

- The DCP can easily be damaged by shocks. After removing it, be careful not to drop it or subject it to strong shocks.
- If the FLIP DOWN PANEL is kept open, the DCP may drop due to vibration of the car. This results in damage to the DCP. So close the FLIP DOWN PANEL or remove the DCP to store into the case.
- The connector connecting the source unit and the DCP is an extremely important part. Be careful not to damage it by pressing on it with fingernails, screwdrivers, etc.

Note:

- If the DCP is dirty, wipe off the dirt with a soft, dry cloth only.

5. REMOTE CONTROL

Functions of Remote Control Unit Buttons

* Some buttons on the remote control unit have different functions from the corresponding buttons on the main unit.

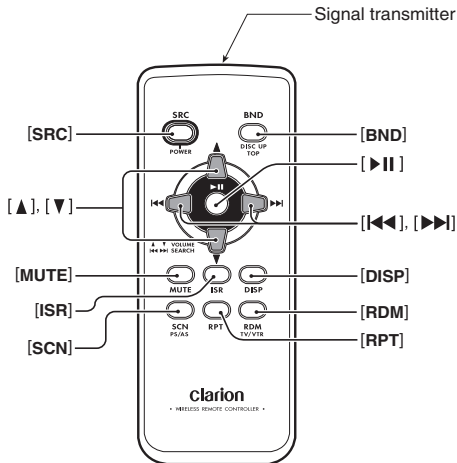

● Shared modes

[SRC] button

- Press the button to turn on the power.
Press and hold the button (1 sec.) to turn off the power.
- Use to alternate operation mode among the various modes.

[▲], [▼] buttons

- Increases and decreases volume.

[MUTE] button

- Turns mute function on and off.

[ISR] button

- Recalls ISR radio station stored in memory.
- Press and hold the button (2 sec.) to store current station in ISR memory (radio mode only).

[DISP] button

- Press to select the desired display.

● Radio mode

[BND] button

- Switches reception band.

[◀◀], [▶▶] buttons

- Moves preset channels up and down.

[SCN] button

- Press to perform preset scan.
- Press and hold the button (2 sec.) to perform auto store.

● CD/MP3/WMA/AAC and USB/MTP modes

[BND] button

- Press to play the first track.

[◀◀], [▶▶] buttons

- Press to select tracks.
- Press and hold the button (1 sec.) to perform fast-forward/fast-reverse (Except DRM file).

[▶||] button

- Switches between playback and pause.

[SCN] button

- Press to perform scan play.
- When in MP3/WMA/AAC and USB/MTP modes, press and hold the button (1 sec.) to perform folder scan play.

[RPT] button

- Press to perform repeat play.
- When in MP3/WMA/AAC and USB/MTP modes, press and hold the button (1 sec.) to perform folder repeat play.

[RDM] button

- Press to perform random play.
- When in MP3/WMA/AAC and USB/MTP modes, press and hold the button (1 sec.) to perform folder random play.

● iPod mode

[◀◀], [▶▶] buttons

- Press to move the tracks up and down.
- Press and hold the button (1 sec.) to perform fast-forward/fast-reverse.

[▶||] button

- Switches between playback and pause.

[RPT] button

- Press to perform repeat play.

[RDM] button

- Press to perform random play.
- Press and hold the button (1 sec.) to perform all random play.

Inserting the Battery

- ① Turn over the remote control unit and slide the cover in the direction indicated by the arrow in the illustration.
- ② Insert the battery (CR2025) into the insertion guides, with the printed side (+) facing upwards.
- ③ Press the battery in the direction indicated by the arrow so that it slides into the compartment.
- ④ Replace the cover and slide in until it clicks into place.

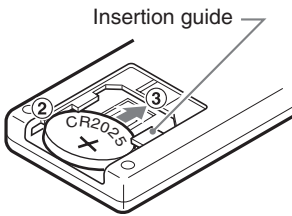
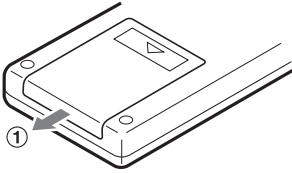

Notes:

Misuse may result in rupture of the battery, producing leakage of fluid and resulting in personal injury or damage to surrounding materials. Always follow these safety precautions:

- Use only the designated battery.
- When replacing the battery, insert properly, with +/- polarities oriented correctly.
- Do not subject battery to heat, or dispose of in fire or water. Do not attempt to disassemble the battery.
- Dispose of used batteries properly.

6. OPERATIONS

Note:

- Be sure to read this chapter referring to the front diagrams of chapter "3. CONTROLS" on page 6.

Basic Operations

⚠ CAUTION

Be sure to lower the volume before switching off the unit power or the ignition key. The unit remembers its last volume setting.

Turning on/off the power

Note:

1. Press the [SRC] button to turn on the power.
2. Press and hold the [SRC] button (1 sec.) to turn off the power for the unit.

Note:

• System check

The first time this unit is turned on after the wire connections are completed, it must be checked what equipment is connected. When the power is turned on, the "SYSTEM CHECK" appears in the display, then the unit returns to the clock display mode. The system check starts within the unit. Then press the [SRC] button again, the unit turn to the radio mode.

Selecting a mode

1. Press the [SRC] button to change the operation mode.
2. Each time you press the [SRC] button, the operation mode changes in the following order:
Radio → CD/MP3/WMA/AAC → USB/MTP/iPod → BLUETOOTH → AUX → Radio...
* iPod/MTP can connect to this unit via USB cable.

Adjusting the volume

1. Turning the [ROTARY] knob clockwise increases the volume; turning it counterclockwise decreases the volume.
* The volume level is from 0 (minimum) to 33 (maximum).

Switching the display

Press the [DISP] button to select the desired display.

Sound Adjustment

You can adjust a sound effect or tone quality to your preference.

To change sound setting

1. Press the [SOUND] button to switch to the sound adjustment selection display.
* The factory default sound setting is "BEAT EQ".
2. Then press the [◀◀] or [▶▶] button to select the sound adjustment mode.
Each time you press the [◀◀] or [▶▶] button, the sound adjustment mode changes as following order:
"BEAT EQ" ↔ "M-B EX" ↔ "BALANCE" ↔ "FADER" ↔ "LPF" ↔ "S-W VOL" ↔ "HPF"
* In the case of display blinking "ENT", you can press the [ENT] button to adjust the setting value.
3. Press the [▲] or [▼] button to adjust the selected audio mode.
4. After completing settings, press the [SOUND] button to return to the previous mode.

● Setting the BEAT EQ

This unit is provided with 4 types of sound tone effects stored in memory.

Select the one you prefer.

* The factory default setting is "OFF".

2-1. Select "BEAT EQ".

- 3-1. Each time you press the [▲] or [▼] button, the tone effect changes in the following order:

"CUSTOM" ↔ "EXCITE" ↔ "IMPACT" ↔ "B-BOOST" ↔ "OFF"

CUSTOM : user custom

EXCITE : bass and treble emphasized
mid emphasized

IMPACT : bass and treble emphasized

B-BOOST : bass emphasized

OFF : no sound effect

Basic Operations

When "CUSTOM" is set:

- 3-1. Press the [P/ENT] button.
- 3-2. Press the [◀◀] or [▶▶] button to select the "BASS, MID" or "TREBLE" mode to adjust.
- 3-3. If you want to set the flat, press the [P/ENT] button to return to the "CUSTOM" mode, then press and hold the [P/ENT] button for 1 second or longer, bass/mid/treble characteristics become flat.

When "EXCITE/IMPACT/B-BOOST" is set:

- 3-1. Press the [P/ENT] button.
- 3-2. Press the [▲] or [▼] button to adjust the setting in the range of -3 to +3.
* The factory default setting is "0".
- 3-3. Press the [P/ENT] button to return to the previous mode.

● Adjusting the BASS/MID/TREBLE

This adjustment can be performed only when the BEAT EQ is set to "CUSTOM".

Note:

- While connected with the external amplifiers, please do not set the "BASS/MID/TREBLE" in the maximum level. Otherwise the speakers may be damaged.

- 3-1. Press the [P/ENT] button.
- 3-2. Press the [◀◀] or [▶▶] button to select as following order.
"BASS<G>" ↔ "BASS<F>" ↔
"BASS<Q>" ↔ "MID<G>" ↔ "MID<F>" ↔
"MID<Q>" ↔ "TREBLE<G>" ↔
"TREBLE<F>" ↔ "TREBLE<Q>"
* The factory default setting is "BASS G".
- 3-3. Press the [▲] or [▼] button to select the setting.

BASS<G>: The factory default setting is "0".
(Adjustment range: +7 to -7)

BASS<F>: The factory default setting is "50".
(Adjustment range: 50/100/200)

BASS<Q>: The factory default setting is "1".
(Adjustment range: 0.7/1/1.4/2)

MID<G> : The factory default setting is "0".
(Adjustment range: +7 to -7)

MID<F> : The factory default setting is "500".
(Adjustment range: 500/1K/2K)

MID<Q> : The factory default setting is "1".
(Adjustment range: 0.7/1/1.4/2)

TREBLE<G>: The factory default setting is "0".
(Adjustment range: +7 to -7)

TREBLE<F>: The factory default setting is "10K".
(Adjustment range: 5K/10K/15K)

TREBLE<Q>: The factory default setting is "1".
(Adjustment range: 0.7/1/1.4/2)

- 3-4. Press the [P/ENT] button to return to the previous mode.

● Setting the MAGNA BASS EXTEND

The MAGNA BASS EXTEND does not adjust the low frequencies like the normal sound adjustment function, but emphasizes the deep bass frequencies to provide you with a dynamic sound.

- * The factory default setting is "OFF" (off).

2-1. Select "M-B EX".

- 3-1. Press [▲] or [▼] button to select "ON" or "OFF".

● Adjusting the balance

2-1. Select "BALANCE".

- 3-1. Press the [▲] or [▼] button to adjust the balance of the right and left speakers.

- * The factory default setting is "CENTER" (center). (Adjustment range: RIGHT12 to LEFT12 (right 12 to left 12))

● Adjusting the fader

2-1. Select "FADER".

- 3-1. Press the [▲] or [▼] button to adjust the balance of the rear and front speakers.

- * The factory default setting is "CENTER" (center). (Adjustment range: FRONT12 to REAR12 (front 12 to rear 12))

● Setting the subwoofer

You can set the low pass filter of subwoofer.

2-1. Select "LPF".

- 3-1. Each time press the [▲] or [▼] button to select the setting, the setting changes in the following order:

"THROUGH" ↔ "60" ↔ "90" ↔ "120"

- * The factory default setting is "THROUGH".

● Adjusting the subwoofer output volume

You can adjust the volume output from the unit's subwoofer output terminal.

2-1. Select "**S-W VOL**".

3-1. Press the [**▲**] or [**▼**] button to increase or decrease the subwoofer volume.

- * The factory default setting is "**0**".
(Adjustment range: +6 to -6)

● Adjusting the high pass filter

2-1. Select "**HPF**".

3-1. Each time you press the [**▲**] or [**▼**] button to select the setting.

The setting changes in the following order:
"**THROUGH**" ↔ "**60**" ↔ "**90**" ↔ "**120**"

- * The factory default setting is "**THROUGH**" (through).

Setting the BBE MP (Sound Enhancement and Restoration for compressed audio files)

BBE MP (Minimized Polynomial Non-Linear Saturation) Process improves digitally compressed sound, such as MP3, by restoring and enhancing the harmonics lost through compression. BBE MP works by regenerating harmonics from the source material, effectively recovering warmth, detail and nuance.

* This function is effective for the audio files in the CD/MP3/WMA/AAC or USB/iPod mode, but it is ineffective for the video in the USB/iPod mode.

1. Press the [**SOUND**] button to switch to the sound adjustment selection display.
2. Press the [**◀◀**] or [**▶▶**] button to select "**BBE MP**".
3. Press the [**▲**] or [**▼**] button to select "**ON**" or "**OFF**".
 - * The factory default setting is "**OFF**".
4. When you select "**ON**", press the [**ENT**] button, then press the [**▲**] or [**▼**] button to select as following order.

LOW ↔ **MID** ↔ **HIGH**

Notes:

- Manufactured under license from BBE Sound, Inc.
- Licensed by BBE Sound, Inc. under one or more of the following US patents: 5510752, 5736897. BBE and BBE symbol are registered trademarks of BBE Sound, Inc.
- During **SOUND** adjustment mode, if no operation is performed for more than 10 seconds, this mode can be cancelled and return to previous mode.

Radio Operations

Listening to the radio

1. Press the [SRC] button and select the radio mode.
2. Press the [BND] button and select the radio band. Each time the button is pressed, the radio reception band changes in the following order:
FM1 → FM2 → FM3 → AM → FM1...

Tuning

There are 3 types of tuning mode available, seek tuning, manual tuning and preset tuning.

Seek tuning

1. Press the [BND] button and select the desired band (FM or AM).
 - * If "MANU" is lit in the display, press and hold the [BND] button (1 sec.). "MANU" in the display goes off and seek tuning is now available.
2. Press the [◀◀] or [▶▶] button to automatically seek a station.

Manual tuning

There are 2 ways available: Quick tuning and step tuning.

● Quick tuning

Press and hold the [◀◀] or [▶▶] button (1 sec.) to tune in a station.

● Step tuning

Press the [◀◀] or [▶▶] button to manually tune in a station.

Recalling a preset station

A total of 24 preset positions (6-FM1, 6-FM2, 6-FM3, 6-AM) exists to store individual radio stations in memory. Press the corresponding [DIRECT] button or the [▲] / [▼] button to recall the stored radio frequency automatically.

Manual memory

1. Select the desired station with seek tuning or manual tuning.
2. Press and hold one of the [DIRECT] buttons (2 sec.) to store the current station into preset memory.

Auto store

Auto store is a function for storing up to 6 stations that are automatically tuned in sequentially. If 6 receivable stations cannot be received, a previously stored station remains unoverwritten at the memory position.

1. Press the [BND] button and select the desired band (FM or AM).
2. Press and hold the [P/M ENT] button for 2 seconds or longer. The stations with good reception are stored automatically to the preset channels.

* If auto store is performed in the FM bands, the stations are stored in FM3 even if FM1 or FM2 was chosen for storing stations.

Preset scan

Preset scan receives the stations stored in preset memory in order. This function is useful when searching for a desired station in memory.

1. Press the [P/M ENT] button.
2. When a desired station is tuned in, press the [P/M ENT] button again to continue receiving that station.

Note:

- Be careful not to press and hold the [P/M ENT] button (2 sec.), otherwise the auto store function is engaged and the unit starts storing stations.

Instant station recall (ISR)

Instant station recall is a special radio preset that instantly accesses a favorite radio station at a touch of a button. The ISR function even operates with the unit in other modes.

● ISR memory

1. Select the station that you wish to store in ISR memory.
2. Press and hold the [ISR] button (2 sec.).

● Recalling a station with ISR

In any mode, press the [ISR] button to turn on the radio function and tune the selected radio station. "ISR" appears in the display. Press the [ISR] button again to return to the previous mode.

MP3/WMA/AAC

This unit can play back MP3/WMA/AAC files.

Notes:

- If you play a file with DRM (Digital Rights Management) for WMA remaining ON, no audio is output (The WMA indicator blinks).
- Windows Media™, and the Windows® logo are trademarks, or registered trademarks of Microsoft Corporation in the United States and/or other countries.

● To disable DRM (Digital Rights Management)

1. When using Windows Media Player 9/10/11, click on TOOL → OPTIONS → MUSIC RECORD tab, then under Recording settings, unclick the Check box for RECORD PROTECTED MUSIC. Then, reconstruct files.

Personally constructed WMA files are used at your own responsibility.

Precautions when creating MP3/WMA/AAC file

● Usable sampling rates and bit rates

1. MP3: Sampling rate 8 kHz-48 kHz,
Bit rate 8 kbps-320 kbps / VBR
2. WMA: Bit rate 8 kbps-320 kbps
3. AAC: Sampling rate 8 kHz-48 kHz,
Bit rate 8 kbps-320 kbps / VBR

● File extensions

1. Always add a file extension “.MP3”, “.WMA” or “.M4A” to MP3, WMA or AAC file by using single byte letters. If you add a file extension other than specified or forget to add the file extension, the file cannot be played.
2. Files without MP3/WMA/AAC data will not play. The files will be played soundlessly if you attempt to play files without MP3/WMA/AAC data.

* When VBR files are played, the play time display may differ the play location.

* When MP3/WMA/AAC files are played, a little no sound part is caused between tunes.

● Logical format (File system)

1. When writing MP3/WMA/AAC file on a CD-R disc or CD-RW disc, please select “ISO9660 level 1, 2 or JOLIET or Romeo” or APPLE ISO as the writing software format. Normal play may not be possible if the disc is recorded on another format.

2. The folder name and file name can be displayed as the title during MP3/WMA/AAC play but the title must be within 64 single byte alphabetical letters and numerals (including an extension).
3. Do not affix a name to a file inside a folder having the same name.

● Folder structure

1. A disc with a folder having more than 8 hierarchical levels will be impossible.

● Number of files or folders

1. Up to 255 files can be recognized per folder. Up to 510 files can be played.
2. Tracks are played in the order that they were recorded onto a disc. (Tracks might not always be played in the order displayed on the PC.)
3. Some noise may occur depending on the type of encoder software used while recording.

Set the type of file to be played (multi-session function)

When a single disc holds both normal CD type tracks and MP3/WMA/AAC type tracks, use this command to select which type of track to play.

* Default setting is “CD”.

- When only one type of track (either music CD or MP3/WMA/AAC) is recorded on a disc, selecting either type will allow playback of the disc.
- When playing CCCD (copy-control CDs), set to CD type.

1. Press and hold the [DISP] button for 1 second or longer.
2. Press the [◀◀] or [▶▶] button to select “M-SESS”.
3. Press the [▲] or [▼] button to select the “CD” or “MP3”.
 - “CD”
When playing music CD only.
 - “MP3”
When playing music MP3/WMA/AAC only.
4. When setting is completed, remove the disc and reinsert it.

CD/MP3/WMA/AAC Operations

Disc-In-Play function

As long as the ignition key is turned to the ON or ACC position, this function allows you to turn the power to the unit and start playing the disc automatically when the disc is inserted even if the power is not turned on.

⚠ CAUTION

- Do not try to put your hand or fingers in the disc insertion slot. Also never insert foreign objects into the slot.
- Do not insert discs where adhesive comes out from cellophane tape or a rental CD label, or discs with marks where cellophane tape or rental CD labels were removed. It may be impossible to extract these discs from the unit and they may cause the unit to break down.

Backup Eject function

Just pressing the [**▲**] button, ejects the disc even if the power to the unit was not turned on.

1. Press the [**OPEN**] button to open the FLIP DOWN PANEL.

Note:

- * If the FLIP DOWN PANEL will not open far enough, open it gently with your hand.
2. Press the [**EJECT**] button. Remove the disc after it is ejected.
 3. Close the FLIP DOWN PANEL.
 - * Press the center of the DCP to close.

Notes:

- Always close the FLIP DOWN PANEL once you take out the disc.
- If a CD (12 cm) is left in the ejected position for 15 seconds, the CD is automatically reloaded (Auto reload).
- If you force a CD into before auto reloading, this can damage the CD.

Listening to a disc already loaded in the unit

Press the [**SRC**] button to select the CD/MP3/WMA/AAC mode.



When the unit enters the CD/MP3/WMA/AAC mode, play starts automatically.

If there is no disc loaded, the indication “**NO DISC**” appears in the title display.

Loading a CD

1. Press the [**OPEN**] button to access the CD SLOT behind the FLIP DOWN PANEL.
2. Insert a CD into the center of the CD SLOT with the labeled side facing up. “**LOADING**” appears in the display, the CD enters into the slot, and the play starts.

Notes:

- Never insert foreign objects into the CD SLOT.
 - If the CD is not inserted easily, there may be another CD in the mechanism or the unit may require service.
 - Discs not bearing the  or  mark and CD-ROMs cannot be played by this unit.
 - Some CDs recorded in CD-R/CD-RW mode may not be usable.
3. Close the FLIP DOWN PANEL.
 - * Press the center of the DCP to close.

⚠ CAUTION

Be careful not to catch your hand or fingers while closing the FLIP DOWN PANEL.

Notes:

- * If the FLIP DOWN PANEL does not open fully, gently open with your hand.
- * After loading a CD, always close the FLIP DOWN PANEL.

Pausing play

1. Press the [**⏸**/**ENT**] button to pause play. “**PAUSE**” appears in the display.
2. To resume CD play, press the [**⏸**/**ENT**] button again.

Displaying CD titles

This unit can display title data for CD-text/MP3/WMA/AAC disc and user titles input with this unit.

1. Each time you press the [**DISP**] button to change the title display.

● CD-TEXT disc

User → Track → Disc/Artist → User ...

● MP3/WMA/AAC disc

Track → Folder → Title/Album → Artist → Track ...

Notes:

- If the CD playing is not a CD-text CD or no user title has been input, "NO TITLE" appears in the display.
- If MP3/WMA/AAC disc is not input TAG, "NO TITLE" appears in the display.
- For MP3, supports ID3 Tags V2.3 / 2.2 / 1.1 / 1.0.
- Tag displays give priority to V2.3 / 2.2.
- In the case of album Tags for WMA, the information written into the extension header is displayed.
- Only ASCII characters can be displayed in Tags.

Selecting a track

● Track-up

1. Press the [▶▶] button to move ahead to the beginning of the next track.
2. Each time you press the [▶▶] button, the track advances ahead to the beginning of the next track.

● Track-down

1. Press the [◀◀] button to move back to the beginning of the current track.
2. Press the [◀◀] button twice to move back to the beginning of the previous track.

Fast-forward/fast-reverse

● Fast-forward

1. Press and hold the [▶▶] button (1 sec.).

● Fast-reverse

1. Press and hold the [◀◀] button (1 sec.).

* For MP3/WMA/AAC discs, it takes some time until the start of searching and between tracks. In addition, the playing time may have a margin of error.

Folder Select

This function allows you to select a folder containing MP3/WMA/AAC files and start playing from the first track in the folder.

1. Press the [▼] or [▲] button.
Press the [▲] button to move the next folder. Press the [▼] button to move the previous folder.
2. To select a track, press the [◀◀] or [▶▶] button.

Top function

The top function resets the CD player to the first track of the disc. Press the [BND] button to play the first track (track No. 1) on the disc.

* In case of MP3/WMA/AAC, the first track of a folder being played will be returned.

List search function

1. Press and hold the [BND] button (1 sec.) to enter the list search mode. And then the track list appears in the display.
2. Press the [▼] or [▲] button to select a track.
* If you press the [◀◀] or [▶▶] button, the track list scroll 5 lines at a time.
3. Press the [▶/■] button to play.
* In case of MP3/WMA/AAC, this function is performed in the current folder.

Note:

- If no operation is performed for more than 10 seconds, this mode can be cancel and return to the usual mode.

Other various play functions

● Scan play

This function allows you to locate and play the first 10 seconds of all the tracks recorded on a disc.

1. Press the [SCN] button to perform scan play.

● Folder scan play

This function allows you to locate and play the first 10 seconds of the first track of all the folders on an MP3/WMA/AAC disc.

1. Press and hold the [SCN] button (1 sec.) to perform folder scan play.

● Repeat play

This function allows you to play the current track repeatedly.

1. Press the [RPT] button to perform repeat play.

● Folder repeat play

This function allows you to play a track currently being played in the MP3/WMA/AAC folder repeatedly.

1. Press and hold the [RPT] button (1 sec.) to perform folder repeat play.

CD/MP3/WMA/AAC Operations

● Random play

This function allows you to play all tracks recorded on a disc in a random order.

1. Press the [RDM] button to perform random play.

● Folder random play

This function allows you to play all the tracks of all the folders recorded on an MP3/WMA/AAC disc in a random order.

1. Press and hold the [RDM] button (1 sec.) to perform folder random play.

● To cancel play

1. Press the operating button previously selected.
 - * The various play mode is canceled and the various play off mode appears in the display for 2 seconds.

Bluetooth Operations

The Bluetooth allows you to utilize your car's built-in audio system for wireless mobile phone or music handsfree communication.

Some Bluetooth mobile phones have the audio features, and some portable audio players support Bluetooth feature.

This system can play audio data stored in a Bluetooth audio device.

The car stereo with Bluetooth will be able to retrieve phonebook contacts, received call, dialed call, missed call, incoming calls, outgoing call, redial call and listen to music.

Notes:

- *Do not leave the microphone of Bluetooth handsfree in the places with wind passing such as air outlet of the air conditioner, etc. This may cause a malfunction. In addition, if leave it in the places subjected to direct sun, high temperature can cause distortion, discoloration which may result in a malfunction.*
- *This system will not operate or may operate improperly with some Bluetooth audio players.*
- *For detailed information on the playable Bluetooth audio players, see our home page: www.clarion.com*
- *When a audio device is paired, the following operations are the same as for CD mode:*

* **Pause**

* **Track selection**

* **Fast-forward**

* **Fast-reverse**

The titles and the play time can not appear in the display.

See "CD/MP3/WMA/AAC Operations" (page 15) for details.

Basic Operations

Select Bluetooth

1. Press the [SRC] button to switch the source.
2. You can press and hold the [SOUND] button to disconnect the currently connected device.

Switch the display

Press the [DISP] button to select the display in the following order:

"BT TEL" → "BT AUDIO"

- * The connected device name will appear in the display.

Making a call

There are 4 ways to make outgoing call.

● Direct Number Call

Outgoing call can be made by entering telephone numbers directly via the car stereo. Telephone number uses 0, 1, 2, 3, 4, 5, 6, 7, 8, 9, *, #, and +.

1. Press the [BND] button to select "DIAL NUMBER".
2. Press the [$\frac{P}{ENT}$] button.
3. Press the [\blacktriangle] or [\blacktriangledown] button to select the numbers.
4. Press the [◀◀] or [▶▶] button to input or delete the number.
5. Press and hold the [$\frac{P}{ENT}$] button (1 sec.) to call the mobile phone No.
 - * Press the [SOUND] button to end the call.

● Call from Phonebook

User can search the contact name in the phonebook and make call.

Alternatively, user can call from mobile phone.

1. Press the [BND] button to select "PHONE BOOK".
2. Press the [▶▶] button to enter the contact name mode (In this case, use the [\blacktriangle], [\blacktriangledown] button to select the desired contact name).
3. When the contact name is displayed, press the [▶▶] or [◀◀] button to select the contact name's phone number.
4. Press the [$\frac{P}{ENT}$] button to call the mobile phone No.
 - * Press the [SOUND] button to end the call.

● Answering a call

1. You can answer an incoming call by pressing any button.
 - * Press the [SOUND] button to reject an incoming call.

● Received/Dialed/Missed Call History

You can search any Received/Dialed/Missed Call History.

1. Press the [BND] button to select "HISTORY".
2. Press the [▶▶] button to enter the contact name mode (In this case, use the [\blacktriangle], [\blacktriangledown] button to select the desired contact name).
3. When the contact name is displayed, press the [◀◀] or [▶▶] button to select the contact name's phone number.
4. Press the [$\frac{P}{ENT}$] button to call the mobile phone No.

Bluetooth Operations

● Redial a call

You can call a redial phone No.

1. Press the [BND] button to select “REDIAL”.
2. Press and hold the [$\frac{P}{ENT}$] button (1 sec.) to call the redial phone No.
 - * Press the [SOUND] button to end the call.

To change Bluetooth adjustment setting

1. Press and hold the [DISP] button (1 sec.) to switch to the Bluetooth adjustment selection display.
2. Press the [◀◀] or [▶▶] button to select the “item name”.

“PAIRING” ↔ “SELECT” ↔ “DELETE” ↔ “DISCONNECT” ↔ “ADD PHONE BOOK” ↔ “DEL NO. PHONE BOOK” ↔ “HISTORY DELETE ALL” ↔ “PHONE BOOK TYPE” ↔ “MIC GAIN” ↔ “RING VOL” ↔ “TONE SEL” ↔ “NOISE” ↔ “AUTO ANS” ↔ “AUTO CON” ↔ “PASS KEY” ↔ “ADDRESS” ↔ “BT NAME” ↔ “BT FW”
3. Press the [▲] or [▼] button to select the “desired setting value”.
 - * In the case of display blinking “ENT”, you can press the [$\frac{P}{ENT}$] button to adjust the setting value.
 - * After completing settings, press the [DISP] button to return to the previous mode.

● PAIRING

This option is used to perform Bluetooth pairing with the mobile phone and audio.

Up to a maximum of 5 mobile phones and a audio device can be paired.

- 2-1. Select “PAIRING”.
- 3-1. Press the [$\frac{P}{ENT}$] button.
- 3-2. Press the [▲] or [▼] button to select “TELEPHONE” or “AUDIO”, then press the [$\frac{P}{ENT}$] button.

For a no paired device after reset or at the same time, when you select “TELEPHONE”, please press the [▲] or [▼] button to select the phone book type.

(For details, see the chapter “PHONE BOOK TYPE” (page 21))

- 3-3. After select the “TELEPHONE”, press the [▲] or [▼] button to select “MEMORY 1” to “MEMORY 5”, then press and hold the [$\frac{P}{ENT}$] button (1 sec.) to memory.

- 4-1. Press the [▲] or [▼] button to select “SEARCH” or “WAIT”.

- 5-1. Press and hold the [$\frac{P}{ENT}$] button (1 sec.).
 - * When the “SEARCHING” appears in the display, you can press the [$\frac{P}{ENT}$] button to stop search, then the list search appear.

“SEARCH” mode: User can search the Bluetooth mobile phone or audio device.

“WAIT” mode: User can search this unit via the mobile phone or audio device.

- 6-1. After the search, press the [▲] or [▼] button to select the desired Bluetooth mobile phone.
- 7-1. Press and hold the [$\frac{P}{ENT}$] button (1 sec.) to pair.

● SELECT

This is a setting for user to select one of the paired mobile phones or audio.

- 2-1. Select “SELECT”.
- 3-1. Press the [$\frac{P}{ENT}$] button, then the paired mobile phones appears in the display.
- 4-1. Press the [▲] or [▼] button to choose one of the 5 mobile phones.
- 5-1. Press and hold the [$\frac{P}{ENT}$] button (1 sec.) to connect.

Connected device will be able to use all the functionalities provided.

● DELETE

This is a setting for user to delete one of the paired device from the list.

- 2-1. Select “DELETE”.
- 3-1. Press the [$\frac{P}{ENT}$] button, then the paired mobile phones appears in the display.
- 4-1. Press the [▲] or [▼] button to choose one of the 5 phones and a audio devices.
- 5-1. Press and hold the [$\frac{P}{ENT}$] button (1 sec.) to delete the paired device.

Notes:

- After deleting the device, the phone book and the call history records will be deleted too.
- Deleted paired device will not automatically rearrange in the paired device list.

● DISCONNECT

This option is used to disconnect the currently connected device.

- 2-1. Select “DISCONNECT”.
- 3-1. Press and hold the [$\frac{P}{ENT}$] button (1 sec.) to disconnect.
 - * Press and hold the [SOUND] button (2 sec.) to disconnect.

Bluetooth Operations

● ADD PHONE BOOK

This option is used to add one of the phone No.

- 2-1. Select **"ADD PHONE BOOK"**.
- 3-1. Press the [**ENT**] button (1 sec.), then the **"RECEIVING"** appears in the display.
 - * At the same time the phone No. from the paired phone book list is sent out, then there is a prompt on the mobile phone if it is successful.
 - * Some mobile phones cannot transfer the phone book to this unit because of the less word and the language type. In this time, please edit your phone book in other language, and transfer it once again.

● DEL NO. PHONE BOOK

This option is used to delete one of or all phone No. of the added phone book.

- 2-1. Select **"DEL NO. PHONE BOOK"**.
- 3-1. Press the [**ENT**] button.
- 4-1. Press the [**▲**] or [**▼**] button to select **"1 DEL"** or **"ALL DEL"**.
- 5-1. When you select **"1 DEL"**, press the [**ENT**] button, then press the [**▲**] or [**▼**] button to select one of the desired phone No.
- 6-1. Press the [**ENT**] button, then the **"DELETE?"** appears in the display.
- 7-1. Press the [**ENT**] button (1 sec.) to delete.

Note:

- If you want to transfer or handl this unit, please perform **"DELETE"**, **"ADD PHONE BOOK"** and **"DEL NO. PHONE BOOK"** function to delete all of your personal information.

● HISTORY DELETE ALL

This option is used to delete all of the call records.

- 2-1. Select **"HISTORY DELETE ALL"**.
- 3-1. Press the [**ENT**] button, then the **"CONFIRM?"** appears in the display.
- 4-1. Press the [**ENT**] button (1 sec.), then the **"DELETING"** appears in the display, delete all of the call records successfully.

● PHONE BOOK TYPE

The unit provide 3 types of phone book which are stored in memory.

- 2-1. Select **"PHONE BOOK TYPE"**.
- 3-1. Press the [**ENT**] button.
- 3-2. Press the [**▲**] or [**▼**] button to select **"1"**, **"2"** or **"3"**, then press the [**ENT**] button to store in memory.

Notes:

- If you change the phone book type, all of the paired mobile phones's book data will be deleted.
- The piece number of the phone book's record can be stored in the different memory of the phone book type are as follow:

PHONE TYPE	MEMORY 1	MEMORY 2	MEMORY 3	MEMORY 4	MEMORY 5
1	250 piece	250 piece	0 piece	0 piece	0 piece
2	200 piece	100 piece	100 piece	50 piece	50 piece
3	100 piece	100 piece	100 piece	100 piece	100 piece

● MIC GAIN

MIC gain can be set by each paired mobile phone device. Each registered device has unique MIC gain setting.

- 2-1. Select **"MIC GAIN"**.
- 3-1. Press the [**▲**] or [**▼**] button to change the MIC gain setting.
 - * The factory default setting is **"3"**. (Adjustment range: 1 to 5)

● RING VOL

This option is used to change the ringing volume by each paired mobile phone device.

- 2-1. Select **"RING VOL"**.
- 3-1. Press the [**▲**] or [**▼**] button to change the ringing volume.
 - * The factory default setting is **"5"**. (Adjustment range: 1 to 10)

● TONE SEL

The system can ring if the mobile phone cannot ring when the Bluetooth connection has been established.

- 2-1. Press **"TONE SEL"**.
- 3-1. Press the [**▲**] or [**▼**] button to select **"INTERNAL"** or **"AUTO"**.
 - * The unit setting is **"AUTO"**. **"INTERNAL"**: Adjust tone in the car bluetooth system. **"AUTO"**: Automatic adjustment is enabled in the paired mobile phone.

● NOISE

This option is used to set noise volume in the car bluetooth system.

- 2-1. Press **"NOISE"**.
- 3-1. Press the [**▲**] or [**▼**] button to select **"LOW"** or **"HIGH"**.
 - * The factory default setting is **"LOW"**.

Bluetooth Operations

● AUTO ANS

This is a setting to determine whether any incoming call will be automatically or manually answered.

* The factory default setting is "OFF".

2-1. Select "AUTO ANS".

3-1. Press the [**▲**] or [**▼**] button to select "ON" or "OFF".

ON: Any incoming call is automatically answered in 5 seconds.

OFF: User needs to manually answer the call.

● AUTO CONNECT

This function allows the Bluetooth to be connected automatically with previously connected device. Connection can be established at any source mode.

* The factory default setting is "OFF".

2-1. Select "AUTO CON".

3-1. Press the [**▲**] or [**▼**] button to select "ON" or "OFF".

ON: Automatic connection is enabled.

OFF: Automatic connection is disabled.

● PASS KEY

This PASS KEY is used during pairing mode. A maximum of 10 digits can be changed through the car stereo.

* The factory default PASS KEY is "1234".

2-1. Select "PASS KEY".

3-1. Press the [**ENT**] button.

4-1. Press the [**◀◀**] or [**▶▶**] button to remove the cursor.

5-1. Press the [**▲**] or [**▼**] button to select the desired digits.

6-1. Press and hold the [**ENT**] button (2 sec.) to store in memory.

* If press the [**BND**] button, the pass key returns to the factory default setting.

● ADDRESS

This will hold the unique Bluetooth address. The address is 12 figures.

2-1. Select "ADDRESS".

The Bluetooth address 6 figures appears in the display.

3-1. Press the [**▲**] or [**▼**] button to display.

● Bluetooth Name

This will display the name of the Bluetooth.

2-1. Select "BT NAME".

The Bluetooth name appears in the display.

● Bluetooth Firmware version

This will display the Firmware version of the Bluetooth.

2-1. Select "BT FW".

The Bluetooth Firmware version appears in the display.

To change adjustment setting

1. Press and hold the [DISP] button (1 sec.) to switch to the adjustment selection display.
2. Press the [◀◀] or [▶▶] button to select the "item name".
 "CLOCK" ↔ "CONTRAST" ↔
 "SETTINGS" ↔ "SCRN SVR" ↔
 "MESSAGE INPUT" ↔ "SCROLL" ↔
 "DIMMER" ↔ "BLINKLED" ↔
 "A-CANCEL" ↔ "SYSTEM CHECK"
3. Press the [▲] or [▼] button to select the "desired setting value".
 * In the case of display blinking "ENT", you can press the [ENT] button to adjust the setting value.
 * After completing settings, press the [DISP] button to return to the previous mode.

● Setting the clock

- 2-1. Select "CLOCK".
- 3-1. Press the [ENT] button.
- 3-2. Press the [◀◀] or [▶▶] button to select the hour or the minute.
- 3-3. Press the [▲] or [▼] button to set the correct time.
 * The clock is displayed in 12-hour format.
- 3-4. Press the [ENT] button to store the time into memory.

Note:

- You cannot set the clock when it is displayed with only the ignition on. If you drain or remove the car's battery or take out this unit, the clock is reset. While setting the clock, if another button or operation is selected, the clock set mode is canceled.

● Setting the contrast

You can adjust the display contrast to match the angle of installation of the unit.

- * The factory default setting is "10".

(Adjustment level: 1 to 16)

- 2-1. Select "CONTRAST".
- 3-1. Press the [▲] or [▼] button to adjust the contrast.

● Displaying the settings

The number of indicator of this unit decreases, you can see the state of current settings at any operation mode.

- 2-1. Select "SETTINGS".
- 3-1. Press the [▲] or [▼] button to display the state of current settings.
 * When the setting is selected, after 1 second the current state will be displayed.

For example: after 1 second,

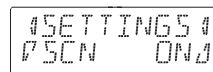
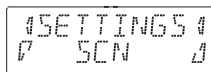

● Turning the screen saver function on or off

This unit is provided with the screen saver function which allows you to show various kinds of patterns and characters in the operation status indication area of the display in a random order. You can turn on or off this function. If the button operation is performed with the screen saver function on, the operation display corresponding to the button operation is shown for about 30 seconds and the display returns to the screen saver display.

- * The factory default setting is "ON".

- 2-1. Select "SCRN SVR".
- 3-1. Press the [▲] or [▼] button to select the setting.
 Each time you press the [▲] or [▼] button, the setting changes in the following order:

"MESSAGE" ↔ "OFF" ↔ "ON"

● Entering message information

Message up to 30 characters long can be stored in memory and displayed as a type of screen saver setting.

- * The factory default setting is "WELCOME TO CLARION".

- 2-1. Select "MESSAGE INPUT".
- 3-1. Press the [ENT] button.
- 3-2. Press and hold the [BND] button (1 sec.) to clear the old message.
- 3-3. Press the [◀◀] or [▶▶] button to move the cursor.

Operations Common to Each Mode

3-4. Press the [BND] button to select a character type. Each time you press the [BND] button, the character type changes in the following order:

Capital letters → Numbers → Symbols → Capital letters...

3-5. Press the [▲] or [▼] button to select the desired character.

3-6. Repeat step 3-3 to 3-5 to enter up to 30 characters for message.

3-7. Press and hold the [ENT] button (2 sec.) to store the message in memory.

* Press and hold the [BND] button (1 sec.) to cancel the input message. Then press and hold the [ENT] button (2 sec.) to store the message and the message return to default setting.

● Setting the method for title scroll

Set how to scroll in CD-TEXT, MP3/WMA/AAC title.

* The factory default setting is "ON".

2-1. Select "SCROLL".

3-1. Press the [▲] or [▼] button to select "ON" or "OFF".

• **ON:**

To scroll automatically.

• **OFF:**

To scroll just 1 time.

* When you want to see the title again, in the title mode, press and hold the [DISP] button for 3 seconds or longer to scroll the title.

● Setting the dimmer control

You can set the dimmer control "ON" or "OFF".

* The factory default setting is "ON".

2-1. Select "DIMMER".

3-1. Press the [▲] or [▼] button to select "ON" or "OFF".

● Anti-theft indicator

The red Anti-theft indicator is a function for preventing theft. When the ACC is off, this indicator blinks.

* The factory default setting is "OFF".

2-1. Select "BLINKLED".

3-1. Press the [▲] or [▼] button to select "ON" or "OFF".

● Setting the external amplifier

* The factory default setting is "OFF".

2-1. Select "A-CANCEL".

3-1. Press the [▲] or [▼] button to select "ON" or "OFF".

• **ON:**

Use with connected AMP.

• **OFF:**

Use with inside AMP.

● Performing a system check

This function allows you to perform a system check from the adjust mode when required.

2-1. Select "SYSTEM CHECK".

3-1. Press and hold the [ENT] button (1 sec.).

"SYSTEM CHECK" appears in the display, then the unit returns to the previous operation mode.

Entering titles

Titles up to 10 characters long can be stored in memory and displayed for CD, CD changer, Radio stations. The number of titles that can be entered for each mode are as follows.

Mode	Number of titles
CD mode	50 titles
Radio mode	30 titles

CD changer mode	Number of titles
DCZ625 connected	100 titles

1. Press the [SRC] button to select the mode you want to enter a title (Radio, CD).
2. Select and play a CD or Radio for which you want to enter the title.
3. Press and hold the [DISP] button (1 sec.).
4. Press the [◀◀] or [▶▶] button to select "TITLE INPUT".
5. Press the [ENT] button.
The display switches to the title input display.
6. Press the [◀◀] or [▶▶] button to move the cursor.
7. Press the [BND] button to select a character type. Each time you press the [BND] button, the character type changes in the following order:
Capital letters → Numbers → Symbols → Capital letters...

Operations Common to Each Mode

8. Press the [**▲**] or [**▼**] button to select the desired character.
9. Repeat steps 6 to 8 to enter up to 10 characters for the title.
10. Press and hold the [**▶/■**]_{ENT} button (2 sec.) to store the title into memory.

Clearing titles

1. Select and play a CD or tune in Radio for which you want to clear the title.
2. Press and hold the [**DISP**] button (1 sec.).
3. Press the [**◀◀**] or [**▶▶**] button to select **"TITLE INPUT"**.
4. Press the [**▶/■**]_{ENT} button.
The display switches to the title input display.
5. Press and hold the [**BND**] button (1 sec.).
All characters in the title disappear.
6. Press and hold the [**▶/■**]_{ENT} button (2 sec.) to store the setting.

AUX function

This system has an external input jack on the front panel so you can listen to sounds and music from external devices connected to this unit.

● Selecting AUX IN sensitivity

Make the following settings to select the sensitivity when sounds from external devices connected to this unit are difficult to hear even after adjusting the volume.

* The factory default setting is **"MID"**.

1. Press and hold the [**DISP**] button (1 sec.).
2. Select **"AUX SENS"**.
3. Press the [**▲**] or [**▼**] button to select **"HIGH"**, **"MID"** or **"LOW"**.

Note:

- When AUX mode is selected, AUX IN sensitivity can be set.

7. ACCESSORIES

USB/MTP Operations

USB memory/MTP device operation

Note:

- The following operations are the same as for CD mode:
 - *Pause
 - *Track selection
 - *Fast-forward/fast-backward (Except DRM file)
 - *Top function
 - *List search
 - *Scan play
 - *Repeat play
 - *Random play
 - *Folder selection

See “CD/MP3/WMA/AAC Operations” (page 15-18) for details.

About USB memory

- USB is an acronym for Universal Serial Bus, and refers to an external bus standard supporting data transfer rates of 12 Mbps.
- This unit is compatible with USB 1.1/2.0 with maximum data transfer rates of 12 Mbps.
- USB memory devices that can be played by connecting to the unit’s USB cable are limited to those recognized as “USB mass storage class devices”; operation is not guaranteed with all USB memory devices.
 - * Devices compatible with “USB Mass Storage Class” can be used merely by connecting to the host device, without need for special drivers or application software.
- Consult the manufacturer of your USB memory device for information regarding whether it is supported by “USB Mass Storage Class” standards.
- Audio files playable on this unit are limited to MP3/WMA/AAC files. For details, see the section “MP3/WMA/AAC” (page 15). Copy-protected WMA/AAC files cannot be played on this unit.
- The Podcast files of iTunes Store that stored in the USB memory device can not be played. Besides, the data that edit through some softs such as the Tag edit soft may not be played.
- To prevent the accidental loss of data, always back up important data on your computer.
- This unit does not support connections to a computer. In addition, connections made

through a USB hub device are also not supported.

- When a USB memory device is composed of two or more drives, only one of the drives will be detected.
- USB memory devices with security functions cannot be played.
- The order in which tracks are recorded may differ depending on the USB memory device connected (the actual playback order may not be the same as that indicated on your computer’s display).
- If you continuously operate folder up/down, the play time keeps as “00:00”, and the sound is not emitted.

About USB Digital Media Streaming

This unit supports USB Digital Media Streaming. USB Digital Media Streaming is a function used to play music files transmitted using Media Transfer Protocol (MTP). This function also supports the playback of WMDRM 10 files.

During USB Digital Media Streaming, the unit displays the “MTP” mode.

Use of USB Digital Media Streaming requires the purchase of a supported portable audio player. For information regarding supported portable audio players, consult your nearest Clarion dealer, or visit Clarion’s website.

CAUTION

- **Insert and remove a USB memory/MTP device only when the device is not being accessed. Connecting or disconnecting the device at the following times may result in the loss of data:**
 - If the USB memory/MTP device is removed or power is disconnected during writing to the device.
 - When the device is subjected to static electricity or electric noise.
- **Do not leave a USB memory/MTP device unattended in an automobile. Exposure to direct sunlight or high temperatures may cause deformation or other malfunction of the USB memory/MTP device.**

- Do not turn on vehicle ignition when the MTP device is connected, since it may result in loss or damage to data on the MTP device. Connect the MTP device to the USB cable after vehicle ignition is turned on.

Connecting a USB memory/MTP device

1. Connect the USB memory/MTP device to the USB cable.

Playback will begin from the first file recorded on the device.

- * If the device is not recognized, press the [SRC] button to switch the source to the device.
- * Always insert the device fully into the connector. Incomplete connections may cause the device not to be recognized.
- * Depending on the number of tracks recorded, some amount of time may be required until all tracks are read into the unit.
- * The order in which tracks are recorded may differ depending on the device connected (the actual playback order may not be the same as that indicated on your computer's display).

To listen to tracks on a connected USB memory/MTP device

1. Press the [SRC] button to switch the source. When USB memory/MTP device is selected, playback (except DRM files) will begin from the location at which playback was previously stopped.
 - * When a USB memory/MTP device is connected the USB/MTP mode will be displayed.
 - * When a USB memory/MTP device is disconnected and then reconnected, playback will begin from the beginning of the USB memory/MTP device.
 - * When "MTP" mode is selected, AAC files on the MTP device cannot be played.

To stop play

1. Press the [SRC] button and switch the function to a source other than the USB memory.

CAUTION

Do not remove the USB memory/MTP device when the USB/MTP mode is selected, since it may result in loss or damage to data on the USB memory/MTP device.

Always backup and save important data on your computer.

2. Remove the USB memory/MTP device from the USB cable.

iPod Operations

This section describes operations when connected to an Apple iPod via the USB cable.

Notes:

- See the *iPod Owner's Manual* for details regarding operation conditions.
- The unit will not operate, or may operate improperly with unsupported versions.
- For a list of compatible Apple iPod unit with the this model, please contact your Clarion dealer or www.clarion.com.
- "Made for iPod" means that an electronic accessory has been designed to connect specifically to iPod and has been certified by the developer to meet Apple performance standards.
Apple is not responsible for the operation of this device or its compliance with safety and regulatory standards.
iPod and iTunes are trademarks of Apple Inc., registered in the U.S. and other countries.

Connecting an iPod

When an iPod is connected to the USB slot, "Shuffle" set on the iPod will become as follows:

- "Shuffle (Albums)" play → Random play
- "Shuffle (Songs)" play → All random play

The iPod has two modes, the "Play mode" and the "iPod menu mode" for selecting tracks. Switch between these modes by pressing the [BND] button (1 sec.).

Note:

- To connect iPod, please use the USB cable attached in iPod.

Select iPod mode

1. Press the [SRC] button.

Playback will begin from the last file that was played on the iPod.

Notes:

- The following operations in Play mode operate the same as in CD mode:
 - *Track selection: [◀◀], [▶▶]
 - *Fast-forward/fast-reverse: [◀◀], [▶▶]
 - *Pause: [⏸_{ENT}]
 See "CD/MP3/WMA/AAC Operations" (page 15-18) for details.
- After a Podcast file has completed playback, the pause display, or the track-end position Play-Time display will appear. At that time, select a music file once again.

Setting iPod simple mode

Use this function if you wish to operate through your iPod connected to this unit via the USB cable.

* The factory default setting is "OFF".

1. Press and hold the [DISP] button (1 sec.).
2. Press [◀◀] or [▶▶] to select "S-CTRL".
3. Press the [⏸_{ENT}] button.
4. Press the [▲] or [▼] button to select "ON" or "OFF".
 - **ON:** Operations can be made through your iPod.
 - **OFF:** Operations cannot be made through your iPod.
5. Press and hold the [⏸_{ENT}] button (1 sec.) to store the setting and return to the previous mode.

Notes:

- When performing iPod operations using simple control mode, make the operations slowly. If repetitive operations are performed too quickly, unforeseen errors may occur.
- When performing iPod operations using simple control mode, please do not operate the iPod and the unit at the same time, otherwise there may be unexpected event happened.
- Some iPod models do not support this function. Consult your nearest Clarion dealer or website to confirm which models do not support this function.

Other various play functions (in Play mode)

Notes:

- These functions are not supported when in the iPod menu mode.
- The Repeat function set on the iPod remains the same after attachment/detachment of the iPod.
- The Repeat function on the iPod will be changed when you connect/disconnect the iPod to the unit.

● Repeat play

Play back one track repeatedly.

1. Press the [RPT] button.

● Random play

Play all albums within a selected category, in random order. (Corresponds to "Shuffle (Albums)" command on iPod.)

1. Press the [RDM] button.

iPod Operations

● All random play

Play all tracks within a selected category, in random order. (Corresponds to “Shuffle (Songs)” command on iPod.)

1. Press and hold the [RDM] button (1 sec.).

● To cancel play

1. Press the same play button once again.

Notes:

- When the repeat play mode is canceled, after play all tracks within a selected category, playback will begin from the first track in the selected category.
- When playing the last track within a selected category in Random mode, if ACC is switched off then on again, playback will begin from a different track.
- Though the default setting of an iPod is “All Repeat”, the indication on the mode status is not displayed.
- When performing operations using simple control mode, do not set the repeat off on the iPod.

Selecting category from the iPod menu

1. Press the [BND] button (1 sec.) to select the iPod menu mode.

The iPod menu categories will be displayed.

Notes:

- Repeat and Random mode operations are not supported when in the iPod menu mode.
 - In iPod menu mode, if you press the [◀◀]/[▶▶] or [▲]/[▼] button fast, playback may not be performed.
2. Press the [▲] or [▼] button to switch between categories.

The iPod menu categories alternate in the following order:

“PLAYLISTS” ↔ “ARTISTS” ↔ “ALBUMS”
 ↔ “SONGS” ↔ “GENRES” ↔
 “COMPOSERS”...

Note:

The iPod menu mode can be canceled by performing one of the following operations:

- Press the [BND] button.
 - When the category select screen is displayed, press the [▶▶] button.
3. Press the [▶▶] button to select the category.
 4. When the track name display is showing, press the [▶▶] button.

Playback will begin from the first track in the selected category, and the iPod menu mode will be canceled.

- * Subfolders may be displayed, depending on the category.
- In this case, use the [▲] and [▼] buttons to switch between subfolders, then use the [▶▶] button to select the desired subfolder.
- * When the track name display is showing, pressing the [◀◀] button will return to the currently playing folder name display.
5. Use the [▲] and [▼] buttons to select a track within a category.

iPod menu alphabet search

This function searches the subfolders for desired alphabetical letters.

1. Press the [BND] button to select the iPod menu mode.
 2. Press the [▲] or [▼] button to switch between categories.
 3. Press the [▶▶] button.
- * Subfolders may be displayed, depending on the category. In this case, you can use the [▲] or [▼] button to switch between subfolders and use the [▶▶] button to enter the next subfolder layer.
4. Press and hold the [DISP] button (1 sec.).
 5. Press the [▲] or [▼] button to select the desired letter to search.
 6. Press the [DISP] button to perform search.
- * During search, press the [DISP] button to cancel search.

Selecting category using preset memory

1. Press and hold the [BND] button (1 sec.) to select the iPod menu mode.

The category can be set as follows in the [DIRECT] (1-6) buttons.

[1] : PLAYLISTS

[2] : ARTISTS

[3] : ALBUMS

[4] : SONGS

[5] : GENRES

[6] : COMPOSERS

2. Press the desired [DIRECT] (1-6) button to select the category.
- * Subfolders may be displayed, depending on the category.

iPod Operations

In this case, use the [**▲**] and [**▼**] buttons to switch between subfolders, then use the [**▶▶**] button to select the desired subfolder.

3. When the track name display is showing, press the [**▶▶**] button.

Playback will begin from the first track in the selected category, and the iPod menu mode will be canceled.

* Use the [**▲**] and [**▼**] buttons to select a track within a category.

iPod menu list back

In the iPod menu operation mode:

If press the [**BND**] button, it will return to the previous subfolder list mode.

If press and hold the [**BND**] button (1 sec.), it will return to the category list mode.

About title display

This unit supports the display of title information transmitted from a connected iPod.

- Character code information is UTF-8; displayable characters include English alphanumerics, some symbols, and some umlaut characters.
- Unsupported characters will be replaced by asterisks (*).

8. TROUBLESHOOTING

	Problem	Cause	Measure
General	Power does not turn on. (No sound is produced.)	Fuse is blown.	Replace with a fuse of the same amperage. If the fuse blows again, consult your store of purchase.
		Incorrect wiring.	Consult your store of purchase.
	No sound output when operating the unit with amplifiers or power antenna attached.	Power antenna lead is shorted to ground or excessive current is required for remote-on the amplifiers or power antenna.	<ol style="list-style-type: none"> 1. Turn the unit off. 2. Remove all wires attached to the power antenna lead. Check each wire for a possible short to ground using an ohm meter. 3. Turn the unit back on. 4. Reconnect each amplifier remote wire to the power antenna lead one by one. If the amplifiers turn off before all wires are attached, use an external relay to provide remote-on voltage (excessive current required).
	Nothing happens when buttons are pressed.	The microprocessor has malfunctioned due to noise, etc.	Turn off the power, then press the [OPEN] button and remove the DCP. Press the reset button for about 2 seconds with a thin rod. If the RESET button is pressed when a disc is loaded, please eject the disc and load it once again before attempting to play it.
	Display is not accurate.		
		DCP or main unit connectors are dirty.	Wipe the dirt off with a soft cloth moistened with cleaning alcohol.
	No sound heard	The speaker protection circuit is operating.	<ol style="list-style-type: none"> 1. Turn down sound volume. Function can also be restored by turning the power off and on again. (Speaker volume is reduced automatically when the speaker protection circuit operates). 2. If the sound is muted again, consult our service department.

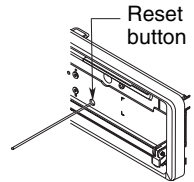

	Problem	Cause	Measure
CD/MP3/WMA/AAC	No sound heard	MP3/WMA/AAC files are absent in a disc.	Write MP3/WMA/AAC files onto the disc properly.
		Files are not recognized as an MP3/WMA/AAC file.	Use MP3/WMA/AAC files encoded properly.
		File system is not correct.	Use ISO9660 level 1, 2 or JOLIET or Romeo or APPLE ISO file system.
	Sound skips or is noisy.	Compact disc is dirty.	Clean the compact disc with a soft cloth.
		Compact disc is heavily scratched or warped.	Replace with a compact disc with no scratches.
	Sound is cut or skipped. Noise is generated or noise is mixed with sound.	MP3/WMA/AAC files are not encoded properly.	Use MP3/WMA/AAC files encoded properly.
	Sound is bad directly after power is turned on.	Water droplets may form on the internal lens when the car is parked in a humid place.	Let dry for about 1 hour with the power on.
Wrong filename	File system is not correct.	Use ISO9660 level 1, 2 or JOLIET or Romeo or APPLE ISO file system.	
USB/MTP/iPod	No sound heard	The device contains no MP3/WMA/AAC files.	Record MP3/WMA/AAC files properly to the device.
		The files are not proper MP3/WMA/AAC format.	Use only properly encoded MP3/WMA/AAC files.
		Connectors are loose.	Disconnect the device and reconnect securely.
		Some USB portable music players may consume current that exceeds the USB rating. In this case, this unit's overcurrent protection circuit operates to stop the music playback.	Check operation of portable music player.
	Sound is interrupted or has noise.	The MP3/WMA/AAC files are improperly encoded.	Use only properly encoded MP3/WMA/AAC files.
	The device isn't recognized.	The device is damaged.	Disconnect the device and reconnect. If the device is still not recognized, try replacing with a different device.
		Connectors are loose.	
		According to the state of operation on the device, the communication fault is caused.	Disconnect the device and reconnect.
Can't insert the device.	The device has been inserted improperly.	Try reversing the connection direction of the device (usually the brand name surface should be facing left).	
	The connector is broken.	Replace with a new device.	

9. ERROR DISPLAYS

If an error occurs, one of the following displays is displayed.

Take the measures described below to eliminate the problem.

	Error Display	Cause	Measure
CD/MP3/WMA/AAC	ERROR 2	A CD is caught inside the CD deck and is not ejected.	This is a failure of CD deck's mechanism and consult your store of purchase.
	ERROR 3	A CD cannot be played due to scratches, etc.	Replace with a non-scratched, non-warped-disc.
	ERROR 6	A CD is loaded upside-down inside the CD deck and does not play.	Eject the disc then reload it properly.
USB/MTP/iPod	ERROR 2	The files are not proper MP3/WMA/AAC format.	Use only properly encoded MP3/WMA/AAC files.
	ERROR 3 (USB/MTP mode)	The MP3/WMA/AAC files are improperly encoded.	Use only properly encoded MP3/WMA/AAC files.
	CUR ERR	Overcurrent detection.	Disconnect the devices and reconnect. If the devices are still not recognized, try replacing with a different devices.
	HUB ERR	Do not support the HUB devices.	Do not use the HUB devices.

If an error display other than the ones described above appears, press the reset button. If the problem persists, turn off the power and consult your store of purchase.

10. SPECIFICATIONS

FM Tuner

Frequency Range: 87.0 MHz to 108.0 MHz
 Usable Sensitivity: 11 dB μ V
 50dB Quieting Sensitivity: 17 dB μ V
 Alternate Channel Selectivity: 60 dB
 Stereo Separation (1 kHz): 30 dB
 Frequency Response (± 3 dB): 30 Hz to 15 kHz

AM Tuner

Frequency Range: 531 kHz to 1629 kHz
 Usable Sensitivity: 28 dB μ V

CD Player

System: Compact disc digital audio system
 Usable Discs: Compact disc
 Frequency Response (± 1 dB): 20 Hz to 20 kHz
 Signal to Noise Ratio (1 kHz): 92 dB
 Dynamic Range (1 kHz): 80 dB
 Harmonic Distortion: 0.03%

Bluetooth

Specification: Bluetooth Ver. 2.0
 Profile:

- HFP (Hands-Free Profile)
- OPP (Object Push Profile) Phone Book
- A2DP (Advanced Audio Distribution Profile)
- AVRCP (Audio/Video Remote Control Profile)

Send/Receive Sensitivity: Class 2

Note:

- Specifications and design are subject to change without notice for further improvement.

Audio

Maximum Power Output: 200 W (50 W \times 4 ch)
 Continuous Average Power Output:
 22 W \times 4, into 4 ohm, 20 Hz to 20 kHz, 1% THD
 Bass Control Action (100 Hz): +14 dB, -14 dB
 Treble Control Action (10 kHz): +14 dB, -14 dB
 Line Output Level (CD 1 kHz): 2 V

General

Power Supply Voltage:
 14.4 V DC (10.8 to 15.6 V allowable), negative ground
 Current Consumption: Less than 15 A
 Speaker Impedance: 4 Ω (4 Ω to 8 Ω allowable)
 Auto Antenna Rated Current: 500 mA or less
 Weight / Source unit: 1.14 kg
 Weight / Remote control unit:
 40 g (including battery)
 Dimensions / Source unit:
 178 (W) \times 50 (H) \times 155 (D) mm
 Dimensions / Remote control unit:
 44 (W) \times 113 (H) \times 11 (D) mm

11. OTHERS

WMDRM 10 for devices

- This product is protected by certain intellectual property rights of Microsoft. Use or distribution of such technology outside of this product is prohibited without a license from Microsoft.
- Content owners use Windows Media digital rights management technology (WMDRM) to protect their intellectual property, including copyrights. This device uses WMDRM software to access WMDRM-protected content. If the WMDRM software fails to

protect the content, content owners may ask Microsoft to revoke the software's ability to use WMDRM to play or copy protected content. Revocation does not affect unprotected content. When you download licenses for protected content, you agree that Microsoft may include a revocation list with the licenses. Content owners may require you to upgrade WMDRM to access their content. If you decline an upgrade, you will not be able to access content that requires the upgrade.

Clarion Co., Ltd.

All Rights Reserved. Copyright © 2009: Clarion Co., Ltd.

2009/02

PE-3155K
280-8765-00