

clarion®

Owner's manual

使用说明书

사용 설명서

DB266MP

CD/MP3 RECEIVER

CD/MP3接收机

CD/MP3리시버

Thank you for purchasing this **Clarion** product.

- * Please read this owner's manual in its entirety before operating this equipment.
- * After reading this manual, be sure to keep it in a handy place (e.g., glove compartment).
- * Check the contents of the enclosed warranty card and keep it carefully with this manual.

Contents

1. FEATURES	2
2. CONTROLS	3
SOURCE UNIT	3
DISPLAY	3
3. BUTTON TERMINOLOGY	4
Names of the Buttons and their Functions	4
4. PRECAUTIONS	5
5. HANDLING COMPACT DISCS	6
LCD Screen	6
6. DCP (Detachable Control Panel)	7
7. REMOTE CONTROL	8
Inserting the Battery	8
Functions of Remote Control Unit Buttons	9
8. OPERATIONS	10
Basic Operations	10
Radio Mode Operations	12
CD Mode Operations	13
MP3 Mode Operations	14
9. TROUBLESHOOTING	17
10. ERROR DISPLAYS	17
11. SPECIFICATIONS	18

1. FEATURES

- High contrast blue negative display (13 x 8 Digits) with screen saver
- MP3 compatible with ID3-TAG display
- "Z-ENHANCER" sound customisation & "MAGNA BASS EX" dynamic bass enhancement



Be sure to unfold and read the next page.

请务必展开并阅读下页。

반드시 다음 페이지를 펴서 읽으십시오.

2.CONTROLS/控制键/컨트롤

Note: Be sure to unfold this page and refer to the front diagrams as you read each chapter.

注意：阅读各章时请务必展开本页并参照前视图。

참고: 이 페이지를 펼쳐두고, 각 장을 읽을때 전면 그림을 참조하도록 하십시오.

SOURCE UNIT / 主机/헤드유닛

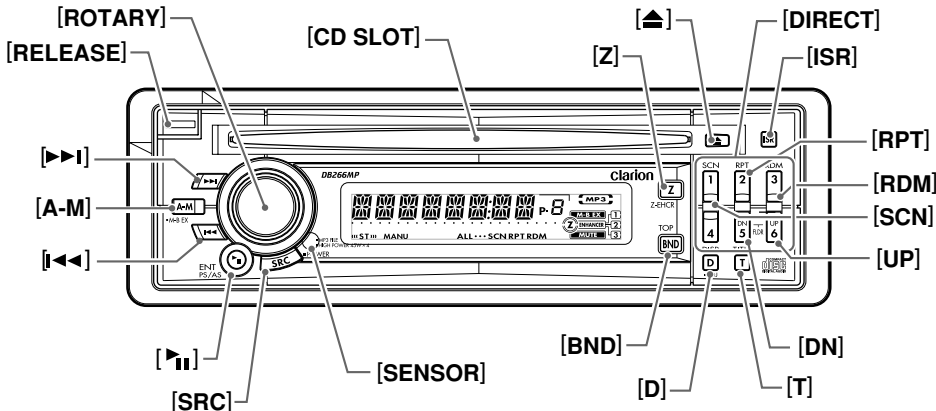

DISPLAY / 显示项目 / 화면 표시 항목

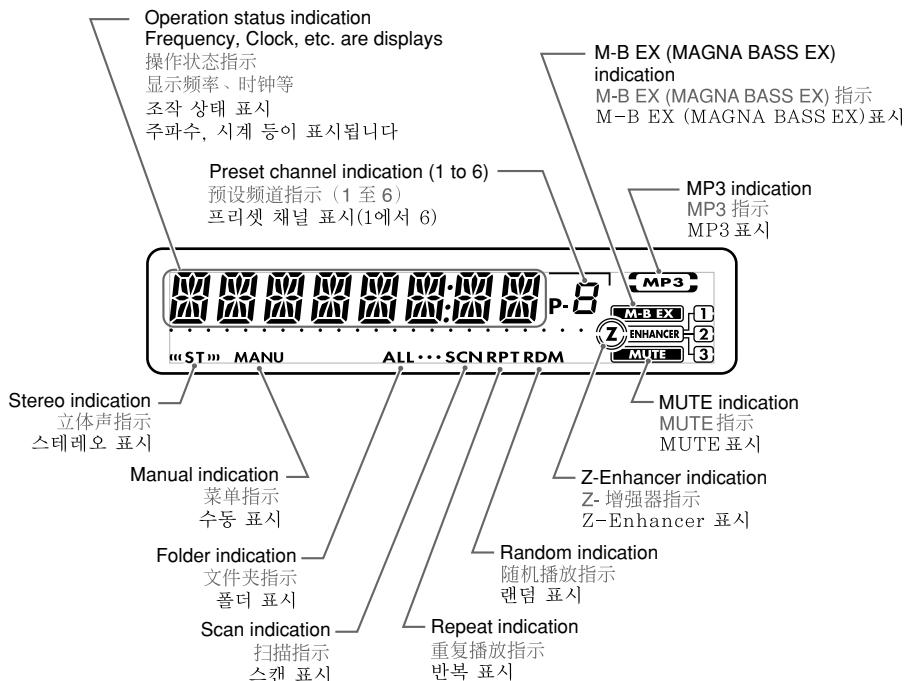

3. BUTTON TERMINOLOGY

Note:

- Be sure to read this chapter referring to the front diagrams of chapter "2. CONTROLS" on page 3 (unfold).

Names of the Buttons and their Functions

[RELEASE] button

- Press the [RELEASE] button to unlock the DCP.

[ROTARY] knob

- Adjust the volume by turning the knob clockwise or counterclockwise.
- Use the knob to perform various settings.

[CD SLOT]

- CD insertion slot.

[Z] button

- Use the button to select one of the three types of sound characteristics already stored in memory. (Z-Enhancer)

[▲] button

- Ejects a CD when it is loaded into the unit.

[DIRECT] button

- Stores a station into memory or recall it directly while in the radio mode.

[ISR] button

- Recalls ISR radio station in memory.
- Press and hold for 2 seconds or longer: Stores current station into ISR memory (radio mode only).

[RPT] button

- Plays repeatedly while in the CD/MP3 mode.

[RDM] button

- Performs random play while in the CD/MP3 mode.

[SCN] button

- Performs scan play for 10 seconds for each track while in the CD/MP3 mode.

[UP], [DN] button

- Play first track of next or previous folder which contain MP3 files.*
 - * Key function only available after MP3 indicator turned on.

[T] button

- Switches MP3 TITLE display.
- Press and hold for 1 second to scroll display data.

[D] button

- Switch the display indication (Main display, clock display).

MP3 FUNCTION-DISPLAY SELECTION

- Display changes in the following order: Track No. / Play time → Folder No. / Track No. → Title Display → Clock Display → Track No. / Play time...
- Long press to enter adjustment mode.

[BND] button

- Switches the band, or seek tuning or manual tuning while in the radio mode.
- Plays a first track while in the CD/MP3 mode.
- Press and hold the button to select between CD-DA playback and MP3 playback in multisession CD.

[SENSOR] button

- Receiver for remote control unit.
- Operating range: 30° in all directions.

[SRC] button

- Press the button to turn on the power. Press and hold the button for 1 second or longer to turn off the power.
- Switches the operation mode between radio and CD/MP3 mode.

[▶||] button

- Plays or pauses a CD while in the CD/MP3 mode.
- To enter various setting.
- Performs preset scan while in the radio mode. When the button is pressed and held, auto store is performed.

[A-M] button

- Press and hold the button for 1 second or longer to switch the MAGNA BASS EX on/off.
- Use the button to switch to the audio mode (bass/treble, balance/fader).

[◀◀], [▶▶] buttons

- Selects a station while in the radio mode or selects a track when listening to a CD/MP3.
- Press and hold the button for 1 second or longer to switches the fast-forward/fast-backward.

4. PRECAUTIONS

1. When the inside of the car is very cold and the player is used soon after switching on the heater moisture may form on the disc or the optical parts of the player and proper playback may not be possible. If moisture forms on the disc, wipe it off with a soft cloth. If moisture forms on the optical parts of the player, do not use the player for about one hour. The condensation will disappear naturally allowing normal operation.
2. Driving on extremely bumpy roads which cause severe vibration may cause the sound to skip.
3. This unit uses a precision mechanism. Even in the event that trouble arises, never open the case, disassemble the unit, or lubricate the rotating parts.

⚠ CAUTION

USE OF CONTROLS, ADJUSTMENTS, OR PERFORMANCE OF PROCEDURES OTHER THAN THOSE SPECIFIED HEREIN, MAY RESULT IN HAZARDOUS RADIATION EXPOSURE.

THE COMPACT DISC PLAYER SHOULD NOT BE ADJUSTED OR REPAIRED BY ANYONE EXCEPT PROPERLY QUALIFIED SERVICE PERSONNEL.

CHANGES OR MODIFICATIONS NOT EXPRESSLY APPROVED BY THE MANUFACTURER FOR COMPLIANCE COULD VOID THE USER'S AUTHORITY TO OPERATE THE EQUIPMENT.

INFORMATION FOR USERS:

CHANGES OR MODIFICATIONS TO THIS PRODUCT NOT APPROVED BY THE MANUFACTURER WILL VOID THE WARRANTY.

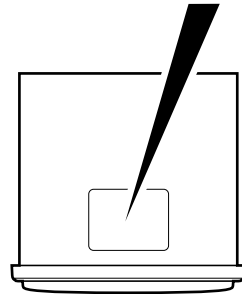
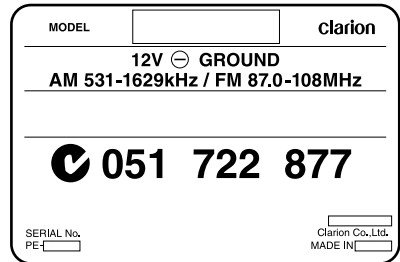

Bottom View of Source Unit

5. HANDLING COMPACT DISCS

Use only compact discs bearing the  mark.

Do not play heart-shaped, octagonal, or other specially shaped compact discs.

Some CDs recorded in CD-R/CD-RW mode may not be usable.

Handling

- Compared to ordinary music CDs, CD-R and CD-RW discs are both easily affected by high temperature and humidity and some of CD-R and CD-RW discs may not be played.

Therefore, do not leave them for a long time in the car.

- New discs may have some roughness around the edges. If such discs are used, the player may not work or the sound may skip. Use a ball-point pen or the like to remove any roughness from the edge of the disc.

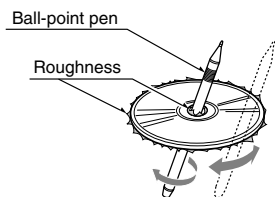

- Never stick labels on the surface of the compact disc or mark the surface with a pencil or pen.
- Never play a compact disc with any cellophane tape or other glue on it or with peeling off marks. If you try to play such a compact disc, you may not be able to get it back out of the CD player or it may damage the CD player.

- Do not use compact discs that have large scratches, are misshapen, cracked, etc. Use of such discs may cause misoperation or damage.
- To remove a compact disc from its storage case, press down on the center of the case and lift the disc out, holding it carefully by the edges.
- Do not use commercially available CD protection sheets or discs equipped with stabilizers, etc. These may damage the disc or cause breakdown of the internal mechanism.

Storage

- Do not expose compact discs to direct sunlight or any heat source.
- Do not expose compact discs to excess humidity or dust.
- Do not expose compact discs to direct heat from heaters.

Cleaning

- To remove fingermarks and dust, use a soft cloth and wipe in a straight line from the center of the compact disc to the circumference.
- Do not use any solvents, such as commercially available cleaners, anti-static spray, or thinner to clean compact discs.
- After using special compact disc cleaner, let the compact disc dry off well before playing it.

LCD Screen

In extreme cold, the screen movement may slow down and the screen may darken, but this is normal. The screen will recover when it returns to normal temperature.

6. DCP (Detachable Control Panel)

The control panel can be detached to prevent theft. When detaching the control panel, store it in the DCP (DETACHABLE CONTROL PANEL) case to prevent scratches.

We recommend taking the DCP with you when leaving the car.

Removing the DCP

1. Press the **[SRC]** button for 1 second or longer to switch off the power.
2. Press in the **[RELEASE]** button.

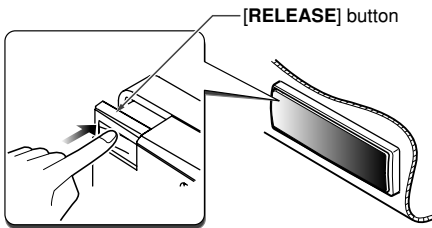

* The DCP is unlocked

3. Remove the DCP.

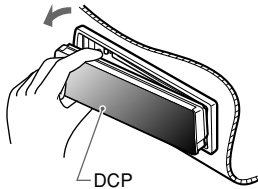

Attaching the DCP

1. Insert the right side of the DCP into the main unit.
2. Insert the left side of the DCP into the main unit.

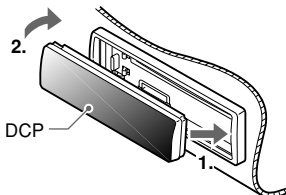

Storing the DCP in the DCP Case

Hold the DCP, in the orientation as shown in the figure below, and put it into the supplied DCP case. (Ensure the DCP is in the correct orientation.)

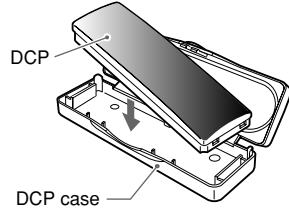

CAUTION

- The DCP can easily be damaged by shocks. After removing it, be careful not to drop it or subject it to strong shocks.
- When the **[RELEASE]** button is pressed and the DCP is unlocked, the car's vibrations may cause it to fall. To prevent damage to the DCP, always store it in its case after detaching it. (See figure above.)
- The connector connecting the main unit and the DCP is an extremely important part. Be careful not to damage it by pressing on it with fingernails, pens, screwdrivers, etc.

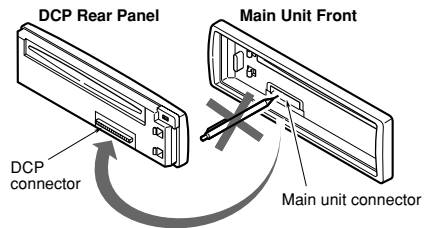

Note:

- If the DCP is dirty, wipe off the dirt with a soft, dry cloth only.

7. REMOTE CONTROL

If you buy the RCB-176-600 sold separately, you can enjoy the use of the Remote Control function.

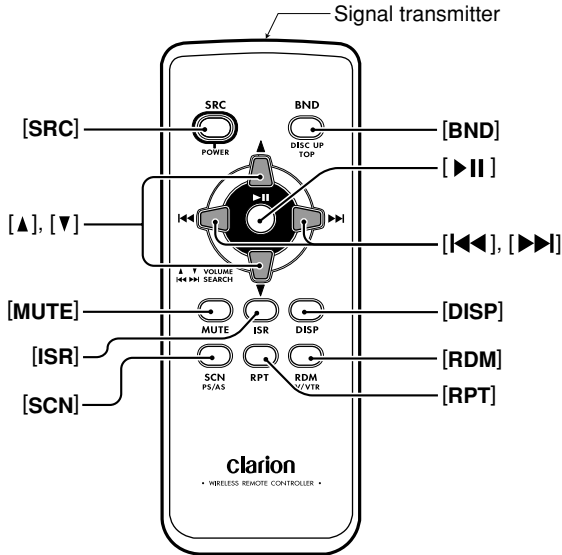

Inserting the Battery

- ① Turn over the remote control unit and slide the cover in the direction indicated by the arrow in the illustration.
- ② Insert the battery (CR2025) into the insertion guides, with the printed side (+) facing upwards.
- ③ Press the battery in the direction indicated by the arrow so that it slides into the compartment.
- ④ Replace the cover and slide in until it clicks into place.

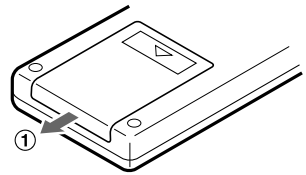

Notes:

Misuse may result in rupture of the battery, producing leakage of fluid and resulting in personal injury or damage to surrounding materials. Always follow these safety precautions:

- Use only the designated battery.
- When replacing the battery, insert properly, with +/- polarities oriented correctly.
- Do not subject battery to heat, or dispose of in fire or water. Do not attempt to disassemble the battery.
- Dispose of used batteries properly.

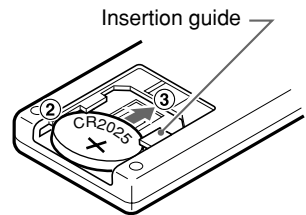

Functions of Remote Control Unit Buttons

Mode Button	Radio	CD	MP3
[SRC]	Turns power on and off. When press and held for 1 second: Turns power off. Switches between radio and CD/MP3.		
[BND]	Switches reception band.	Plays the first track. Top play.	Plays the first track of the current folder.
[▲], [▼]	Increases and decreases volume (in all modes).		
[◀◀], [▶▶]	Moves preset channels up and down.	Moves tracks up and down. When pressed and held for 1 second: Fast-forward/fast-backward.	
[▶▶]	No function	Switches between playback and pause.	
[MUTE]	Turns mute on and off.	Switches between playback and pause.	
[ISR]	Recalls ISR radio station in memory. Press and hold for 2 seconds or longer: Stores current station into ISR (radio mode only).		
[DISP]	Switches between main display and clock display.		Switch among main display, folder number display, TITLE display, clock display.
[SCN]	Preset scan. When pressed and held for 2 seconds: Auto store.	Scan play.	Scan play. When pressed and held for 1 second or longer: Folder scan.
[RPT]	No function	Repeat play.	Repeat play. When pressed and held for 1 second or longer: Folder repeat.
[RDM]	No function	Random play.	Random play. When pressed and held for 1 second or longer: Folder random.

* Some of the corresponding buttons on the main unit and remote control unit have different functions.

8. OPERATIONS

Basic Operations

Note: Be sure to read this chapter referring to the front diagrams of chapter "2. CONTROLS" on page 3 (unfold).

▲ CAUTION

Be sure to lower the volume before switching off the unit power or the ignition key. The unit remembers its last volume setting. If you switch the power off with the volume up, when you switch the power back on, the sudden loud volume may hurt your hearing and damage the unit.

Turning on/off the power

Note:

• Be careful about using this unit for a long time without running the engine. If you drain the car's battery too far, you may not be able to start the engine and this can reduce the service life of the battery.

1. Press the [SRC] button.
2. The illumination and display on the unit light up. The unit automatically remembers its last operation mode and will automatically switch to display that mode.
3. Press and hold the [SRC] button for 1 second or longer to turn off the power for the unit.

Selecting a mode

1. Press the [SRC] button to change the operation mode.
2. Each time you press the [SRC] button, the operation mode changes in the following order:
Radio mode → CD/MP3 mode → Radio mode...

Note:

• If the CD/MP3 mode is selected when no disc is inserted, the display shows "NO DISC".

Adjusting the volume

Turning the [ROTARY] knob clockwise increases the volume; turning it counterclockwise decreases the volume.

* The volume level is from 0 (minimum) to 33 (maximum).

Setting the Z-Enhancer

This unit are provided with 3 types of sound tone effects stored in memory. Select the one you prefer.

* The factory default setting is "Z-EHCR OFF".

Each time you press the [Z] button, the tone effect changes in the following order:

Z-ENHANCER 1 → Z-ENHANCER 2 →
Z-ENHANCER 3 → Z-EHCR OFF →
Z-ENHANCER 1...

- Z-ENHANCER 1 : bass emphasized
- Z-ENHANCER 2 : treble emphasized
- Z-ENHANCER 3 : bass and treble emphasized
- Z-EHCR OFF : no sound effect

Audio mode adjustments

1. Press the [A-M] button to select the adjustment mode. The mode switches as follows each time the [A-M] button is pressed:
BASS → TREB → BAL → FAD → Previous mode
* When the Z-Enhancer function is turned on, BASS (Bass) and TREB (Treble) cannot be selected.
2. Turning the [ROTARY] knob to adjust the selected audio mode.
BASS (Bass) : Adjustment range: -7 to +7
TREB (Treble) : Adjustment range: -7 to +7
BAL (Balance) : Adjustment range: L13 to R13
FAD (Fader) : Adjustment range: F12 to R12
3. When the adjustment is complete, press the [A-M] button several times until the function mode is reached.

Note:

• During audio adjustment mode, if no operation is performed for more than 7 seconds, this mode can be cancelled and return to previous mode.

Turning on/off MAGNA BASS EX

The MAGNA BASS EX does not adjust the low sound area like the normal sound adjustment function, but emphasizes the deep bass sound area to provide you with a dynamic sound.

* The factory default setting is off.

Press and hold the [A-M] button for 1 second or longer to turn the MAGNA BASS EX and "M-B EX" in the display lights on or off.

Switching display

Press the [D] button to select the desired display.

The display switches in the following order:

Main Display → Clock Display →

Main Display ...

* If the display is changed by other button operation when the clock is displayed, the clock display returns automatically after the operation.

Illumination dimmer function

When the illumination line of this unit is connected with the car-side illumination signal line, the display illumination of this unit dims in connection with turning on the car-side illumination.

ADJ mode adjustment

1. Press [D] button more than 1 second at POWER ON mode to enter ADJ mode, the previous selected ADJ items will be called out.
2. Press [D] button again at ADJ mode will cancel ADJ mode and return to previous display.
3. Press [SRC] button will also release ADJ mode.
4. ADJ mode will also be released when current source mode is changed. (Mode changes of LOADING, EJECT, interruption and interruption release)
5. Press [◀◀]/[▶▶] button to switch the ADJ mode items,

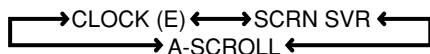

6. The ADJ mode title will be display for 2 seconds before showing the ADJ mode setting.

Adjusting clock setting

1. Press the [D] button and press [◀◀]/[▶▶] button to select "CLOCK (E)".
2. Press [▶] button to start clock adjustment, the HOUR is selected and blinking by default.
3. Press [◀◀]/[▶▶] button to toggle HOUR and MINUTE selection.
4. Turn the [ROTARY] knob clockwise to increases hour/minute or counterclockwise to decrease hour/minute.
5. Press [▶] button to confirm the clock setting the clock will blink for 2 seconds and return to "CLOCK(E)".

Note:

• If you remove the vehicle's battery for a check or repair, the clock will be reset, so you must set it again.

Adjusting screen saver setting

1. Press the [D] button and press [◀◀]/[▶▶] button to select "SCR N SVR".
2. "SS ON" or "SS OFF" will be display after 2 seconds.
3. Turn the [ROTARY] knob clockwise to turn on the screen saver or counterclockwise to turn off the screen saver.
4. If screen saver setting is set to on, screen saver will be activated after 30 seconds of no key operation.

Adjusting auto-scroll setting

1. Press the [D] button and press [◀◀]/[▶▶] button to select "A-SCROLL".
2. "SCRL ON" or "SCRL OFF" will be display after 2 seconds.
3. Turn the [ROTARY] knob clockwise to turn on the auto-scroll or counterclockwise to turn off the auto-scroll.
4. If auto-scroll setting is set to on, the MP3 title will scroll continuously in MP3 title display mode.

Radio Mode Operations

Listening to the radio

1. Press the [SRC] button and select the radio mode. Then the radio will be on.
2. To select a preset band, press the [BND] button, then select one of the preset bands such as FM1, FM2, FM3 or AM. Every time the [BND] button is pressed, the display will change as:
F1 → F2 → F3 → AM → F1...
3. Press the [◀◀] or [▶▶] button to tune in the desired station.

Manual tuning

1. Press the [BND] button to select the desired band FM1, FM2, FM3 or AM.
2. Press and hold the [BND] button for 1 second or longer, then the "MANU" is lit in the display, which means that a manual selection function is on.
3. Press the [◀◀] or [▶▶] button to manually tune in a station.

Seek tuning

1. Press the [BND] button to select the desired band FM1, FM2, FM3 or AM.
2. If the "MANU" is lit in the display, press and hold the [BND] button for 1 second or longer. When the "MANU" display is off, the seek tuning is now available.
3. Press the [◀◀] or [▶▶] button to automatically seek in a station.

Preset memory function

Preset memory function can store up to 24 stations: six stations for each of FM1, FM2, FM3 and AM.

Manual memory function

1. Press the [BND] button, to select a band you want to store in the memory.
2. Press the [◀◀] or [▶▶] button to tune into a desired station.
3. Press and hold one of the [DIRECT] button for 2 seconds or longer to store the current station into preset memory.

Auto store function

(Automatic Station Store)

1. Press [BND] button to select the desired band FM1, FM2, FM3 or AM.
2. Press and hold the [▶||] button for 1 second or longer. The stations at which the reception is the strongest will be automatically stored in the memory.

Notes:

- When the auto store is performed, the station previously store in the memory at that position is overwritten.
- When the number of stations stored is less than six, the previous content of the memory for each direct button will be retained.

Preset scanning

(Preset Station Scan)

When the [▶||] button is pressed, the "SCN" will be indicated with preset memory numbers and the stations are tuned in for 7 seconds each in the order in which they were stored. Press the [▶||] button again to cancel the preset scanning mode.

Instant station recall (ISR)

With this function, a specific radio station can be recalled from any mode.

ISR memory

1. Press the [SRC] button, then select the radio mode.
2. Select the radio station which you want to store in the memory.
3. Press and hold the [ISR] button for 2 seconds or longer.

Recalling ISR

Press the [ISR] button and the display will show "ISR". Then the radio station previously memorized will be selected. Press the [ISR] button again to disengage the unit from the Recalling ISR function.

CD Mode Operations

Loading a CD

Insert a CD into the center of the CD insertion slot with the labeled side facing up. "LOADING" appears in the display, the CD enters into the slot and start playing.

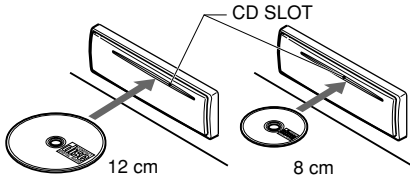

Notes:

- Do not put your hand, fingers, or foreign objects into the CD insertion slot.
- If a CD has already been loaded, another CD cannot be inserted. Do not insert another one forcefully.
- Discs not bearing the  mark cannot be played with the unit. CD-ROMs cannot be played.
- Some CDs recorded in CD-R/CD-RW mode may not be usable.

Loading 8cm compact discs:

- No adapter is required to play an 8cm CD.
- Insert the 8cm CD into the center of the insertion slot.

Listening to the disc already inserted

Press the [SRC] button to select the CD/MP3 mode, the CD will start playing.

Stopping (Pausing) playback

While the CD playing, pressing the [⏏] button will stop the CD and "PAUSE" indicate.

Press the [⏏] button again to resume playback.

Ejecting the CD

Press the [⏏] button, then the CD will be ejected.

Note:

- If the ejected CD is left as it is, it will be reloaded after 15 seconds.
- 8cm CDs are not auto reloaded. Be sure to remove them when ejected.

Top function

Press the [BND] button, then the CD will start playing from the first song (track number 1).

- * For MP3 mode, it will start playing from the first song of current folder.

Selecting tracks (Songs)

Press the [⏮] or [⏭] button.

▶▶ : Playback will start from the next track.

◀◀ : Playback will start from the beginning of the track currently playing. When this button is pressed again, the CD will play from the previous track.

- * For MP3 mode, track selection is only valid in current folder.

Fast-forward and fast-backward

Press and hold the [⏮] or [⏭] button.

▶▶▶ : To fast-forward

◀◀◀ : To fast-backward

- * For Audio CD mode pressing the [⏮] or [⏭] button for 1 second or longer will move forward or backward 5 times faster than normal play, and pressing it for 3 seconds or longer will do the operation 30 times faster.
- * For MP3 mode, pressing the [⏮] or [⏭] button for 1 second or longer will move forward or backward 10 times faster than normal play.

Scan play (Intro Music Scan)

At Audio CD press the [SCN] button, the "SCN" is lit & display shows "TRK SCN", then the CD will play the first 10 seconds of each track of the whole disc. Press the [SCN] button again to disengage the unit from scan play.

- * A scan play will start from the track following the one currently playing.

Repeat play

At Audio CD press the [RPT] button, the "RPT" is lit & display shows "TRK RPT", then the track currently playing will be played repeatedly. Press the [RPT] button again to disengage the unit from repeat play.

Random play

At Audio CD press the [RDM] button, the "RDM" is lit & display shows "TRK RDM", then the entire tracks on the disc will be played at random. Press the [RDM] button again to disengage the unit from random play.

MP3 Mode Operations

What is MP3?

MP3 is an audio compression method and classified into audio layer 3 of MPEG standards. This audio compression method has penetrated into PC users and become a standard format. This MP3 features the original audio data compression to about 10 percent of its initial size with a high quality sound. This means that about 10 music CDs can be recorded on a CD-R disc or CD-RW disc to allow a long listening time without having to change CDs.

Precautions when creating MP3 disc

● File extensions

- Always add a file extension “.MP3” to MP3 file by using single byte letters. If you add a file extension other than specified or forget to add the file extension, the file cannot be played.

● Logical format (File system)

- When writing MP3 file on a CD-R disc or CD-RW disc, please select ISO9660 level 1, 2, Joliet or Romeo as the writing software format. Normal play may not be possible if the disc is recorded on another format.
- The folder name and file name can be displayed as the title during MP3 play but the title must be within 16 (Folder Name) or 28 (File Name) single byte alphabetical letters and numerals (excluding an extension).

● Number of files or folders

- The MP3 recording media reproducible on this unit has the following limitations :
 1. Maximum number of files : 254
 2. Maximum number of folders : 128
 3. Some noise may occur depending on the type of encoder software used while recording.

Folder up down function

1. This function enables you to search for a folder on the MP3 CD. The LCD will show the target MP3 CD folder.

[UP] – Folder up

[DN] – Folder down

2. When a desired folder is selected, the CD player will play 1st track of target folder.

Note:

- The folder which contents of no MP3 file will be skipped.

MP3 playing order

When selected for play folder up down functions, files and folders are accessed in the order in which they were written by the CD-ROM writer. Because of this, the order in which they are expected to be played may not match the order in which they are actually played. You may be able to set the order in which MP3 are to be played by writing them onto a medium such as a CD-R with their file names beginning with play sequence numbers such as “01” to “99”, depending on your CD writer.

For example, a medium with the following folder/file hierarchy is shown below.

Example of a medium's folder/file hierarchy

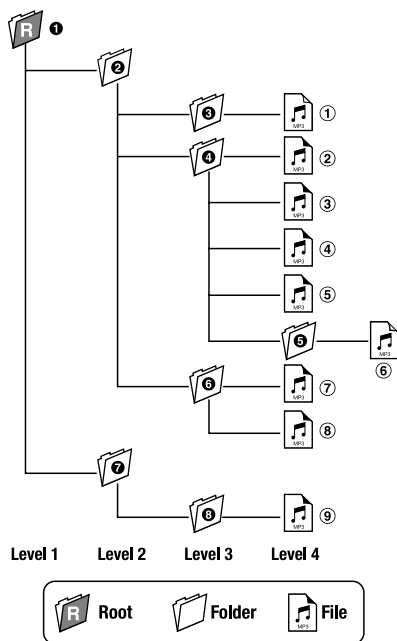

Random MP3 CD

1. This function enables you to play all the tracks in the MP3 folder or on the disc in random order.
2. There are 2 types of random play accessible for MP3 CDs; random track and random all folders.

MP3 Mode Operations

Random access	Function	Display	Indicator
Press the [RDM] button less than 1 second	Random track in current folder	"TRK RDM"	"RDM"
Press the [RDM] button more than 1 second	Random track in all folders	"FLDR RDM"	"ALL..." & "RDM"

- Each time the button is pressed, random play turns on or off.

Repeat MP3 CD

- This function enables you to replay the track or folder you are listening to.
- There are 2 types of repeat play accessible for MP3 CD; repeat track and repeat current folder.

Repeat access	Function	Display	Indicator
Press the [RPT] button less than 1 second	Repeat current song	"TRK RPT"	"RPT"
Press the [RPT] button more than 1 second	Repeat current folder	"FLDR RPT"	"ALL..." & "RPT"

- Each time the button is pressed, repeat play turns on or off.

Scan MP3 CD

- This function enables you to play the first 10 seconds of each track in the MP3 folder or the first track of each folder.
- There are 2 types of scan play accessible for MP3 CD; scan track and scan all folders.

Scan access	Function	Display	Indicator
Press the [SCN] button less than 1 second	Scan in current folder	"TRK SCN"	"SCN"
Press the [SCN] button more than 1 second	Scan track in all folder	"FLDR SCN"	"ALL..." & "SCN"

- Each time the button is pressed, scan play turns on or off.

Display selection

- You can choose the display type for MP3 CD by pressing the [D] button.

To select the next type, press the [D] button again.

The arrangement is shown below.

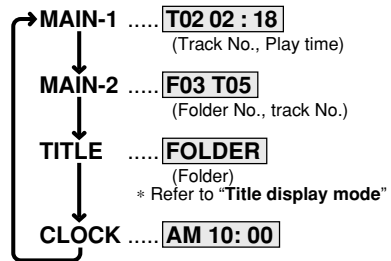

Title display mode

- There are 5 types of display for the title display mode.
- To select the next type, press the [T] button for less than 1 second.

The arrangement is shown below.

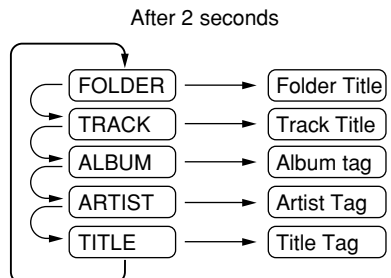

MP3 Mode Operations

- The displayed item can be scrolled by pressing the [T] button for more than 1 second.
- If a MP3 file does not support for ID3 TAG, the display will show "**NO TAG**".
- If a MP3 file encode with ID3 TAG header but no consist of any TAG information, the display will show nothing.

Notes:

- The folder name will be displayed as "**ROOT**" which the file allocates in the root folder.
- The MP3 player decodes each file ID3 TAG ver 2 by default, if ID3 TAG ver 2 is unavailable, ID3 TAG ver 1 will be decoded.
- UNICODE ID3 (Chinese, Japanese and etc) is not supported.

CD-DA/MP3 selection on multisession CD

- If a multisession CD which contains CD-DA and MP3 files is being inserted, user can select either CD-DA or MP3 files to be played.
- Default setting for files to be played on multisession CD is CD-DA files.
- Press the [BND] button for more than 1 second will toggle between selection of CD-DA and MP3 files to be played.

- When CD-DA type is selected, display will show "**M-S CD**". When MP3 type is selected, display will show "**M-S MP3**".
- CD-DA/MP3 selection function can only be performed in CD/MP3 mode. It will only activate after re-insert CD. For example, current setting is CD-DA type. Press [BND] button for more than 1 second to set MP3 type. User has to eject CD and re-insert it again as to play MP3 files.
- Types of recording that can be played are as follows.

Disc \ Setting	Set to CD	Set to MP3
Mixed with CD and MP3 type tracks	Play CD	Play MP3
CD type track only	Play CD	Play CD
MP3 type track only	Play MP3	Play MP3

- When a mixed mode CD is loaded and CD is set, the track to be played first is MP3 file data and no sound is heard.

9. TROUBLESHOOTING

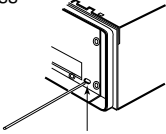
Problem	Cause	Solution
Power does not turn on. (No sound is produced)	Fuse is blown.	Replace with a fuse of the same amperage. If the fuse blows again, consult your store of purchase.
	Incorrect wiring.	Consult your store of purchase.
Compact disc cannot be loaded.	Another compact disc is already loaded.	Eject the compact disc before loading the new one.
Sound skips or is noisy.	Compact disc is dirty.	Clean the compact disc with a soft cloth.
	Compact disc is heavily scratched or warped.	Replace with a compact disc with no scratches.
Sound is bad directly after power is turned on.	Water droplets may form on the internal lens when the car is parked in a humid place.	Let dry for about 1 hour with the power on.
Nothing happens when button are pressed. Display is not accurate.	The microprocessor has malfunctioned due to noise, etc.	Turn off the power, then press the [RELEASE] button and remove the DCP. Press the reset button for about 2 seconds with a thin rod. <div style="text-align: right;">  <p>Reset button</p> </div>
	DCP or main unit connectors are dirty.	Wipe the dirt off with a soft cloth moistened with cleaning alcohol.

10. ERROR DISPLAYS

- To protect the system, this unit has been equipped with self diagnostic functions. If a fault arises, a warning is issued by various error displays. Follow the corrective measures and remove the fault.

Error Display	Corrective Measure
ERROR 2	This error display indicates that a fault has arisen in the mechanism of the source unit (for example, the disc cannot be ejected). → Check the source unit.
ERROR 3	This error display indicates that the pickup focus is off because of a scratched disc or some other factor during source unit play. → Check the compact disc.
ERROR 6	This indicates that the CD's TOC (table of contents) cannot be read, for example because the selected disc is upside-down.

11. SPECIFICATIONS

FM tuner

Frequency Range: 87.0 MHz to 108.0 MHz
 Usable Sensitivity: 11 dBf
 50 dB Quieting Sensitivity: 17 dBf
 Alternate Channel Selectivity: 75 dB
 Stereo Separation (1 kHz): 35 dB
 Frequency Response (± 3 dB): 30 Hz to 15 kHz

AM tuner

Frequency Range:
 AM: 531 kHz to 1629 kHz
 Usable Sensitivity: 25 μ V

CD player

System: Compact disc audio system
 Usable Discs: Compact disc
 Frequency Response: 10 Hz to 20 kHz (± 1 dB)
 Signal to Noise Ratio (1 kHz): 100 dB IHF-A
 Dynamic Range: 95 dB (1 kHz)
 Harmonic Distortion: 0.01%

MP3

Decode Format: MPEG 1, 2 and 2.5 -Layer 3
 Sampling rate (kHz):
 MPEG-1: 32, 44.1, 48
 MPEG-2: 16, 22.05, 24
 MPEG-2.5: 11.025, 12

Bit-rate (kbps):

8, 16, 24, 32, 40, 48, 56, 64, 80, 96, 112, 128,
 144, 160, 192, 224, 256, 320, VBR

CD-ROM Format:

ISO9660 level 1, 2, Joliet or Romeo
 Folder Level Limit: No limitation
 Folder Support: 128
 File Support: 254
 Folder Name: Maximum 16 characters
 File Name: Maximum 28 characters

Audio

Maximum Power Output: 180 W (45 W \times 4 ch)
 Continuous Average Power Output:
 17 W \times 4, into 4 Ω , 20 Hz to 20 kHz, 1%THD
 Bass Control Action (100 Hz): ± 14 dB
 Treble Control Action (10 kHz): ± 14 dB
 Line Output (with A/C 1 kHz, 10 k Ω): 1.8 V

General

Power Supply Voltage:
 14.4 V DC (10.8 V to 15.6 V allowable),
 negative ground
 Current Consumption: Less than 15 A
 Speaker Impedance: 4 Ω (4 Ω to 8 Ω allowable)
 Weight: 1.1 kg
 Dimensions:
 178 mm Width \times 50 mm Height \times 152 mm
 Depth

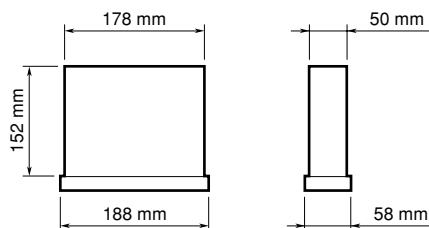

Notes:

- Specifications and design are subject to change without notice for further improvement.
- Please make sure when connecting external power amplifier, that you properly, to the car chassis, ground the amplifier.
- If this is not done, severe damage to the source unit may happen.

Clarion Co., Ltd.

All Rights Reserved. Copyright © 2005: Clarion Co., Ltd.
Printed in China / 在中国印刷 / 중국에서 인쇄

2005/12 (A-C)

PE-2793K
280-8355-00