

clarion®

Owner's manual

使用说明书

사용 설명서

DFZ667MC

**2-DIN CD/SD/MP3/WMA RECIEVER/
CeNET CONTROL/MUSIC CATCHER®II**

**2-DIN CD/SD/MP3/WMA接收器/
CeNET控制/MUSIC CATCHER®II**

**2DIN CD/SD/MP3/WMA 리시버/
CeNET 컨트롤/MUSIC CATCHER®II**

Thank you for purchasing this **Clarion** product.

* Please read this owner's manual in its entirety before operating this equipment.

* After reading this manual, be sure to keep it in a handy place (e.g., glove compartment).

* This manual includes the operating procedures of the CD changer and TV tuner connected via the CeNET cable. The CD changer and TV tuner have their own manuals, but no explanations for operating them are described.

Contents

1. FEATURES	2
2. PRECAUTIONS	3
Handling Compact Discs/SD memory card	4
3. CONTROLS	5
4. NOMENCLATURE	6
Names of the Buttons and their Functions	6
Major Button Operations When External Equipment is Connected to This Unit.....	8
Display Items	9
Display Screen	9
5. REMOTE CONTROL	10
Inserting the Battery	10
Functions of Remote Control Unit Buttons	11
6. OPERATIONS	12
Basic Operations	12
Radio Operations	15
CD/MP3/WMA, SD memory card, and MUSIC CATCHER II (Playing) Operations	17
MUSIC CATCHER II (Recording/Erasing) Operations	21
Common Operations	23
7. OPERATIONS OF ACCESSORIES	27
CD Changer Operations	27
TV Operations	29
iPod Operations	31
8. TROUBLE SHOOTING	33
9. ERROR DISPLAYS	35
10. SPECIFICATIONS	36

1. FEATURES



MUSIC CATCHER



- MUSIC CATCHER®II for recording Audio CD
- MP3 and WMA compatible with CD/SD memory card device
- 4-Channel RCA output & Front-Panel Auxiliary Input

2. PRECAUTIONS

1. When the inside of the car is very cold and the player is used soon after switching on the heater moisture may form on the disc or the optical parts of the player and proper playback may not be possible. If moisture forms on the disc, wipe it off with a soft cloth. If moisture forms on the optical parts of the player, do not use the player for about one hour. The condensation will disappear naturally allowing normal operation.
2. Driving on extremely bumpy roads which cause severe vibration may cause the sound to skip.
3. This unit uses a precision mechanism. Even in the event that trouble arises, never open the case, disassemble the unit, or lubricate the rotating parts.

CAUTION

USE OF CONTROLS, ADJUSTMENTS, OR PERFORMANCE OF PROCEDURES OTHER THAN THOSE SPECIFIED HEREIN, MAY RESULT IN HAZARDOUS RADIATION EXPOSURE.



THE COMPACT DISC PLAYER and MINI DISC PLAYER SHOULD NOT BE ADJUSTED OR REPAIRED BY ANYONE EXCEPT PROPERLY QUALIFIED SERVICE PERSONNEL. CHANGES OR MODIFICATIONS NOT EXPRESSLY APPROVED BY THE MANUFACTURER FOR COMPLIANCE COULD VOID THE USER'S AUTHORITY TO OPERATE THE EQUIPMENT.

INFORMATION FOR USERS:

CHANGES OR MODIFICATIONS TO THIS PRODUCT NOT APPROVED BY THE MANUFACTURER WILL VOID THE WARRANTY.

Handling Compact Discs/SD memory card

Compact Discs

Use only compact discs bearing the  or  mark.

Do not play heart-shaped, octagonal, or other specially shaped compact discs.

Some CDs recorded in CD-R/CD-RW mode may not be usable.

Handling

- Compared to ordinary music CDs, CD-R and CD-RW discs are both easily affected by high temperature and humidity and some of CD-R and CD-RW discs may not be played. Therefore, do not leave them for a long time in the car.
- New discs may have some roughness around the edges. If such discs are used, the player may not work or the sound may skip. Use a ball-point pen or the like to remove any roughness from the edge of the disc.

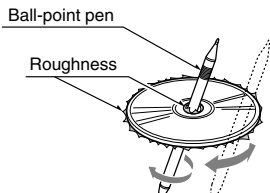

- Never stick labels on the surface of the compact disc or mark the surface with a pencil or pen.
- Never play a compact disc with any cellophane tape or other glue on it or with peeling off marks. If you try to play such a compact disc, you may not be able to get it back out of the CD player or it may damage the CD player.
- Do not use compact discs that have large scratches, are misshapen, cracked, etc. Use of such discs may cause misoperation or damage.
- To remove a compact disc from its storage case, press down on the center of the case and lift the disc out, holding it carefully by the edges.
- Do not use commercially available CD protection sheets or discs equipped with stabilizers, etc. These may damage the disc or cause breakdown of the internal mechanism.

Storage

- Do not expose compact discs to direct sunlight or any heat source.
- Do not expose compact discs to excess humidity or dust.
- Do not expose compact discs to direct heat from heaters.

Cleaning

- To remove fingermarks and dust, use a soft cloth and wipe in a straight line from the center of the compact disc to the circumference.
- Do not use any solvents, such as commercially available cleaners, anti-static spray, or thinner to clean compact discs.
- After using special compact disc cleaner, let the compact disc dry off well before playing it.

SD memory card

SD MEMORY CARD SLOT

- This equipment has SD MEMORY CARD SLOT. Ensure high compatibility with various kinds of digital equipment or file format. Play back MP3 and WMA files without, for example, the use of a PC.

Handling

- After eject operation, always remove SD memory card from its slot; otherwise, SD memory card may fall down (due to, for example, car vibration, etc) during driving.
- This equipment does not support miniSD card and MMC (Multi Media Card) formats.

3. CONTROLS / 控制键 / 컨트롤

Source unit / 主机 / 본체

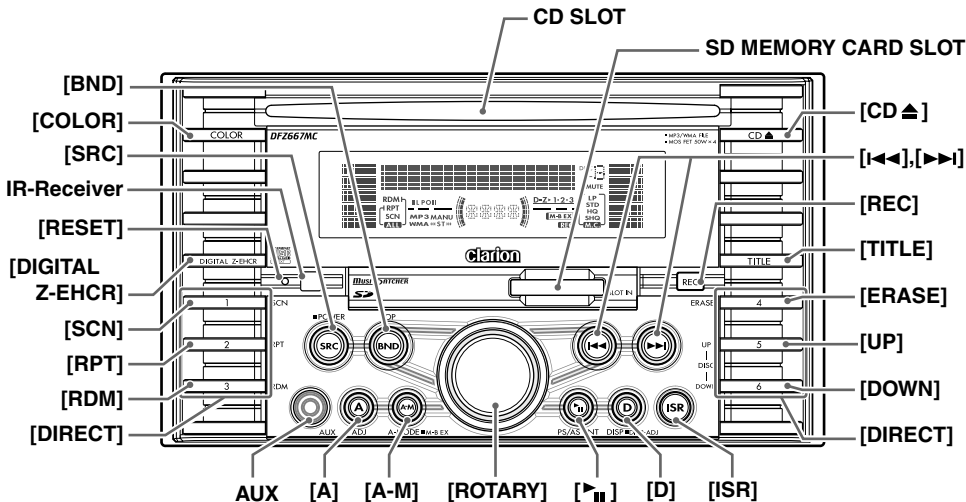

Note: Be sure to unfold this page and refer to the front diagrams as you read each chapter.

注: 请务必打开此页, 并在阅读每一章节时参照上面的正视图。

주: 이 페이지를 펼쳐두고, 각 장을 읽을 때 전면 그림을 참조하십시오.

4. NOMENCLATURE

Notes:

- Be sure to read this chapter referring to the front diagrams of chapter "3. CONTROLS" on page 5 (unfold).
- MC is the abbreviation of MUSIC CATCHER II.
- SD is the abbreviation of SD memory card.

Names of the Buttons and their Functions

CD SLOT

- CD insertion slot.

SD MEMORY CARD SLOT

- SD memory card insertion slot.

[CD] button

- Eject a CD loaded in the unit.

[◀◀], [▶▶] buttons

- Select a station while in the radio mode or select a track when listening to a CD/MP3/WMA, MC, SD mode. Perform various settings.
- Press and hold the button for 1 second or longer to switch the fast-forward/fast-rewind.

[REC] button

- During CD playback, and the track currently being played back is recorded onto MC (TRACK REC).
- Press and hold the button for 2 seconds or longer during CD playback, and all tracks are recorded onto MC (DISC REC).

[TITLE] button

- Input a title in the Radio, CD, MC mode.
- Press the button to switch the current displayed title on the title display.

[ERASE] button

- In the MC mode, switch in the following order: FILE ERASE → FLD ERASE → Normal mode.
- Press and hold the button for 2 seconds or longer, to enter the ALL ERASE mode.

[UP], [DOWN] buttons

- Select the Folder (MP3/WMA disc, MC, SD mode only).

[DIRECT] buttons

- Store a station into memory or recall it directly while in the radio mode.

[ISR] button

- Recall ISR radio station in memory.
- Press and hold the button for 2 seconds or longer: Store current station into ISR memory (radio mode only).

[D] button

- Switch the display indication.

[⏮] button

- Play or pause a CD while in the CD/MP3/WMA, MC, SD mode.
- Press and hold the button for 2 seconds or longer after selecting the ERASE mode, and the track is erased.
- Perform preset scan while in the radio mode.
- Press and hold the button for 2 seconds or longer, auto store is performed.

[ROTARY] knob

- Adjust the volume by turning the knob clockwise or counterclockwise.
- Perform various settings.

[A-M] button

- Switch to the audio mode.
- Press and hold the button for 1 second or longer to turn on or off the MAGNA BASS EXTEND.

[A] button

- Enter the adjust mode.

AUX input jack

- Connect external equipment to this unit.

[RDM] button

- Perform random play while in the CD/MP3/WMA, MC, SD mode.
- Press and hold the button for 1 second or longer to perform folder random play while in the MP3/WMA disc, MC, SD mode.

[RPT] button

- Repeat play while in the CD/MP3/WMA, MC, SD mode.
- Press and hold the button for 1 second or longer to perform folder repeat play while in the MP3/WMA disc, MC, SD mode.

[SCN] button

- Perform scan play for 10 seconds of each track while in the CD/MP3/WMA, MC, SD mode.
- Press and hold the button for 1 second or longer to perform folder scan play while in the MP3/WMA disc, MC, SD mode.

[DIGITAL Z-EHCR] button

- Select one of the 3 types of sound characteristics already stored in memory.

[RESET] button

- Press and hold the button for 2 seconds or longer to clear frequencies of TV/radio stations, titles, etc, stored in memory.
- Press and hold the button for 2 seconds or longer when Anti-theft function is out of order.

IR-Receiver

- Receiver for remote control unit (operating range: 30° in all directions)

[SRC] button

- Turn on the power.
- Press and hold the button for 1 second or longer to turn off the power.
- Switch the operation mode among the radio mode, etc.

[COLOR] button

- Button's color change to Variable color.

[BND] button

- Switch the band, or seek tuning or manual tuning while in the radio mode.
- Play a first track while in the CD/MP3/WMA, MC, SD mode.

Major Button Operations When External Equipment is Connected to This Unit

When the CD/DVD changer is connected

* For details, see the section “**CD Changer Operations**” (page 27). For the DVD changer, refer to the Owner’s Manual provided with the DVD changer.

[◀◀], [▶▶] buttons

- Select a track when listening to a disc.
- Press and hold the button for 1 second or longer to switch the fast-forward/fast-rewind.

[TITLE] button

- Use the button to input a title in the CD changer mode.

[UP], [DOWN] buttons

- Select the disc.

[D] button

- Press and hold the button for 1 second or longer to switch the user titles or track titles, etc, while in the CD changer mode.

[▶||] button

- Play or pause a CD or DVD.

[RDM] button

- Perform random play. Press and hold the button for 1 second or longer to perform disc random play.

[RPT] button

- Perform repeat play. Press and hold the button for 1 second or longer to perform disc repeat play.

[SCN] button

- Perform scan play for 10 seconds of each track. Press and hold the button for 1 second or longer to perform disc scan play.

[BND] button

- Move the next disc in increasing order.

When the TV is connected

* For details, see the section “**TV Operations**” (page 29).

[◀◀], [▶▶] buttons

- Select a station.

[DIRECT] buttons

- Store a station into memory or recall it directly.

[P] button

- Perform preset scan while in the TV mode.
- Press and hold the button for 2 seconds or longer, auto store is performed.

[A] button

- Press and hold the button for 1 second or longer to switch the TV picture mode or VTR (external) picture mode.

[BND] button

- Switch the band.
- Press and hold the button for 1 second or longer to switch seek tuning or manual mode.

When the iPod is connected

* For details, see the section “**iPod Operations**” (page 31).

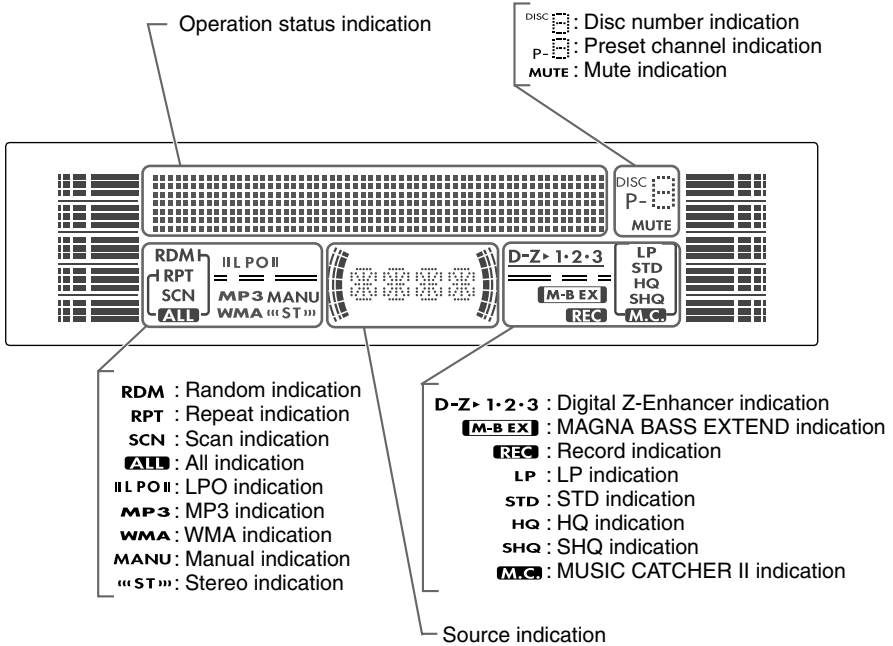

Display Screen

In extreme cold, the screen movement may slow down and the screen may darken, but this is normal. The screen will recover when it returns to normal temperature.

5. REMOTE CONTROL

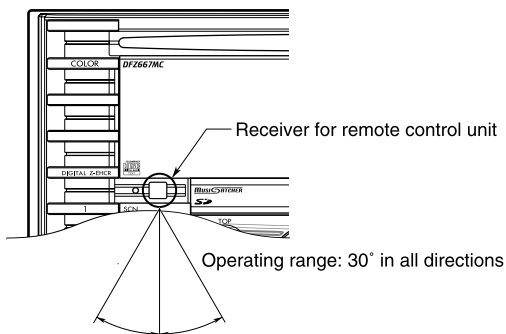

Remote control unit

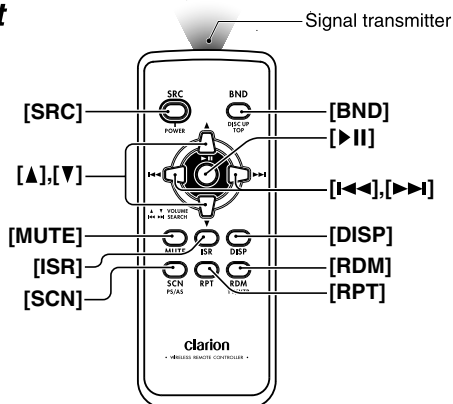

Inserting the Battery

- 1 Turn over the remote control unit and slide the cover in the direction indicated by the arrow in the illustration.
- 2 Insert the battery (CR2025) into the insertion guides, with the printed side (+) facing upwards.
- 3 Press the battery in the direction indicated by the arrow so that it slides into the compartment.
- 4 Replace the cover and slide in until it clicks into place.

- Do not subject battery to heat, or dispose of in fire or water. Do not attempt to disassemble the battery.
- Dispose of used batteries properly.

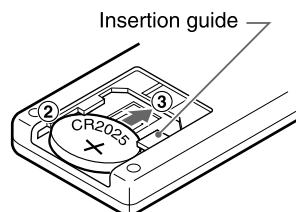
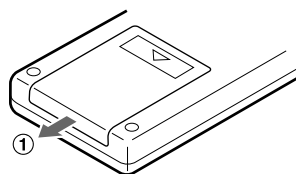

Notes:

Misuse may result in rupture of the battery, producing leakage of fluid and resulting in personal injury or damage to surrounding materials. Always follow these safety precautions:

- Use only the designated battery.
- When replacing the battery, insert properly, with +/- polarities oriented correctly.

Functions of Remote Control Unit Buttons

	Mode			
	Radio	CD/MP3/WMA M.CATCHER/SD	CD changer/ DVD changer	TV
[SRC]	Switch among radio, CD/MP3/WMA, MC, SD, CD changer, DVD changer, TV and AUX			
[BND]	Switch reception band	Play the first track Top play	Move the next disc in increasing order	Switch reception band
[▲] , [▼]	Increase and decrease volume (in all modes)			
[◀◀] , [▶▶]	Move preset channels up and down	Move tracks up and down Press and hold the button for 1 second or longer to perform fast-forward/fast-rewind		Move preset channels up and down
[▶]	No function	Switch between playback and pause		No function
[MUTE]	Turn mute on and off			
[ISR]	Recall ISR radio station in memory Press and hold the button for 2 seconds or longer to store current station into ISR memory (radio mode only)			
[DISP]	Switch the display indication			
[SCN]	Preset scan Press and hold the button for 2 seconds or longer to perform Auto store	Scan play Press and hold the button for 1 second or longer to perform folder Scan play while in the MP3/WMA disc, MC, SD mode	Scan play Press and hold the button for 1 second or longer to perform Disc scan play	Preset scan Press and hold the button for 2 seconds or longer to perform Auto store
[RPT]	No function	Repeat play Press and hold the button for 1 second or longer to perform folder Repeat play while in the MP3/WMA disc, MC, SD mode	Repeat play Press and hold the button for 1 second or longer to perform Disc repeat play	No function
[RDM]	No function	Random play Press and hold the button for 1 second or longer to perform folder Random play while in the MP3/WMA disc, MC, SD mode	Random play Press and hold the button for 1 second or longer to perform Disc random play	Switch between TV and VTR

* Some of the corresponding buttons on the main unit and remote control unit have different functions.

6. OPERATIONS

Basic Operations

Notes: Be sure to read this chapter referring to the front diagrams of chapter "3. CONTROLS" on page 5 (unfold).

⚠ CAUTION

Be sure to lower the volume before switching off the unit power or the ignition key. The unit remembers its last volume setting. If you switch the power off with the volume up, when you switch the power back on, the sudden loud volume may hurt your hearing and damage the unit.

Turning on/off the power

Notes:

- Be careful about using this unit for a long time without running the engine. If you drain the car's battery too far, you may not be able to start the engine and this can reduce the service life of the battery.

1. Press the [SRC] button.
2. The illumination and display on the unit light up. The unit automatically remembers its last operation mode and will automatically switch to display that mode.
3. Press and hold the [SRC] button for 1 second or longer to turn off the power for the unit.

Notes:

- When turning on for the first time after connected correctly, this unit automatically starts system check and "SYSTEM CHK" appears in the display. When completed, the unit turns its power off automatically. Then, press the [SRC] button.

Selecting a mode

1. Press the [SRC] button to change the operation mode.
2. Each time you press the [SRC] button, the operation mode changes in the following order:
Radio mode → CD/MP3/WMA mode → M.CATCHER mode → SD mode → (iPod mode) → (CD changer mode) → (DVD changer mode) → (TV mode) → AUX mode → Radio mode...
* External equipment not connected with CeNET is not displayed.

Adjusting the volume

1. Turn the [ROTARY] knob clockwise to increase the volume; turning it counterclockwise decreases the volume.
* The volume level is from 0 (minimum) to 33 (maximum).

Switching the display

1. Press the [D] button to select the desired display.
2. Each time you press the [D] button, the display switches in the following order:
Main display → Title display → Clock display → Main display...
* Once selected, the preferred display becomes the display default. When a function adjustment such as volume is made, the screen will momentarily switch to that function's display, then revert back to the preferred display several seconds after the adjustment.
* When you have entered a title, it appears in the title display. If you have not entered a title, "NO TITLE" appears in the title display instead. For details on how to enter a title, refer to the subsection "Entering titles" (page 23) in the section "Common Operations".

Setting MAGNA BASS EXTEND

The MAGNA BASS EXTEND does not adjust the low sound area like the normal sound adjustment function, but emphasizes the deep bass sound area to provide you with a dynamic sound.

- * The factory default setting is off.
1. Press and hold the [A-M] button for 1 second or longer to turn on the MAGNA BASS EXTEND effect. "M-B EX" lights in the display.
 2. Press and hold the [A-M] button for 1 second or longer to turn off the MAGNA BASS EXTEND effect. "M-B EX" goes off from the display.

Notes:

- When "DZE-1", "DZE-2" or "DZE-3" is selected for DZE (Digital Z-Enhancer), setting of MAGNA BASS EXTEND cannot be performed.

Basic Operations

Setting the DZE (Digital Z-Enhancer)

This unit is provided with 3 types of sound tone effects stored in memory. Select the one you prefer.

* The factory default setting is "DZE-OFF".

Each time you press the [DIGITAL Z-EHCR] button, the tone effect changes in the following order:

"DZE-1" → "DZE-2" → "DZE-3" → "DZE-OFF" → "DZE-1"...

- "DZE-1" : suitable for the coaxial speakers
- "DZE-2" : suitable for separate speakers
- "DZE-3" : moderate effect compared to "DZE-1", "DZE-2"
- "DZE-OFF" : no sound effect

Notes:

- The volume changes each time the DZE setting is switched.
- Sufficient effects cannot be obtained with some speaker systems. In such cases, adjust the volume.

Adjusting the tone

1. Press the [A-M] button and select the item to adjust.

2. Each time you press the [A-M] button, the item changes as following order:

● When "DZE-1", "DZE-2" or "DZE-3" is set
"LPO" → "DZE LEVEL" → "BALANCE" → "FADER" → Last function mode...

● When "DZE-OFF" is set
"LPO" → "BASS" → "TREBLE" → "BALANCE" → "FADER" → Last function mode...

Notes:

- The display automatically returns to the previous mode.

Adjusting the LPO (Listening Position Optimizer)

This is the function that virtually optimizes the speaker distances of each type of a car to the listening position, which realizes the clearer soundstage.

The setting value has to be adjusted to the listening position and the type of your car.

* The factory default setting is "TYPE OFF".

1. Press the [A-M] button and select "LPO".

2. Turn the [ROTARY] knob to select the car type. The adjustment options you can select are as follows:

- "TYPE OFF" : no car type selected
- "TYPE CMPCT" : suitable for compact car
- "TYPE SEDAN" : suitable for sedan
- "TYPE 1BOX" : suitable for van

3. Press the [◀◀] or [▶▶] button.

4. Turn the [ROTARY] knob to select seat position. The adjustment items you can select as follows:

- "SEAT F-L" : front left seat
- "SEAT F-R" : front right seat
- "SEAT REAR" : rear seats

* The factory default setting is "SEAT F-L".

5. When the adjustment is complete, press the [A-M] button several times until the function mode is reached.

Adjusting the DZE level

You can adjust the DZE level in 3 steps and register each adjustment respectively.

This adjustment can only be performed when the DZE is set to "DZE-1", "DZE-2" or "DZE-3".

* The factory default setting is "0"
(Adjustment range: -3 to +3).

1. Press the [A-M] button and select "DZE LEVEL".

2. Turn the [ROTARY] knob to adjust the level.

3. When the adjustment is complete, press the [A-M] button several times until the function mode is reached.

Adjusting the bass (Gain, Frequency, Q-curve)

This adjustment can be performed when the DZE is set to "DZE-OFF".

1. Press the [A-M] button and select "BASS".

2. Turn the [ROTARY] knob clockwise to emphasize the bass; turning it counterclockwise attenuates the bass.

* The factory default setting is "B<GAIN 0>"
(Adjustment range: -6 to +8).

3. Press the [◀◀] or [▶▶] button to select "B<FREQ 50>".

Turn the [ROTARY] knob and select the frequency.

* The factory default setting is "B<FREQ 50>"
(Adjustment options: 50/80/120 Hz).

4. Press the [◀◀] or [▶▶] button to select "B<Q 1.00>".

Turning the [ROTARY] knob and select the Q-curve.

* The factory default setting is "B<Q 1.00>"
(Adjustment options: 1.00/1.25/1.50/2.00).

5. When the adjustment is complete, press the [A-M] button several times until the function mode is reached.

Basic Operations

Adjusting the treble (Gain, Frequency)

This adjustment can be performed when the DZE is set to "DZE-OFF".

1. Press the [A-M] button and select "TREBLE".
2. Turn the [ROTARY] knob clockwise to emphasize the treble; turning it counterclockwise attenuates the treble.
 - * The factory default setting is "T<GAIN 0>" (Adjustment range: -6 to +6).
3. Press the [◀◀] or [▶▶] button to select "T<FREQ 12k>". Turn the [ROTARY] knob and select the frequency.
 - * The factory default setting is "T<FREQ 12k>" (Adjustment options: 8 kHz/12 kHz).
4. When the adjustment is complete, press the [A-M] button several times until the function mode is reached.

Adjusting the balance

1. Press the [A-M] button and select "BALANCE".
2. Turn the [ROTARY] knob clockwise to emphasize the sound from the right speaker; turning it counterclockwise emphasizes the sound from the left speaker.
 - * The factory default setting is "BAL 0" (Adjustment range: L13 to R13).
3. When the adjustment is complete, press the [A-M] button several times until the function mode is reached.

Adjusting the fader

1. Press the [A-M] button and select "FADER".
2. Turn the [ROTARY] knob clockwise to emphasize the sound from the front speakers; turning it counterclockwise emphasizes the sound from the rear speakers.
 - * The factory default setting is "FADER 0" (Adjustment range: F12 to R12).
3. When the adjustment is complete, press the [A-M] button several times until the function mode is reached.

Setting the button illumination

1. Press the [COLOR] button to select a color type.
2. Each time you press the [COLOR] button, the type changes in the following order:
 "COLOR SCAN" → "Indigo Blue" → "Surf Blue" → "Silky White" → "Aqua Green" → "Fresh Green" → "Leaf Green" → "Warm Amber" → "Passion Red" → "Vivid Pink" → "Pale Pink" → "Dark Violet" → "Pure Purple" → "USER 1" → "USER 2" → "USER 3" → "COLOR SCAN"...

● Setting COLOR SCAN mode

As selecting "COLOR SCAN", the color automatically changes.

- * The factory default setting is "COLOR SCAN".
- * After 3 second the color changes to the other.

● Setting USER mode

As selecting "USER", press and hold the [COLOR] button for 1 second or longer, "R>8 G>8 B>8" appears in the display.

- * The factory default setting is "R>8 G>8 B>8".

1. Press the [◀◀] or [▶▶] button to move the cursor.
2. Turn the [ROTARY] knob and select from 0 to 8.
3. Press and hold the [P] button for 2 seconds or longer to store the color in memory and cancel setting mode.

COLOR	R	G	B
Indigo Blue	0	0	8
Surf Blue	0	4	8
Silky White	8	8	7
Aqua Green	0	8	2
Fresh Green	0	8	0
Leaf Green	3	8	0
Warm Amber	8	3	0
Passion Red	8	0	0
Vivid Pink	8	0	3
Pale Pink	8	2	3
Dark Violet	3	0	8
Pure Purple	6	0	8
USER 1	8	8	8
USER 2	8	8	8
USER 3	8	8	8

Radio Operations

Listening to the radio

1. Press the [SRC] button and select the radio mode. The frequency appears in the display.
2. Press the [BND] button and select the radio band. Each time the button is pressed, the radio reception band changes in the following order:
“FM1” → “FM2” → “FM3” → “AM” → “FM1”...
3. Press the [◀◀] or [▶▶] button to tune in the desired station.

Tuning

There are 3 types of tuning mode available, seek tuning, manual tuning and preset tuning.

Seek tuning

1. Press the [BND] button and select the desired band (FM or AM).
 - * If “MANU” is lit in the display, press and hold the [BND] button for 1 second or longer. “MANU” in the display goes off and seek tuning is now available.
2. Press the [◀◀] or [▶▶] button to automatically seek a station.
When the [▶▶] button is pressed, the station is sought in the direction of higher frequencies; if the [◀◀] button is pressed, the station is sought in the direction of lower frequencies.

Manual tuning

There are 2 ways available: Quick tuning and step tuning.

When you are in the step tuning mode, the frequency changes one step at a time. In the quick tuning mode, you can quickly tune the desired frequency.

1. Press the [BND] button and select the desired band (FM or AM).
 - * If “MANU” is not lit in the display, press and hold the [BND] button for 1 second or longer. “MANU” is lit in the display and manual tuning is now available.
2. Tune into a station.

● Quick tuning:

1. Press and hold the [◀◀] or [▶▶] button for 1 second or longer to tune in a station.

● Step tuning:

1. Press the [◀◀] or [▶▶] button to manually tune in a station.

Recalling a preset station

A total of 24 preset positions (6-FM1, 6-FM2, 6-FM3, 6-AM) exists to store individual radio stations in memory. Pressing the corresponding [DIRECT] button recalls the stored radio frequency automatically.

1. Press the [BND] button and select the desired band (FM or AM).
2. Press the corresponding [DIRECT] button to recall the stored station.

Notes:

- Be careful not to press and hold one of the [DIRECT] buttons for 2 seconds or longer, otherwise the unit starts storing that station into preset memory.

Manual memory

1. Select the desired station with seek tuning, manual tuning or preset tuning.
2. Press and hold one of the [DIRECT] buttons for 2 seconds or longer to store the current station into preset memory.

Auto store

Auto store is a function for storing up to 6 stations that are automatically tuned in sequentially. If 6 receivable stations cannot be received, a previously stored station remains unoverwritten at the memory position.

1. Press the [BND] button and select the desired band (FM or AM).
2. Press and hold the [▶] button for 2 seconds or longer. The stations with good reception are stored automatically to the preset channels.

Preset scan

Preset scan receives the stations stored in preset memory in order. This function is useful when searching for a desired station in memory.

1. Press the [▶] button.
2. When a desired station is tuned in, press the [▶] button again to continue receiving that station.

Notes:

- Be careful not to press and hold the [▶] button for 2 seconds or longer, otherwise the auto store function is engaged and the unit starts storing stations.

Instant station recall (ISR)

Instant station recall is a special radio preset that instantly accesses a favorite radio station at a touch of a button. The ISR function even operates with the unit in other modes.

● **ISR memory**

1. Select the station that you wish to store in ISR memory.
2. Press and hold the **[ISR]** button for 2 seconds or longer.

● **Recalling a station with ISR**

In any mode, the **[ISR]** button turns on the radio function and tune the selected radio station. "ISR" appears in the display. Press the **[ISR]** button again to return to the previous mode.

CD/MP3/WMA, SD memory card, and MUSIC CATCHER II (Playing) Operations

Playing Operations

You can play back CD tracks, MP3/WMA type tracks, and tracks on SD memory card or stored in MUSIC CATCHER II memory with the same operations.

MP3/WMA

What is MP3?

MP3 is an audio compression method and classified into audio layer 3 of MPEG standards. This audio compression method has penetrated into PC users and become a standard format. This MP3 features the original audio data compression to about 10 percent of its initial size with a high sound quality. This means that about 10 music CDs can be recorded on a CD-R disc or CD-RW disc to allow a long listening time without having to change CDs.

What is WMA?

WMA is the abbreviation of Windows Media Audio, an audio file format developed by Microsoft Corporation.

Notes:

- If you play a file with DRM (Digital Rights Management) for WMA remaining ON, no audio is output (“**The WMA indicator**” blinks).
- Windows Media™, and the Windows® logo are trademarks, or registered trademarks of Microsoft Corporation in the United States and/or other countries.

●To disable DRM (Digital Rights Management):

1. When using Windows Media Player 9, click on TOOL → OPTIONS → MUSIC RECORD tab, then under Recording settings, unclick the Check box for RECORD PROTECTED MUSIC. Then, reconstruct files. Personally constructed WMA files are used at your own responsibility.
2. When using Windows Media Player 10, click on TOOLS → OPTIONS → RIP MUSIC tab, then under RIP SETTINGS, unclick the Check box for COPY PROTECT MUSIC. Then, reconstruct files. Personally constructed WMA files are used at your own responsibility.

Precautions when creating MP3/WMA files

●Usable sampling rates and bit rates:

- MP3: Sampling rate 11.025 kHz-48 kHz, Bit rate: 8 kbps-320 kbps / VBR
- WMA: Bit rate 48 kbps-192 kbps

●File extensions

- Always add a file extension “.MP3” or “.WMA” to MP3 or WMA file by using single byte letters. If you add a file extension other than specified or forget to add the file extension, the file cannot be played.
- Files without MP3/WMA data will not play. The indication “--:--” appears in the play time display if you attempt to play files without MP3/WMA data.

●Logical format (File system)

- When writing MP3/WMA file on a CD-R disc or CD-RW disc, please select “**ISO9660 level 1, 2 or JOLIET or Romeo**” as the writing software format. Normal play may not be possible if the disc is recorded on another format.
- Be sure to format SD memory card as FAT12, FAT16, FAT32 or VFAT (SD memory card standard compliant format).
- For this equipment, SD memory card capacity range is as follows: 32 Mbyte to 1 Gbyte
- For this equipment, SD memory card compatible file format is MP3 and WMA.
- The folder name and file name can be displayed as the title during MP3/WMA play but the title must be within 128 single byte alphabetical letters and numerals (including an extension).
- Do not affix a name to a file inside a folder having the same name.

●Folder structure

- A disc with a folder having more than 8 hierarchical levels will be impossible.
- SD memory card maximum path length is 126 bytes.

Notes:

- This equipment does not support SD audio player.
- This equipment does not support miniSD card and MMC (Multi Media Card) formats.

● Number of files or folders

- Up to 255 files can be recognized per folder.
Up to 512 files can be played.
- Tracks are played in the order that they were recorded onto a disc (Tracks might not always be played in the order displayed on the PC).
- Some noise may occur depending on the type of encoder software used while recording.

Multisession function

When a disc contains both normal CD type tracks and MP3/WMA type tracks mixedly, you can select which type of the recorded tracks to play.

● Default value is "M-SESS CD".

Each time you press and hold the [BND] button for 1 second or longer, the mixed mode is switched between M-SESS CD and M-SESS MP3.

- Types of recording that can be played are as follows:

		Setting	
		Set to M-SESS CD	Set to M-SESS MP3
Disc	Mixed with CD and MP3/WMA type tracks	Play CD	Play MP3/WMA
	CD type track only	Play CD	Play CD
	MP3/WMA type track only	Play MP3/WMA	Play MP3/WMA

- After making these settings, remove the disc and then reinsert it (in case of one disc).

Notes:

- When playing a CCCD (Copy Control CD), set the setting to CD type. When this is set to MP3/WMA type, the CD cannot be played normally in some cases.
- When playing the disc (contains CD tracks and MP3/WMA type tracks), there is no sound for MP3 type tracks if the setting "M-SESS CD" is selected. Press the [◀◀] or [▶▶] button to select another type.



Disc-In-Play function

As long as the ignition key is turned to the ON or ACC position, this function allows you to turn the power to the unit and start playing the disc automatically when the disc is inserted even if the power is not turned on.

Loading a CD or a SD memory card

1. Insert a CD or a SD memory card into the center of the CD SLOT or the SD MEMORY CARD SLOT with the label side facing up. While loading, "FILE READ" appears in the title display; then the CD or the SD memory card plays automatically.

Notes:

- Never insert foreign objects into the CD SLOT or the SD MEMORY CARD SLOT.
- If the CD or the SD memory card is not inserted easily, there may be another CD or SD memory card in the mechanism or the unit may require service.
- Discs not bearing the  or  mark and CD-ROMs cannot be played by this unit.
- Some CDs recorded in CD-R/CD-RW mode may not be usable.

Loading 8 cm compact discs

- * No adapter is required to play an 8 cm CD.
- * Insert the 8 cm CD into the center of the insertion slot.

Backup Eject function

Just pressing the [CD▲] button ejects the disc even if the power to the unit was not turned on.

● CD

1. Press the [CD▲] button and remove it when ejected.

● SD memory card

1. Push the SD memory card and remove it when ejected.

Notes:

- SD memory card may pop out during removal.

▲ CAUTION

- Do not try to put your hand or fingers in the CD SLOT or the SD MEMORY CARD SLOT. Also never insert foreign objects into the slot.
- Do not insert discs or SD memory cards where adhesive comes out from cellophane tape or rental CD label, or discs with marks where cellophane tape or rental CD labels were removed. It may be impossible to extract these discs or SD memory cards from the unit and they may cause the unit to break down.

Listening to a disc or a SD memory card already loaded in the unit

1. Press the [SRC] button to select the CD/MP3/WMA or SD mode.
When the unit enters the CD/MP3/WMA or SD mode, play starts automatically.
 - * If there is no disc or SD memory card loaded, "NO DISC" or "NO SD CARD" appears in the title display.
 - * The mode changes each time the [SRC] button is pressed (Modes are not displayed for equipment that is not connected).

Pausing play

1. Press the [P] button to pause play. "PAUSE" appears in the display.
2. To resume CD play, press the [P] button again.

Displaying titles

This unit can display title data for CD-text/MP3/WMA disc and user titles input with this unit.

1. Press the [D] button to display the title.
2. Each time you press the [TITLE] button, the title display changes in the following order:

● CD-TEXT disc

User title (USER) → CD-text title (DISC) →
Artist name (ARTIST) → CD-text title (TRACK)
→ User title (USER)...

● MP3/WMA disc/SD memory card

Folder name (FOLDER) → File name (TRACK)
→ Album TAG (ALBUM)
→ Artist TAG (ARTIST) → Title TAG (TITLE)
→ Folder name (FOLDER)...

● M.CATCHER

Folder name (FOLDER) ↔ File name (TRACK)

Notes:

- If the CD playing is not a CD-text CD or no user title has been input, "NO TITLE" appears in the display.
- If MP3/WMA disc is not input TAG, "NO TAG" appears in the display.
- For MP3, supports ID3 Tags V2.3 / 2.2 / 1.1 / 1.0.
- Tag displays give priority to V2.3 / 2.2.
- In the case of album Tags for WMA, the information written into the extension header is displayed.
- Only ASCII characters can be displayed in Tags.

Selecting a track

● Track-up

1. Press the [▶▶] button to move ahead to the beginning of the next track.
2. Each time you press the [▶▶] button, the track advances ahead to the beginning of the next track.

● Track-down

1. Press the [◀◀] button to move back to the beginning of the current track.
2. Press the [◀◀] button twice to move to the beginning of the previous track.

Fast-forward/fast-rewind

● Fast-forward

1. Press and hold the [▶▶] button for 1 second or longer.

● Fast-rewind

1. Press and hold the [◀◀] button for 1 second or longer.
 - * For MP3/WMA discs or SD memory cards, it takes some time until the start of searching and between tracks. In addition, the playing time may have a margin of error.

Folder Select

This function allows you to select a folder containing MP3/WMA files and start playing from the first track in the folder.

1. Press the [UP] or [DOWN] button.
Press the [UP] button to move to the next folder.
Press the [DOWN] button to move to the previous folder.
 - * Press the [UP] button while in the final folder to shift to the first folder.
 - * Folder without an MP3/WMA file is not selectable.
2. To select a track, press the [◀◀] or [▶▶] button.

Top function

Return to the first track (track No.1) of the disc or the folder currently being played back, and start playing.

1. Press the [BND] button.
 - * In case of MP3/WMA files, return to the first track of a folder currently being played back.

Scan play

This function allows you to locate and play the first 10 seconds of all the tracks recorded on a CD or a SD memory card.

1. Press the **[SCN]** button.
 - * Scan play starts from the next track after the track currently being played back.
2. To cancel scan play, press the **[SCN]** button again.

Folder scan play

This function allows you to locate and play the first 10 seconds of the first track of all the folders on an MP3/WMA disc or a SD memory card.

1. Press and hold the **[SCN]** button for 1 second or longer.
 - * Folder scan play starts from the next track after the track currently being played back.
2. To cancel folder scan play, press the **[SCN]** button again.

Repeat play

This function allows you to play the current track repeatedly.

1. Press the **[RPT]** button.
2. To cancel repeat play, press the **[RPT]** button again.

Folder repeat play

This function allows you to play a track in the folder currently being played back in the MP3/WMA disc or the SD memory card repeatedly.

1. Press and hold the **[RPT]** button for 1 second or longer.
2. To cancel folder repeat play, press the **[RPT]** button again.

Random play

This function allows you to play all tracks recorded on a CD; and all tracks in the folder (currently being played back in the MP3/WMA disc or the SD memory card) in a random order.

1. Press the **[RDM]** button.
2. To cancel random play, press the **[RDM]** button again.

Folder random play

This function allows you to play all tracks of all the folders recorded on an MP3/WMA disc or a SD memory card in a random order.

1. Press and hold the **[RDM]** button for 1 second or longer.
2. To cancel folder random play, press the **[RDM]** button again.

Notes on recording using MUSIC CATCHER II

- MUSIC CATCHER II provides recording feature at 4 times speed for audio CDs or CD-Rs.
- For CD-RWs, only double-speed recording is available.
- Recording using MUSIC CATCHER II is available only for audio CDs (including CD-R, CD-RW). MP3/WMA discs cannot be recorded; sounds from the AUX input jack or the radio cannot be recorded, too.
- When recording finishes, MUSIC CATCHER II automatically rewinds to the beginning of the track currently being played back. This is caused by the difference between the recording speed and the playing speed; that does not mean mechanical failure.
- The sound quality after the recording may differ from that you heard during the recording. This is caused by that MUSIC CATCHER II uses its memory (just recorded) as the sound source for the playback during recording; that does not mean mechanical failure.
- When you start recording during a CD or a track playback, MUSIC CATCHER II automatically rewinds to the beginning of the CD or the track, then starts recording.
- The sound quality while MUSIC CATCHER II playing back may differ from that of audio CD. If you are not satisfied with the sound quality, switch the recording mode to SHQ, or HQ; and retry recording.
- In recording using MUSIC CATCHER II, some amount of silent time is created between the tracks.
- When recording the rest of the tracks on a CD with some tracks already have been recorded, MUSIC CATCHER II records that rest of the tracks to the same folder previously used.
- Folder and file names are added automatically during recording. These folder and file names cannot be changed (The file names correspond to the track Nos. on the CD).
Example:
Folder name : **FLD00001**
Track name : **TRACK 01**
Set a "**USER TITLE**" for a folder name using the entering titles function. Also, delete the "**USER TITLE**" previously entered, and then MUSIC CATCHER II renames that folder to the same name automatically added during recording. For details on how to set a title, refer to the subsection "**Entering titles**" (page 23) in the section "**Common Operations**".
- If the disc is not recordable, "**NO REC DSC**" shows on the display.
- If the disc contains some tracks previously recorded, "**INCLUDED**" shows on the display.
- If there is no empty folder available, "**FOLDER FULL**" shows on the display.
- When the memory capacity is used up, "**MEMORY FULL**" shows on the display and recording is canceled.
- Recording cannot be performed during SCN, RPT, and RDM. In such cases, "**BUSY**" shows on the display.
- The [▶], [◀◀], [▶▶], [BND] and [SCN/PRT/RDM] buttons are invalid during recording. When these buttons are pressed, "**INVALID**" shows on the display.

Remaining capacity of the memory

Refer to the subsection "**Remaining capacity of the memory**" (page 25) in the section "**Adjust Mode**".

Setting a recording mode

Refer to the subsection "**Setting a recording mode**" (page 25) in the section "**Adjust Mode**".

- "**SHQ**" : about 248 minutes
- "**HQ**" : about 331 minutes
- "**STD**" : about 497 minutes
- "**LP**" : about 663 minutes

MUSIC CATCHER II (Recording/Erasing) Operations

Recording operation (REC function)

Recording using MUSIC CATCHER II is performed in the CD/MP3/WMA mode and the following 2 recording modes are available:

- **“TRACK REC”**: record only one track currently being played back
- **“DISC REC”** : record all tracks on the CD

● TRACK REC

1. Press the [SRC] button to select the CD/MP3/WMA mode.
2. Play back a track to be recorded and press the [REC] button. Then, the “REC” indicator on the display blinks, “TRACK REC” shows on the title display for 2 seconds, and recording starts.
 - * When recording is complete, the “REC” indicator goes off and “REC DONE” shows on the display for 2 seconds.

● DISC REC

1. Press the [SRC] button to select the CD/MP3/WMA mode.
2. Play back a CD to be recorded and press and hold the [REC] button for 2 seconds or longer. Then, the “REC” indicator on the display blinks, “DISC REC” shows on the display for 2 seconds, and recording starts.
 - * When recording is complete, the “REC” indicator goes off and “REC DONE” shows on the display for 2 seconds.

Canceling recording

1. To suspend recording, press the [REC] button again. Then, recording is canceled. The display shows “CANCELED” for 2 seconds and then the playback of the CD continues.

Notes:

- Recording also can be canceled when pressing the [SRC], [CD] or [ISR] button, inserting a SD memory card or a cellular telephone ringing in the car.
- When recording is canceled, the file that has been recorded incompletely is deleted.

Erasing operation (ERASE function)

Erasing recordings made using MUSIC CATCHER II is performed in the M.CATCHER mode and the following 3 erasing modes are available.

- **“FILE ERASE”**: erase only one file.
- **“FLD ERASE”** : erase the whole folder.
- **“ALL ERASE”** : erase all the contents of the flash memory.

1. Press the [SRC] button to select the M.CATCHER mode.
2. Each time you press the [ERASE] button, the display switches in the following order: “FILE ERASE” → “FLD ERASE” → Normal mode

Notes:

- Do not turn off the power to the unit or switch the operation mode during erasing recordings.

● FILE ERASE

1. Press the [SRC] button to select the M.CATCHER mode.
2. Play back a file to be erased, and press the [ERASE] button to select “FILE ERASE”.
3. While “FILE ERASE” is showing on the display, press and hold the [▶] button for 2 seconds or longer. The title display shows “ERASING” as the file currently being played back is erased.

● FOLDER ERASE

1. Press the [SRC] button to select the M.CATCHER mode.
2. Play back any track of the folder to be erased, and press the [ERASE] button to select “FLD ERASE”.
3. While “FLD ERASE” is showing on the display, press and hold the [▶] button for 2 seconds or longer. The title display shows “ERASING” as the folder currently being played back is erased.

● ALL ERASE

1. Press the [SRC] button to select the M.CATCHER mode.
2. Press the [ERASE] button for 2 seconds or longer to select “ALL ERASE”.
3. While “ALL ERASE” is showing on the display, press and hold the [▶] button for 2 seconds or longer. The title display shows “ERASING” as ALL ERASE is executed.

Common Operations

CATS function (Clarion Anti-Theft System)

This unit can deter theft by checking registered optional PIN (Personal Identification Number).

How to register/delete PIN

Refer to the subsection "How to register/delete PIN" (page 26) in the section "Adjust Mode".

PIN (Personal Identification Number) check in the CATS Mode

When the main power source is unconnected for battery exchange, etc, while the CATS mode is on, input your PIN.

1. Press the [DIRECT] buttons to input your PIN in 4 digits.

⚠ CAUTION

- If you input your PIN wrongly, "LOCK----" is to be displayed and CATS lock mode is to be entered. You cannot perform any operation for a given period while in the CATS lock mode.
If your mistakes are less than 6 times, the locking time will be for 15 seconds; if more than 7 times, it will be for 15 minutes.
- If you forget your PIN and enter a wrong PIN, you cannot perform any further operation.

Title function

Entering titles

Titles up to 10 characters long can be stored in memory and displayed for CD, MC, CD changer and Radio/TV stations. The number of titles that can be entered for each mode are as follows.

Mode	Number of titles
Radio mode	30 titles
CD mode	50 titles
TV mode	20 titles
CD changer mode	100 titles

1. Press the [SRC] button to select the mode you want to enter a title (Radio, CD, MC, CD changer or TV).
2. Select and play a file in CD/MC/CD changer or tune in to a Radio/TV station for which you want to enter the title.

3. Press the [D] button and display the title.
 - * While in the CD mode or CD changer mode, press the [TITLE] button to switch to "USER". While in the MC mode, press the [TITLE] button to switch to "FOLDER".
4. Press and hold the [TITLE] button for 1 second or longer.
5. Press the [◀◀] or [▶▶] button to move the cursor.
6. Press the [BND] button to select a character. Each time you press the [BND] button, the character changes in the following order: Capital letters → Small letters → Numbers and Symbols → Umlaut → Capital letters...
7. Turn the [ROTARY] knob to select the desired character.
8. Repeat steps 5 to 7 to enter up to 10 characters for the title.
9. Press and hold the [P] button for 2 seconds or longer to store the title into memory and cancel title input mode.

Clearing titles

1. Select and play a file in CD/MC/CD changer or tune in to a Radio/TV station for which you want to clear the title.
2. Press the [D] button and display the title.
3. Press and hold the [TITLE] button for 1 second or longer to switch to the title input mode.
4. Press and hold the [BND] button for 1 second or longer.
5. Press and hold the [P] button for 2 seconds or longer to clear the title and cancel title input mode.

Display Adjust Mode

Setting the clock

1. Press and hold the [D] button for 1 second or longer to switch to the adjust mode.
2. Press the [◀◀] or [▶▶] button to select "CLOCK .
3. Press the [P1] button.
4. Press the [◀◀] or [▶▶] button to select the hour or the minute.
5. Turn the [ROTARY] knob and set the correct time.
 - * The clock is displayed in 12-hour format.
6. Press the [P1] button to store the time into memory.
7. Press the [D] button to return to the previous mode.

Notes:

- You cannot set the clock when it is displayed with only the ignition on. If you drain or remove the car's battery or take out this unit, the clock is reset. While setting the clock, if another button or operation is selected, the clock set mode is canceled.

Turning the screen saver function on or off

This unit is provided with the screen saver function which allows you to show various kinds of patterns and characters in the Operation Status indication area of the display. You can turn on and off this function.

If the button operation is performed with the screen saver function on, the operation display corresponding to the button operation is shown for about 30 seconds and the display returns to the screen saver display.

* The factory default setting is "ON".

1. Press and hold the [D] button for 1 second or longer to switch to the adjust mode.
2. Press the [◀◀] or [▶▶] button to select "SCRN SVR".
3. Turn the [ROTARY] knob and select "SS OFF", "SS ON" or "SS MESSAGE".
4. Press the [D] button to return to the previous mode.

Entering MESSAGE INFORMATION

When the use of the message is selected for the screen saver setting, you can change the contents of the message.

* Up to 30 characters can be entered.

* The factory default setting is "Welcome to Clarion".

1. Press and hold the [D] button for 1 second or longer to switch to the adjust mode.
2. Press the [◀◀] or [▶▶] button to select "MSG INPUT .
3. Press the [P1] button.
4. Press the [◀◀] or [▶▶] button to move the cursor.
5. Press the [BND] button to select a character. Each time you press the [BND] button, the character changes in the following orders: Capital letters → Small letters → Numbers and Symbols → Umlaut → Capital letters...
6. Turn the [ROTARY] knob to select the desired character.
7. Repeat step 4 to 6 to enter up to 30 characters for message.
8. Press and hold the [P1] button for 2 seconds or longer to store the message in memory and cancel input message mode.
 - * Press and hold the [BND] button for 1 second or longer can cancel the input message. Then press and hold the [P1] button for 2 seconds or longer to store the message and the message return to default setting.
9. Press the [D] button to return to the previous mode.

Setting the method for title scroll

Set how to scroll in CD-TEXT, MP3/WMA TITLE.

* The factory default setting is "ON".

1. Press and hold the [D] button for 1 second or longer to switch to the adjust mode.
2. Press the [◀◀] or [▶▶] button to select "AUTO SCRL".
3. Turn the [ROTARY] knob and select "SCROLL ON" or "SCROLL OFF".
 - **SCROLL ON:**
Scroll automatically.
 - **SCROLL OFF:**
Scroll just 1 time when the title was changed or the [TITLE] button was pressed.
4. Press the [D] button to return to the previous mode.

Common Operations

Setting for scroll speed

You can adjust scroll speed between SPEED 1 (maximum) and SPEED 6 (minimum).

* The factory default setting is "SPEED 2".

1. Press and hold the [D] button for 1 second or longer to switch to the adjust mode.
2. Press the [I◀◀] or [▶▶I] button to select "SCRL SPEED".
3. Turn the [ROTARY] knob and select scroll speed.
4. Press the [D] button to return to the previous mode.

Dimmer control

You can setting the dimmer control ON or OFF.

* The factory default setting is "ON".

1. Press and hold the [D] button for 1 second or longer to switch to the adjust mode.
2. Press the [I◀◀] or [▶▶I] button to select "DIMMER".
3. Turn the [ROTARY] knob and select "DIMMER ON" or "DIMMER OFF".
4. Press the [D] button to return to the previous mode.

Adjusting the display contrast

You can adjust the display contrast to match the angle of installation of the unit.

* The factory default setting is "5".
(Adjustment range: 1 to 16)

1. Press and hold the [D] button for 1 second or longer to switch to the adjust mode.
2. Press the [I◀◀] or [▶▶I] button to select "CONTRAST".
3. Turn the [ROTARY] knob to adjust the contrast.
4. Press the [D] button to return to the previous mode.

Adjust Mode

Remaining capacity of the memory

The remaining capacity of the flash memory can be displayed as an approximate recordable time in "MM : SS" (minute : second).

1. Press the [A] button to switch to the adjust mode.
2. Press the [I◀◀] or [▶▶I] button to select "MC AVIL ☐".
3. Press the [▶i] button.
4. Press the [A] button to return to the previous mode.

Setting a recording mode

The recording mode for MUSIC CATCHER II can be switched between the following 4 modes:

- "SHQ" : about 248 minutes
- "HQ" : about 331 minutes
- "STD" : about 497 minutes
- "LP" : about 663 minutes

* The factory default setting is "STD".

1. Press the [A] button to switch to the adjust mode.
2. Press the [I◀◀] or [▶▶I] button to select "MC-REC".
3. Turn the [ROTARY] knob and select "SHQ", "HQ", "STD" or "LP".
4. Press the [A] button to return to the previous mode.

Anti-theft indicator

When the ignition key is turned to Off, Red Anti-theft indicator blinks to prevent theft by its luminous effect.

* The factory default setting is "OFF".

1. Press the [A] button to switch to the adjust mode.
2. Press the [I◀◀] or [▶▶I] button to select "BLINK LED".
3. Turn the [ROTARY] knob and select "LED ON" or "LED OFF".
4. Press the [A] button to return to the previous mode.

Common Operations

Setting the TV area

When you select the TV area (TV reception area), the TV tuner area setting changes.

1. Press the [A] button to switch to the adjust mode.
2. Press the [◀◀] or [▶▶] button to select "TV AREA ▢".
3. Press the [P1] button.
4. Turn the [ROTARY] knob and select the reception area.
5. Press the [P1] button.
6. Press the [A] button to return to the previous mode.

* The above operations are required when a TV tuner other than TTX7501z is connected.

Setting the TV diver

You can change the reception setting for the TV antenna connected to the TV tuner.

1. Press the [A] button to switch to the adjust mode.
2. Press the [◀◀] or [▶▶] button to select "TV DIVER".
3. Turn the [ROTARY] knob and select "ON" or "OFF".

● **ON:**

Set the diver setting to ON.

● **OFF:**

Set the diver setting to OFF.

4. Press the [A] button to return to the previous mode.

Selecting AUX IN sensitivity

Make the following settings to select the sensitivity when sounds from external devices connected to this unit are difficult to hear even after adjusting the volume.

* The factory default setting is "MID".

1. Press the [A] button to switch to the adjust mode.
2. Press the [◀◀] or [▶▶] button to select "AUX SENSE".
3. Turn the [ROTARY] knob and select "AUX LOW", "AUX MID" or "AUX HIGH".
4. Press the [A] button to return to the previous mode.

How to register/delete PIN

1. Press the [A] button to switch to the adjust mode.
2. Press the [◀◀] or [▶▶] button to select "CODE ▢".

3. Press the [P1] button.
 - * When registering: "ETRY 0000" appears.
 - * When deleting: "DEL 0000" appears.
4. Press the [DIRECT] buttons to input optional PIN in 4 digits.

⚠ CAUTION

- **Establish your PIN by combining numbers from 1 to 6 as you like in 4 digits. Do not forget your PIN, for you cannot perform any further operation without your PIN when you remove the battery for repair, etc.**
- **Write down your PIN for the future use.**

5. Press and hold the [P1] button for 2 seconds or longer to enter the PIN.

Notes:

- *When registering PIN is completed, the unit enters the CATS mode.*

If you input wrong number when deleting your PIN, you cannot complete the operation. In that case, the unit requests you to input the correct PIN.

6. Press the [A] button to return to the previous mode.

Performing a system check

This function verifies the devices connect through CeNET.

1. Press the [A] button to switch to the adjust mode.
2. Press the [◀◀] or [▶▶] button to select "SYS CHECK ▢".
3. Press and hold the [P1] button for 1 second or longer to start the system check.

Triggered audio mute for cellular telephones

This unit requires special wiring to mute the audio signal automatically when a cellular telephone rings in the car.

- * This function is not compatible with all cellular telephones. Contact your local authorized Clarion dealer for information on proper installation and compatibility.

AUX function

This system has an external input jack so you can listen to sounds and music from external devices connected to this unit.

7. OPERATIONS OF ACCESSORIES

CD Changer Operations

CD changer functions

When an optional CD changer is connected through the CeNET cable, this unit controls all CD changer functions. This unit can control a total of 2 changers.

1. Press the [SRC] button and select the CD changer mode to start play.
 - * If 2 CD changers are connected, press the [SRC] button to select the CD changer for play.
 - * If "NO MAG" appears in the display, insert the magazine into the CD changer. "DISC CHECK" appears in the display while the player loads (checks) the magazine.
 - * If "NO DISC" appears in the display, eject the magazine and insert discs into each slot. Then, reinsert the magazine back into the CD changer.

Notes:

- Some CDs recorded in CD-R/CD-RW mode may not be usable.

⚠ CAUTION

CD-ROM discs cannot be played from every CD changer, it's depended on the model.

Pausing play

1. Press the [⏸] button to pause play. "PAUSE" appears in the display.
2. To resume play, press the [▶] button again.

Selecting a track

●Track-up

1. Press the [▶▶] button to move ahead to the beginning of the next track.
2. Each time you press the [▶▶] button, the track advances ahead to the beginning of the next track.

●Track-down

1. Press the [◀◀] button to move back to the beginning of the current track.
2. Press the [◀◀] button twice to move to the beginning of the previous track.

Fast-forward/fast-rewind

●Fast-forward

1. Press and hold the [▶▶] button for 1 second or longer.

●Fast-rewind

1. Press and hold the [◀◀] button for 1 second or longer.

Selecting a CD

1. Press the [UP] or [DOWN] button to select the desired disc.
 - * If a CD is not loaded in a slot of magazine, pressing the [UP] or [DOWN] button can not work.
1. Press the [BND] button to move the next disk in increasing order.

Scan play

Scan play locates and plays the first 10 seconds of each track on a disc automatically. This function continues on the disc until it is cancelled.

1. Press the [SCN] button to start track scanning.
 - * Scan play starts from the next track after the track currently being played back.
2. To cancel the scan play, press the [SCN] button again.

Disc scan play

Disc scan play locates and plays the first 10 seconds of the first track on each disc in the currently selected CD changer. This function continues automatically until it is cancelled.

1. Press and hold the [SCN] button for 1 second or longer.
 - * Disc scan play starts from the next track after the track currently being played back.
2. To cancel disc scan play, press the [SCN] button again.

Repeat play

Repeat play continuously plays the current track. This function continues automatically until it is cancelled.

1. Press the [RPT] button.
2. To cancel repeat play, press the [RPT] button again.

Disc repeat play

After all the tracks on the current disc have been played, disc repeat play automatically replays the current disc over from the first track. This function continues automatically until it is cancelled.

1. Press and hold the **[RPT]** button for 1 second or longer.
2. To cancel disc repeat play, press the **[RPT]** button again.

Random play

Random play selects and plays individual tracks on the disc in no particular order. This function continues automatically until it is cancelled.

1. Press the **[RDM]** button.
2. To cancel random play, press the **[RDM]** button again.

Disc random play

The disc random play selects and plays individual tracks or discs automatically in no particular order. This function continues automatically until it is cancelled.

1. Press and hold the **[RDM]** button for 1 second or longer.
2. To cancel disc random play, press the **[RDM]** button again.

TV tuner functions

When an optional TV tuner is connected through the CeNET cable, this unit controls all TV tuner functions. To watch TV requires a TV tuner and monitor.

Watching a TV

1. Press the **[SRC]** button and select the TV mode.
2. Press the **[BND]** button to select the desired TV band (TV1 or TV2). Each time the button is pressed, the input selection toggles between TV1 and TV2.
3. Press the **[◀▶]** or **[▶▶]** button to tune in the desired TV station.

Watching a video

The TV tuner has a VTR input terminal to which 1 external device can be connected. Connect a 12 V video cassette player (VCP) or video cassette recorder (VCR) to the TV tuner input terminal.

1. Press and hold the **[A]** button for 1 second or longer to select VTR.
2. To return to the TV broadcast, press and hold the **[A]** button for 1 second or longer.

Tuning

There are 3 types of tuning mode available, seek tuning, manual tuning and preset tuning.

Seek tuning

1. Press the **[BND]** button and select the desired TV band (TV1 or TV2).
 - * If **"MANU"** is lit in the display, press and hold the **[BND]** button for 1 second or longer. **"MANU"** in the display goes off and seek tuning is now available.
2. Press the **[◀▶]** or **[▶▶]** button to automatically seek a station. Press the **[▶▶]** button to automatically tune up the frequency band to the next available TV station; press the **[◀▶]** button to automatically tune down.

Manual tuning

There are 2 ways available: Quick tuning and step tuning.

When you are in the step tuning mode, the frequency changes one step at a time. In the quick tuning mode, you can quickly tune the desired frequency.

1. Press the **[BND]** button and select the desired band (TV1 or TV2).
 - * If **"MANU"** is not lit in the display, press and hold the **[BND]** button for 1 second or longer. **"MANU"** lights in the display and manual tuning is now available.
2. Tune into a station.
 - **Quick tuning:**
 1. Press and hold the **[◀▶]** or **[▶▶]** button for 1 second or longer to tune in a station.
 - **Step tuning:**
 1. Press the **[◀▶]** or **[▶▶]** button to manually tune in a station.

Recalling a preset station

A total of 12 TV stations can be stored (6-TV1 and 6-TV2). This allows you to select your favorite TV stations and store them in memory for later recall.

1. Press the **[BND]** button and select the desired TV band (TV1 or TV2).
2. To recall a stored TV station, press the desired **[DIRECT]** button to select that station.

Notes:

- Be careful not to press and hold one of the **[DIRECT]** buttons for 2 seconds or longer, otherwise the unit starts storing that station into preset memory.

Manual memory

1. Select the desired station with seek tuning, manual tuning or preset tuning.
2. Press and hold one of **[DIRECT]** buttons for 2 seconds or longer to store the current station into preset memory.

Auto store

Auto store selects 6 TV stations automatically and stores each one into preset memory.

If there are not 6 stations with good reception, stations previously stored in memory remain and only the strong stations are stored into memory.

1. Press the [BND] button and select the desired TV band (TV1 or TV2).
2. Press and hold the [P1] button for 2 seconds or longer. The stations with good reception are stored automatically to the preset channels.

Preset scan

Preset scan allows the user to view each preset position before it automatically advances to the next preset. This function is useful for searching for a desired TV station in memory.

1. Press the [P1] button.
2. When the desired station is found, press the [P1] button again to remain tuned to that station.

Notes:

- *Be careful not to press and hold the [P1] button for 2 seconds or longer, otherwise the auto store function is engaged and the unit starts storing stations.*

Setting the TV area

Refer to the subsection “**Setting the TV area**” (page 26) in the section “**Adjust Mode**”.

Setting the TV diver

Refer to the subsection “**Setting the TV diver**” (page 26) in the section “**Adjust Mode**”.

iPod Operations

iPod functions

Connecting the iPod CeNET Controller allows you to operate your iPod from the operation panel of this unit. This unit has the iPod MENU mode which allows you to operate by the same feeling as operating on the iPod.

In the iPod mode, this system considers all the tracks stored in the iPod as one album when selecting tracks or playing them back. To search tracks by the album title or the artist name by the similar operations from the Music menu of the iPod, refer to the subsection "Selecting tracks in the iPod MENU mode" (page 32) in the section "iPod Operations".

Notes on using iPod

You can connect the following iPods:

- iPod G3 Ver. 2.3 or higher
- iPod G4 Ver. 3.1 or higher
- iPod Photo Ver. 1.2 or higher (Images cannot be displayed)
- iPod mini Ver. 1.4 or higher
- iPod nano Ver. 1.0 or higher

Notes:

- iPod shuffle cannot be connected.
- When the iPod is connected, the operations on the iPod are prohibited.
- The characters that can be displayed are alphanumeric characters only. 2-byte characters cannot be displayed.

Selecting iPod mode

1. Press the [SRC] button to select the iPod mode.

Notes:

- When "NO IPOD" is displayed, check whether the connectors of the iPod and iPod CeNET Controller are correctly connected.

Switching the display

1. Press the [D] button to select the desired display.
2. Each time you press the [D] button, the display switches in the following order:

Number of tracks display

The number of tracks in the Music menu currently played back and the current track number are displayed.

Play time display

The current track number and play time are displayed.

Title display

The album title, artist name and song title of the current track are displayed.

Press the [TITLE] button while the title is displayed switches the title display as follows:

ALBUMS → ARTISTS → SONGS → ALBUMS...

Notes:

- Title characters which cannot be displayed by this unit are displayed with "*".

Pausing play

1. Press the [P] button during playback. The playback is paused.
2. To resume playback, press the [P] button again.

Selecting a track

●Track-up

1. Press the [▶▶] button during playback to move ahead to the beginning of the next track.

●Track-down

1. Press the [◀◀] button during playback to move back to the beginning of the current track.
2. Press the [◀◀] button again within 2 seconds after the beginning of the track to move to the beginning of the previous track.

Fast-forward/fast-rewind

●Fast-forward

1. Press and hold the [▶▶] button for 1 second or longer during playback.

●Fast-rewind

1. Press and hold the [◀◀] button for 1 second or longer during playback.

All play

This plays back all the tracks. It corresponds to the iPod operation of playing back tracks sequentially by selecting "Music" → "Songs" from the menu of the iPod.

1. Press and hold the [BND] button for 1 second or longer. It changes to the ALL PLAY mode, and all the tracks stored in the iPod are played back sequentially.

Repeat play

This repeat playback of the track currently played back. It corresponds to the iPod operation of selecting “**Settings**” → “**Repeat (one)**” from the menu of the iPod.

1. Press the [RPT] button.
2. To cancel the repeat playback, press the [RPT] button again.

All repeat play

This repeat playback of the all tracks. It corresponds to the iPod operation of selecting “**Settings**” → “**Repeat (ALL)**” from the menu of the iPod.

1. Press and hold the [RPT] button for 1 second or longer.
2. To cancel All repeat playback, press the [RPT] button again.

Random play

This specifies random playback of the tracks included in the album. It corresponds to the iPod operation of selecting “**Settings**” → “**Shuffle (Albums)**” from the menu of the iPod.

1. Press the [RDM] button.
2. To cancel the random playback, press the [RDM] button again.

All random play

This specifies random playback of all the tracks. It corresponds to the iPod operation of selecting “**Settings**” → “**Shuffle (Songs)**” from the menu of the iPod.

1. Press and hold the [RDM] button for 1 second or longer.
2. To cancel the All random playback, press the [RDM] button again.

Selecting tracks in the iPod MENU mode

In the iPod mode, you can select tracks by the album title or artist name by the similar operations on the iPod as well as the iPod Music menu.

Notes:

- If you do not operate for 10 seconds or longer after switching to the iPod MENU mode, the iPod MENU mode is canceled, and it changes to the general iPod mode.
- In the iPod MENU mode, you cannot specify the fast-forward, fast-rewind, repeat and random playback.

1. Press the [BND] button in the iPod mode.
2. Turn the [ROTARY] knob to select the menu, then press the [▶▶] button. Or, press either of the [DIRECT] (1 to 6) button.
[DIRECT](1) “P-LISTS”
[DIRECT](2) “ARTISTS”
[DIRECT](3) “ALBUMS”
[DIRECT](4) “SONGS”
[DIRECT](5) “GENRES”
[DIRECT](6) “COMPOSER”
3. Turn the [ROTARY] knob to select the menu, then press the [▶▶] button. Select tracks by repeating this operation.

Notes:

- The number of repeating operation is differ depending to the selected menu.
- To return to the previous list, press the [◀◀] button. However, you cannot return to the menu of the step 2. Perform the operation from the step 1 again.

8. TROUBLE SHOOTING

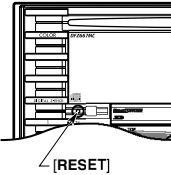
	Problem	Cause	Measure
General	Power does not turn on (No sound is produced)	Fuse is blown	Replace with a fuse of the same amperage If the fuse blows again, consult your store of purchase
		Incorrect wiring	Consult your store of purchase
	No sound output when operating the unit with amplifiers or power antenna attached	Power antenna lead is shorted to ground or excessive current is required for remote-on the amplifiers or power antenna	<ol style="list-style-type: none"> 1. Turn the unit off 2. Remove all wires attached to the power antenna lead Check each wire for a possible short to ground using an ohm meter 3. Turn the unit back on 4. Reconnect each amplifier remote wire to the power antenna lead one by one If the amplifiers turn off before all wires are attached, use an external relay to provide remote-on voltage (excessive current required)
	Nothing happens when buttons are pressed Display is not accurate	The microprocessor has malfunctioned due to noise, etc	Press and hold the [RESET] button for 2 seconds or longer with a thin rod 
"FAIL ****" is displayed	Anti-theft function is out of order	Press and hold the [RESET] button for 2 seconds or longer with a thin rod If the situation is not improved, contact your local authorized Clarion dealer	
CD/MP3/WMA, SD	No sound heard	There is a disc other than a compact disc or foreign matter already in place	Press and hold the [CD▲] button for 3 seconds or longer The foreign matter is forcibly ejected
		MP3/WMA files are absent in a disc or a SD memory card	Write MP3/WMA files onto the disc or the SD memory card properly
		Files are not recognized as an MP3/WMA file	Use MP3/WMA files encoded properly
		File system is not correct	Use ISO9660 level 1, 2 or JOLIET or Romeo file system Format SD memory card as FAT12, FAT16, FAT32 or VFAT
	Sound skips or is noisy	Disc is dirty	Clean the disc with a soft cloth
		Disc is heavily scratched or warped	Replace with a disc with no scratches
Sound is cut or skipped Noise is generated or noise is mixed with sound	MP3/WMA files are not encoded properly	Use MP3/WMA files encoded properly	

	Problem	Cause	Measure
CD/MP3/WMA, SD	Sound is bad directly after power is turned on	Water droplets may form on the internal lens when the car is parked in a humid place	Let dry for about 1 hour with the power on
	Wrong filename	File system is not correct	Use ISO9660 level 1, 2 or JOLIET or Romeo file system Format SD memory card as FAT12, FAT16, FAT32 or VFAT
	Play list play is not performed	File name or extension is not correct	Use alphanumeric/ASCII characters for MP3/WMA file name Use ". M3U " for the file extension of a play list
MC	Cannot record any audio tracks	MP3/WMA disc is currently played back	Only audio CD (CD-DA) can be recorded using MC
		Sound source other than audio CD is currently played back	Switch to CD mode and playback audio CD as the sound source
		SCN, RPT, RDM is turned ON	Cancel Scan play, Repeat play, Random play and record the track
		This track is already recorded in the MC memory	Cannot record the same track already exists in the MC memory Erase the track and record again
		No available folder	Erase the unnecessary folder
		No available memory (the MC memory capacity is full)	Erase the unnecessary folder or file
MC	Move back to the beginning of the track automatically after recording	Sound source switches from the MC memory to audio CD	This is the normal behavior of this product (not mechanical failure)
	Sound is bad	When LP mode, the sound quality may lower relatively (recording time length is the priority condition for LP mode)	Switch to SHQ or HQ mode and record again
	The approximate recordable time does not increase after erasing track	The approximate recordable time is calculated with adequate margin Erasing tracks like short length ones may not be able to increase the approximate recordable time	This is the normal behavior of this product (not mechanical failure)

9. ERROR DISPLAYS

If an error occurs, one of the following displays is displayed.
Take the measures described below to eliminate the problem.

	Error Display	Cause	Measure
CD/MP3/WMA	ERROR 2	A DISC is caught inside the CD deck and is not ejected	This is a failure of CD deck's mechanism and consult your store of purchase
	ERROR 3	A DISC cannot be played due to scratches, etc	Replace with a non-scratched, non-warped-disc
	ERROR 6	A DISC is loaded upside-down inside the CD deck and does not play	Eject the disc then reload it properly
M.CATCHER	ERROR 7	The format of the flash memory is damaged	Execute ALL ERASE on the flash memory, and the problem is solved
	ERROR 8	There is a failure with the flash memory	Turn POWER/ACC off and then turn it on again, and the problem is solved If not solved, executed ALL ERASE on the flash memory, and the problem is solved
	ERROR 9	An error during recording, scratch on the disc, or error due to sound skips	Turn POWER/ACC off and then turn it on again, or eject the CD The problem is solved
SD	ERROR 7	SD memory card format is corrupted	Eject and reinsert several times If the error message persists, format SD memory card as FAT12, FAT16, FAT32 or VFAT
	ERROR 8	DSP Error	Turn POWER/ACC off and then turn it on again, and the problem is solved
CD changer	ERROR 2	A DISC inside the CD changer is not loaded	This is a failure of CD changer's mechanism and consult your store of purchase
	ERROR 3	A DISC inside the CD changer cannot be played due to scratches, etc	Replace with a non-scratched, non-warped disc
	ERROR 6	A DISC inside the CD changer cannot be played because it is loaded upside-down	Eject the disc then reload it properly
DVD changer	ERROR 2	A DISC inside the DVD changer cannot be played	This is a failure of DVD mechanism and consult your store of purchase
	ERROR 3	A DISC cannot be played due to scratches, etc	Retry or replace with a non-scratched, non-warped-disc
	ERROR 6	A DISC inside the DVD changer cannot be played because it is loaded upside-down	Eject the disc then reload it properly
	ERROR P	Parental level error	Set the correct Parental level
	ERROR R	Region code error	Eject the disc and replace correct region code disc

If an error display other than the ones described above appears, press the reset button. If the problem persists, turn off the power and consult your store of purchase.

10. SPECIFICATIONS

FM Tuner

Frequency Range:
87.0 MHz to 108.0 MHz
Usable Sensitivity:
9 dBf
50dB Quieting Sensitivity:
15 dBf
Alternate Channel Selectivity:
70 dB
Stereo Separation (1 kHz):
35 dB
Frequency Response (± 3 dB):
30 Hz to 15 kHz

AM Tuner

Frequency Range:
531 kHz to 1629 kHz
Usable Sensitivity:
25 μ V

CD Player

System:
Compact disc digital audio system
Usable Discs:
Compact disc
Frequency Response (± 1 dB):
5 Hz to 20 kHz
Signal to Noise Ratio (1 kHz):
100 dB
Dynamic Range (1 kHz):
95 dB
Harmonic Distortion:
0.01%
Channel Separation (1 kHz):
85 dB

MC mode

SHQ:
Approximately 248 minutes
HQ:
Approximately 331 minutes
STD:
Approximately 497 minutes
LP:
Approximately 663 minutes

Notes:

- Specifications and design are subject to change without notice for further improvement.

Audio

Maximum Power Output:
200 W (50 W x 4 ch)
Continuous Average Power Output:
17 W x 4, into 4 Ω , 20 Hz to 20 kHz, 1%THD
Bass Control Action (50 Hz/80 Hz/120 Hz):
+16 dB, -12dB
Treble Control Action (8 kHz/12 kHz):
 ± 12 dB
Line Output Level (CD 1 kHz):
2.0 V

General

Power Supply Voltage:
14.4 V DC (10.8 V to 15.6 V allowable),
negative ground
Current Consumption:
Less than 15 A, 3A
Speaker Impedance:
4 Ω (4 Ω to 8 Ω allowable)
Weight/Source unit:
4.84 lb. (2.2 kg)
Weight/Remote control unit:
1.41 oz. (40 g) (including battery)
Dimensions/Source unit:
7" (Width) x 4" (Height) x 6-3/16" (Depth)
[178 (W) x 100 (H) x 156.5 (D) mm]
Dimensions/Remote control unit
1-3/4" (Width) x 4-7/16" (Height) x 1/2"
(Depth)
[44 (W) x 113 (H) x 13 (D) mm]

Clarion Co., Ltd.

All Rights Reserved. Copyright © 2006: Clarion Co., Ltd.