

clarion®

Owner's manual

使用说明书

คู่มือผู้ใช้

Petunjuk pengguna

DUZ386MP

CD/USB/MP3/WMA/AAC RECEIVER WITH CeNET CONTROL

带CeNET控制的CD/USB/MP3/WMA/AAC接收器

เครื่องรับ CD/USB/MP3/WMA/AAC ที่มีตัวควบคุม CeNET

PENERIMA CD/USB/MP3/WMA/AAC DENGAN KONTROL CeNET

Thank you for purchasing this **Clarion** product.

* Please read this owner's manual in its entirety before operating this equipment.

* After reading this manual, be sure to keep it in a handy place (e.g., glove compartment).

Contents

1. FEATURES	4
2. PRECAUTIONS	4
Handling Compact Discs	5
3. CONTROLS	6
Names of the Buttons and Their Functions	6
Display Items	8
Display Screen	8
4. REMOTE CONTROL	9
Functions of Remote Control Unit Buttons	9
Inserting the Battery	11
5. OPERATIONS	12
Basic Operations	12
Radio Operations	15
CD/MP3/WMA/AAC Operations	17
Operations Common to Each Mode	21
6. ACCESSORIES	25
USB/MTP Operations	25
iPod Operations	27
CD Changer Operations	29
DVD Changer Operations	30
TV Operations	30
7. TROUBLESHOOTING	32
8. ERROR DISPLAYS	34
9. SPECIFICATIONS	35
10. OTHERS	36

1. FEATURES



- USB Direct Connection for iPod® & Digital Media
- Front Panel 3.5mm Auxiliary Input
- Bluetooth® Ready via Auxiliary Input
- * "iPod" is for legal or rightholder-authorized copying only. Don't steal music.
"iPod" is a trademark of Apple Inc., registered in the U.S. and other countries.

2. PRECAUTIONS

1. When the inside of the car is very cold and the player is used soon after switching on the heater moisture may form on the disc or the optical parts of the player and proper playback may not be possible. If moisture forms on the disc, wipe it off with a soft cloth. If moisture forms on the optical parts of the player, do not use the player for about one hour. The condensation will disappear naturally allowing normal operation.
2. Driving on extremely bumpy roads which cause severe vibration may cause the sound to skip.
3. This unit uses a precision mechanism. Even in the event that trouble arises, never open the case, disassemble the unit, or lubricate the rotating parts.

⚠ CAUTION

USE OF CONTROLS, ADJUSTMENTS, OR PERFORMANCE OF PROCEDURES OTHER THAN THOSE SPECIFIED HEREIN, MAY RESULT IN HAZARDOUS RADIATION EXPOSURE.

THE COMPACT DISC PLAYER SHOULD NOT BE ADJUSTED OR REPAIRED BY ANYONE EXCEPT PROPERLY QUALIFIED SERVICE PERSONNEL.

CHANGES OR MODIFICATIONS NOT EXPRESSLY APPROVED BY THE MANUFACTURER FOR COMPLIANCE COULD VOID THE USER'S AUTHORITY TO OPERATE THE EQUIPMENT.

Handling Compact Discs

Use only compact discs bearing the  or



mark.

Do not play heart-shaped, octagonal, or other specially shaped compact discs.

Some CDs recorded in CD-R/CD-RW mode may not be usable.

Handling

- Compared to ordinary music CDs, CD-R and CD-RW discs are both easily affected by high temperature and humidity and some of CD-R and CD-RW discs may not be played.

Therefore, do not leave them for a long time in the car.

- New discs may have some roughness around the edges. If such discs are used, the player may not work or the sound may skip. Use a ball-point pen or the like to remove any roughness from the edge of the disc.

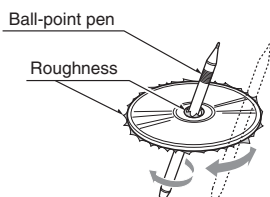

- Never stick labels on the surface of the compact disc or mark the surface with a pencil or pen.
- Never play a compact disc with any cellophane tape or other glue on it or with peeling off marks. If you try to play such a compact disc, you may not be able to get it back out of the CD player or it may damage the CD player.
- Do not use compact discs that have large scratches, are misshapen, cracked, etc. Use of such discs may cause misoperation or damage.
- To remove a compact disc from its storage case, press down on the center of the case and lift the disc out, holding it carefully by the edges.
- Do not use commercially available CD protection sheets or discs equipped with stabilizers, etc. These may damage the disc or cause breakdown of the internal mechanism.

Storage

- Do not expose compact discs to direct sunlight or any heat source.
- Do not expose compact discs to excess humidity or dust.
- Do not expose compact discs to direct heat from heaters.

Cleaning

- To remove fingermarks and dust, use a soft cloth and wipe in a straight line from the center of the compact disc to the circumference.
- Do not use any solvents, such as commercially available cleaners, anti-static spray, or thinner to clean compact discs.
- After using special compact disc cleaner, let the compact disc dry off well before playing it.

3. CONTROLS

Names of the Buttons and Their Functions

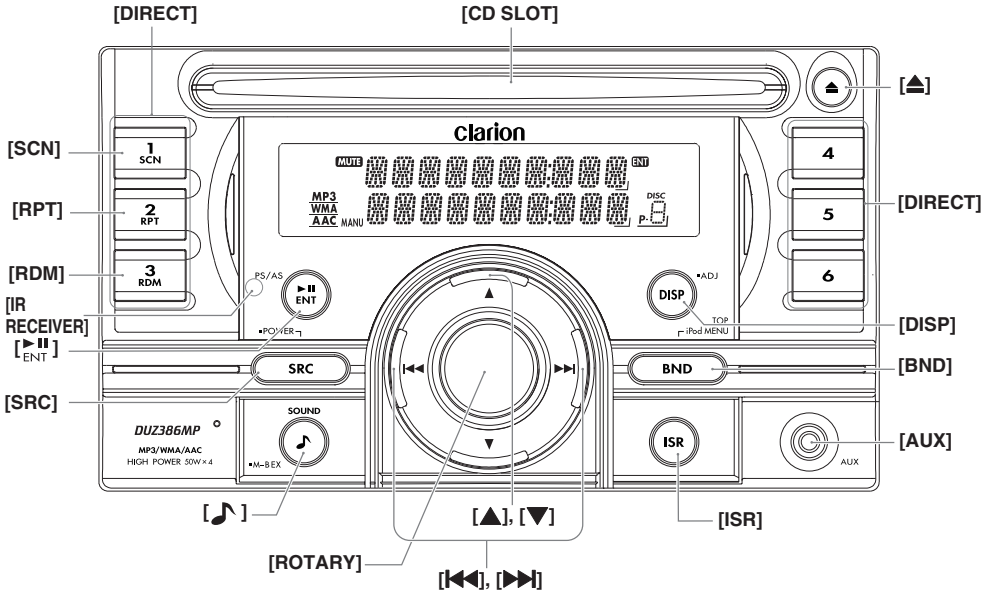

[ENT] button

- Perform preset scan while in the radio mode. When the button is pressed and held, auto store is performed.
- Play or pause a track while in the CD/MP3/WMA/AAC mode.
- Confirm various settings.

[IR RECEIVER]

- Receiver for remote control unit. (Operating range: 30° in all directions)

[RDM] button

- Perform random play while in the CD/MP3/WMA/AAC mode.
- Press and hold the button for 1 second or longer to perform folder random play while in the MP3/WMA/AAC mode.

[RPT] button

- Perform repeat play while in the CD/MP3/WMA/AAC mode.
- Press and hold the button for 1 second or longer to perform folder repeat play while in the MP3/WMA/AAC mode.

[SCN] button

- Perform scan play for 10 seconds of each track while in the CD/MP3/WMA/AAC mode.
- Press and hold the button for 1 second or longer to perform folder scan play while in the MP3/WMA/AAC mode.

[DIRECT] buttons

- Store a station into memory or recall it directly while in the radio mode.

[CD SLOT]

- CD insertion slot.

[▲] (EJECT) button

- Eject a disc when it is loaded into the unit.

[DISP] button

- Switch the display indication.
- Press and hold the button for 1 second or longer to enter the adjust mode.

[BND] button

- Switch the band, or seek tuning or manual tuning while in the radio mode.
- Play a first track while in the CD/MP3/WMA/AAC mode.
- Press the button to change the character.

[AUX] input jack

- The input jack for connecting an external device.

[ISR] button

- Recall ISR radio station in memory.
- Press and hold the button for 2 seconds or longer: Store current station into ISR memory (radio mode only).

[▲] (UP), [▼] (DN) buttons

- Select the folder while in the MP3/WMA/AAC mode.
- Use the buttons to perform various settings.

[◀◀], [▶▶] buttons

- Select a station while in the radio mode or select a track while in the CD/MP3/WMA/AAC mode.

This button is used to make various settings.

- Press and hold the button for 1 second or longer to enter the fast-forward or fast-backward mode.

[ROTARY] knob

- Adjust the volume by turning the knob clockwise or counterclockwise.

[🎵] button

- Use the button to switch to the sound adjust mode.
- Press and hold the button for 1 second or longer to turn on or off the MAGNA BASS EXTEND mode.

[SRC] button

- Press the button to turn on the power.
- Press and hold the button for 1 second or longer to turn off the power.
- Switch the operation mode among the radio mode, etc.

Display Items

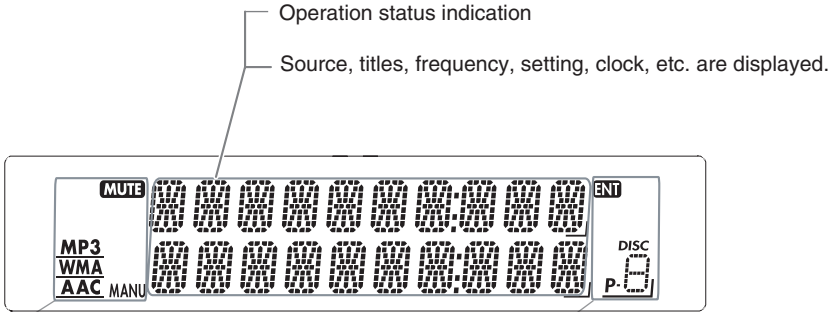

MUTE : Mute indication
MP3 : MP3 indication
WMA : WMA indication
AAC : AAC indication
MANU : Manual indication

ENT : Enter indication
DISC : Disc No./Preset
P : channel indication

Display Screen

In extreme cold, the screen movement may slow down and the screen may darken, but this is normal. The screen will recover when it returns to normal temperature.

4. REMOTE CONTROL

Functions of Remote Control Unit Buttons

If you buy the RCB-176-200 sold separately, you can enjoy the use of the Remote Control function.

* Some buttons on the remote control unit have different functions from the corresponding buttons on the main unit.

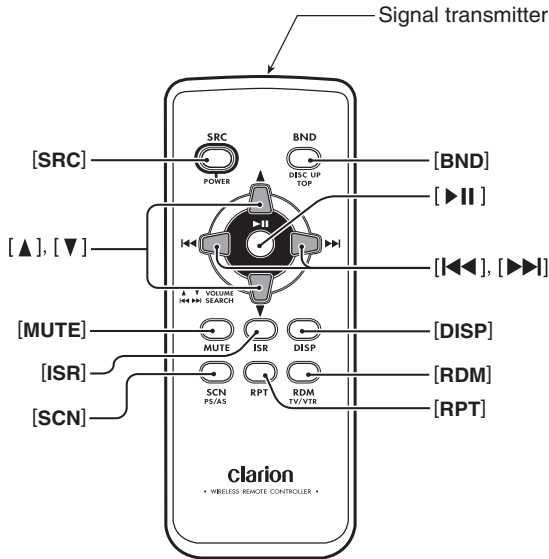

● Shared modes

[SRC] button

- Press the button to turn on the power.
Press and hold the button for 1 second or longer to turn off the power.
- Use to alternate operation mode among the various modes.

[▲], [▼] buttons

- Increases and decreases volume.

[MUTE] button

- Turns mute function on and off.

[ISR] button

- Recalls ISR radio station stored in memory.
- Press and hold the button for 2 seconds or longer to store current station in ISR memory (radio mode only).

[DISP] button

- Press to select the desired display.

● Radio mode

[BND] button

- Switches reception band.

[◀◀], [▶▶] buttons

- Moves preset channels up and down.

[SCN] button

- Press to perform preset scan.
- Press and hold the button for 2 seconds or longer to perform auto store.

● CD/MP3/WMA/AAC and USB/MTP modes

[BND] button

- Press to play the first track.

[◀◀], [▶▶] buttons

- Press to move the tracks up and down.
- Press and hold for 1 second or longer to perform fast-forward/fast-backward (Except DRM file).

Functions of Remote Control Unit Buttons

[▶||] button

- Switches between playback and pause.

[SCN] button

- Press to perform scan play.
- When in MP3/WMA/AAC and USB/MTP modes, press and hold the button for 1 second or longer to perform folder scan play.

[RPT] button

- Press to perform repeat play.
- When in MP3/WMA/AAC and USB/MTP modes, press and hold the button for 1 second or longer to perform folder repeat play.

[RDM] button

- Press to perform random play.
- When in MP3/WMA/AAC and USB/MTP modes, press and hold the button for 1 second or longer to perform folder random play.

● CD changer/DVD changer modes

[BND] button

- Press to switch to next disc in ascending order.

[◀◀], [▶▶] buttons

- Press to move the tracks up and down.
- Press and hold the button for 1 second or longer to perform fast-forward/fast-backward.

[▶||] button

- Switches between playback and pause.

[SCN] button

- Press to perform scan play.
- Press and hold the button for 1 second or longer to perform disc scan play.

[RPT] button

- Press to perform repeat play.
- Press and hold the button for 1 second or longer to perform disc repeat play.

[RDM] button

- Press to perform random play.
- Press and hold the button for 1 second or longer to perform disc random play.

● iPod mode

[◀◀], [▶▶] buttons

- Press to move the tracks up and down.
- Press and hold the button for 1 second or longer to perform fast-forward/fast-backward.

[▶||] button

- Switches between playback and pause.

[RPT] button

- Press to perform repeat play.

[RDM] button

- Press to perform random play.
- Press and hold the button for 1 second or longer to perform all random play.

● TV mode

[BND] button

- Switches reception band.

[◀◀], [▶▶] buttons

- Moves preset channels up and down.

[SCN] button

- Press to perform preset scan.
- Press and hold the button for 2 seconds or longer to perform auto store.

[RDM] button

- Press to alternate between TV and VTR.

Inserting the Battery

- ① Turn over the remote control unit and slide the cover in the direction indicated by the arrow in the illustration.
- ② Insert the battery (CR2025) into the insertion guides, with the printed side (+) facing upwards.
- ③ Press the battery in the direction indicated by the arrow so that it slides into the compartment.
- ④ Replace the cover and slide in until it clicks into place.

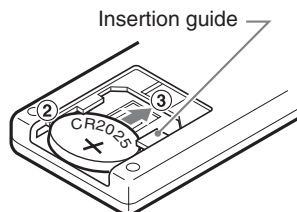
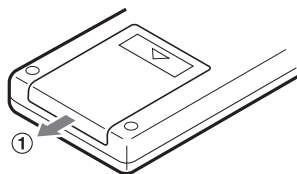

Notes:

Misuse may result in rupture of the battery, producing leakage of fluid and resulting in personal injury or damage to surrounding materials. Always follow these safety precautions:

- Use only the designated battery.
- When replacing the battery, insert properly, with +/- polarities oriented correctly.
- Do not subject battery to heat, or dispose of in fire or water. Do not attempt to disassemble the battery.
- Dispose of used batteries properly.

5. OPERATIONS

Note:

- Be sure to read this chapter referring to the front diagrams of chapter "3. CONTROLS" on page 6.

Basic Operations

⚠ CAUTION

Be sure to lower the volume before switching off the unit power or the ignition key. The unit remembers its last volume setting. If you switch the power off with the volume up, when you switch the power back on, the sudden loud volume may hurt your hearing and damage the unit.

Turning on/off the power

Note:

- Be careful about using this unit for a long time without running the engine. If you drain the car's battery too far, you may not be able to start the engine and this can reduce the service life of the battery.

1. Press the [SRC] button.
2. The illumination and display on the unit light up. The unit automatically remembers its last operation mode and will automatically switch to display that mode.
3. Press and hold the [SRC] button for 1 second or longer to turn off the power for the unit.

Note:

- **System check**
The first time this unit is turned on after the wire connections are completed, it must be checked what equipment is connected. When the power is turned on, the "SYSTEM CHECK" appears in the display, then the unit returns to the clock display mode. The system check starts within the unit. Then press the [SRC] button again, the unit turn to the radio mode.

Selecting a mode

1. Press the [SRC] button to change the operation mode.
2. Each time you press the [SRC] button, the operation mode changes in the following order:
Radio → CD/MP3/WMA/AAC → USB/MTP/iPod → (CD changer) → (DVD changer) → (TV) → AUX → Radio...
* External equipment not connected with CeNET is not displayed.
* iPod/MTP can connect to this unit via USB cable.

Adjusting the volume

1. Turning the [ROTARY] knob clockwise increases the volume; turning it counterclockwise decreases the volume.
* The volume level is from 0 (minimum) to 33 (maximum).

Switching the display

Press the [DISP] button to select the desired display.

- * Once selected, the preferred display becomes the display default. When a function adjustment such as volume is made, the screen will momentarily switch to that function's display, then revert back to the preferred display several seconds after the adjustment.
- * If the button operation is performed with the screen saver function on, the operation display corresponding to the button operation is shown for about 30 seconds and the display returns to the screen saver display.

For details, refer to the subsection "Turning the screen saver function on or off" in section "Operations Common to Each Mode".

Sound Adjustment

You can adjust a sound effect or tone quality to your preference.

To change sound setting

1. Press the [🎵] button to switch to the sound adjustment selection display.
 - * The factory default sound setting is "Z-EHCR".
2. Then press the [◀▶] or [▶▶] button to select the sound adjustment mode. Each time you press the [◀▶] or [▶▶] button, the sound adjustment mode changes as following order:
 "Z-EHCR" ↔ "BALANCE" ↔ "FADER"
 * In the case of display blinking "ENT", you can press the [ENT] button to adjust the setting value.
3. Press the [▲] or [▼] button to adjust the selected audio mode.
4. After completing settings, press the [🎵] button to return to the previous mode.

● Setting the Z-Enhancer Plus

This unit is provided with 4 types of sound tone effects stored in memory.

Select the one you prefer.

* The factory default setting is "OFF".

- 2-1. Select "Z-EHCR".
- 3-1. Each time you press the [▲] or [▼] button, the tone effect changes in the following order:
 "Z+FLAT" ↔ "CUSTOM" ↔ "EXCITE" ↔ "IMPACT" ↔ "B-BOOST" ↔ "OFF"
Z+FLAT : user Z+FLAT
CUSTOM : user custom
EXCITE : bass and treble emphasized
 mid emphasized
IMPACT : bass and treble emphasized
B-BOOST : bass emphasized
OFF : no sound effect

When "Z+FLAT" is set:

- 3-2. Press and hold the [ENT] button for 1 second or longer, bass/treble characteristics become flat and switch to the "CUSTOM" mode.

When "CUSTOM" is set:

- 3-2. Press the [ENT] button to enter the "BASS/TREBLE" adjust mode.

When "EXCITE/IMPACT/B-BOOST" is set:

- 3-2. Press the [ENT] button.
- 3-3. Press the [▲] or [▼] button to adjust the setting in the range of -3 to +3.
 - * The factory default setting is "0".
- 3-4. Press the [ENT] button to return to the previous mode.

● Adjusting the bass/treble

This adjustment can be performed only when the Z-Enhancer Plus is set to "CUSTOM".

- 3-2. Press the [ENT] button.
- 3-3. Press the [◀▶] or [▶▶] button to select as following order.

BASS G ↔ **BASS F** ↔ **BASS Q** ↔
TREBLE G ↔ **TREBLE F**

The factory default setting is "BASS G".

- 3-4. Press the [ENT] button.
- 3-5. Press the [▲] or [▼] button to select the setting.
 - BASS G**: The factory default setting is "0". (Adjustment range: +7 to -7)
 - BASS F**: The factory default setting is "60". (Adjustment range: 60/80/100/200)
 - BASS Q**: The factory default setting is "1". (Adjustment range: 1/1.25/1.5/2)
 - TREB G**: The factory default setting is "0". (Adjustment range: +7 to -7)
 - TREB F**: The factory default setting is "10K". (Adjustment range: 10K/12.5K/15K/17.5K)
- 3-6. Press the [ENT] button to return to the previous mode.

Basic Operations

● Adjusting the balance

2-1. Select **"BALANCE"**.

3-1. Press the [▲] or [▼] button to adjust the balance of the right and left speakers.

* The factory default setting is **"CENTER"** (center). (Adjustment range: RIGHT12 to LEFT12 (right 12 to left 12))

● Adjusting the fader

2-1. Select **"FADER"**.

3-1. Press the [▲] or [▼] button to adjust the balance of the rear and front speakers.

* The factory default setting is **"CENTER"** (center). (Adjustment range: FRONT12 to REAR12 (front 12 to rear 12))

Note:

- *During SOUND adjustment mode, if no operation is performed for more than 10 seconds, this mode can be cancelled and return to previous mode.*

Setting the MAGNA BASS EXTEND

The MAGNA BASS EXTEND does not adjust the low frequencies like the normal sound adjustment function, but emphasizes the deep bass frequencies to provide you with a dynamic sound.

* The factory default setting is **"OFF"** (off).

1. Press and hold the [🎵] button for 1 second or longer to turn on the MAGNA BASS EXTEND effect. **"M-B EX ON"** appears in the display for 2 seconds.
2. Press and hold the [🎵] button for 1 second or longer to turn off the MAGNA BASS EXTEND effect. **"M-B EX OFF"** appears in the display for 2 seconds.

Radio Operations

Listening to the radio

1. Press the [SRC] button and select the radio mode. The frequency appears in the display.
2. Press the [BND] button and select the radio band. Each time the button is pressed, the radio reception band changes in the following order:
FM1 → FM2 → FM3 → AM → FM1...
3. Press the [◀◀] or [▶▶] button to tune in the desired station.

Tuning

There are 3 types of tuning mode available, seek tuning, manual tuning and preset tuning.

Seek tuning

1. Press the [BND] button and select the desired band (FM or AM).
 - * If "MANU" is lit in the display, press and hold the [BND] button for 1 second or longer. "MANU" in the display goes off and seek tuning is now available.
2. Press the [◀◀] or [▶▶] button to automatically seek a station.
When the [▶▶] button is pressed, the station is sought in the direction of higher frequencies; if the [◀◀] button is pressed, the station is sought in the direction of lower frequencies.

Manual tuning

There are 2 ways available: Quick tuning and step tuning.

When you are in the step tuning mode, the frequency changes one step at a time. In the quick tuning mode, you can quickly tune the desired frequency.

1. Press the [BND] button and select the desired band (FM or AM).
 - * If "MANU" is not lit in the display, press and hold the [BND] button for 1 second or longer. "MANU" is lit in the display and manual tuning is now available.
2. Tune into a station.

● Quick tuning

Press and hold the [◀◀] or [▶▶] button for 1 second or longer to tune in a station.

● Step tuning

Press the [◀◀] or [▶▶] button to manually tune in a station.

Recalling a preset station

A total of 24 preset positions (6-FM1, 6-FM2, 6-FM3, 6-AM) exists to store individual radio stations in memory. Press the corresponding [DIRECT] button or the [▲] / [▼] button to recall the stored radio frequency automatically.

1. Press the [BND] button and select the desired band (FM or AM).
2. Press the corresponding [DIRECT] button or the [▲] / [▼] button to recall the stored station.

Note:

- Press and hold one of the [DIRECT] buttons for 2 seconds or longer to store that station into preset memory.

Manual memory

1. Select the desired station with seek tuning or manual tuning.
2. Press and hold one of the [DIRECT] buttons for 2 seconds or longer to store the current station into preset memory.

Auto store

Auto store is a function for storing up to 6 stations that are automatically tuned in sequentially. If 6 receivable stations cannot be received, a previously stored station remains unoverwritten at the memory position.

1. Press the [BND] button and select the desired band (FM or AM).
2. Press and hold the [▶ENT] button for 2 seconds or longer. The stations with good reception are stored automatically to the preset channels.
 - * If auto store is performed in the FM bands, the stations are stored in FM3 even if FM1 or FM2 was chosen for storing stations.

Radio Operations

Preset scan

Preset scan receives the stations stored in preset memory in order. This function is useful when searching for a desired station in memory.

1. Press the [▶_{ENT}] button.
2. When a desired station is tuned in, press the [▶_{ENT}] button again to continue receiving that station.

Note:

- Be careful not to press and hold the [▶_{ENT}] button for 2 seconds or longer, otherwise the auto store function is engaged and the unit starts storing stations.

Instant station recall (ISR)

Instant station recall is a special radio preset that instantly accesses a favorite radio station at a touch of a button. The ISR function even operates with the unit in other modes.

● ISR memory

1. Select the station that you wish to store in ISR memory.
2. Press and hold the [ISR] button for 2 seconds or longer.

● Recalling a station with ISR

In any mode, press the [ISR] button to turn on the radio function and tune the selected radio station. "ISR" appears in the display. Press the [ISR] button again to return to the previous mode.

MP3/WMA/AAC

What is MP3?

MP3 is an audio compression method and classified into audio layer 3 of MPEG standards. This audio compression method has penetrated into PC users and become a standard format.

This MP3 features the original audio data compression to about 10 percent of its initial size with a high sound quality. This means that about 10 music CDs can be recorded on a CD-R disc or CD-RW disc to allow a long listening time without having to change CDs.

What is WMA?

WMA is the abbreviation of Windows Media Audio, an audio file format developed by Microsoft Corporation.

Notes:

- If you play a file with DRM (Digital Rights Management) for WMA remaining ON, no audio is output (The WMA indicator blinks).
- Windows Media™, and the Windows® logo are trademarks, or registered trademarks of Microsoft Corporation in the United States and/or other countries.

● To disable DRM (Digital Rights Management)

1. When using Windows Media Player 9/10/11, click on TOOL → OPTIONS → MUSIC RECORD tab, then under Recording settings, unclick the Check box for RECORD PROTECTED MUSIC. Then, reconstruct files.

Personally constructed WMA files are used at your own responsibility.

What is AAC?

- AAC is an acronym for “Advanced Audio Coding” and refers to the audio compression method used with video compression standards MPEG-2 and MPEG-4.
- AAC files composed with the following conditions can be played:
 - AAC files encoded with iTunes.
 - iTunes Ver. 7.0 or earlier.
 - File extension “.m4a” (“.M4A”)
- Tracks purchased at an iTunes Music store, and copyright-protected files cannot be played.
- When playing AAC files that include image data, additional time may be required before playback begins.
- Files may not play properly, depending on the iTunes version under which an AAC file is encoded.

Precautions when creating MP3/WMA/AAC file

● Usable sampling rates and bit rates

1. MP3: Sampling rate 8 kHz-48 kHz,
Bit rate 8 kbps-320 kbps / VBR
2. WMA: Bit rate 8 kbps-320 kbps
3. AAC: Sampling rate 8 kHz-48 kHz,
Bit rate 8 kbps-320 kbps / VBR

● File extensions

1. Always add a file extension “.MP3”, “.WMA” or “.M4A” to MP3, WMA or AAC file by using single byte letters. If you add a file extension other than specified or forget to add the file extension, the file cannot be played.
2. Files without MP3/WMA/AAC data will not play. The files will be played soundlessly if you attempt to play files without MP3/WMA/AAC data.
 - * When VBR files are played, the play time display may differ the play location.
 - * When MP3/WMA/AAC files are played, a little no sound part is caused between tunes.

CD/MP3/WMA/AAC Operations

● Logical format (File system)

1. When writing MP3/WMA/AAC file on a CD-R disc or CD-RW disc, please select "ISO9660 level 1, 2 or JOLIET or Romeo" or APPLE ISO as the writing software format. Normal play may not be possible if the disc is recorded on another format.
2. The folder name and file name can be displayed as the title during MP3/WMA/AAC play but the title must be within 64 single byte alphabetical letters and numerals (including an extension).
3. Do not affix a name to a file inside a folder having the same name.

● Folder structure

1. A disc with a folder having more than 8 hierarchical levels will be impossible.

● Number of files or folders

1. Up to 255 files can be recognized per folder. Up to 510 files can be played.
2. Tracks are played in the order that they were recorded onto a disc. (Tracks might not always be played in the order displayed on the PC.)
3. Some noise may occur depending on the type of encoder software used while recording.

Set the type of file to be played (multi-session function)

When a single disc holds both normal CD type tracks and MP3/WMA/AAC type tracks, use this command to select which type of track to play.

* Default setting is "MULTI-SESS CD".

- When only one type of track (either music CD or MP3/WMA/AAC) is recorded on a disc, selecting either type will allow playback of the disc.
- When playing CCCD (copy-control CDs), set to CD type.

1. Press and hold the [BND] button for 1 second or longer.

Each time the button is held pressed in this way, the playback type alternates between CD type and MP3/WMA/AAC type.

- **"MULTI-SESS CD"**

When playing music CD only.

- **"MULTI-SESS MP3"**

When playing music MP3/WMA/AAC only.

2. When setting is completed, remove the disc and reinsert it.

Disc-In-Play function

As long as the ignition key is turned to the ON or ACC position, this function allows you to turn the power to the unit and start playing the disc automatically when the disc is inserted even if the power is not turned on.

CAUTION

- **Do not try to put your hand or fingers in the disc insertion slot. Also never insert foreign objects into the slot.**
- **Do not insert discs where adhesive comes out from cellophane tape or a rental CD label, or discs with marks where cellophane tape or rental CD labels were removed. It may be impossible to extract these discs from the unit and they may cause the unit to break down.**

Backup Eject function

Just pressing the [▲] button, ejects the disc even if the power to the unit was not turned on.

1. Press the [▲] button to eject the CD. Take it out from the ejected position. "EJECT" appears in the display.

Notes:

- If a CD (12 cm) is left in the ejected position for 15 seconds, the CD is automatically reloaded (Auto reload).
- If you force a CD into before auto reloading, this can damage the CD.

Listening to a disc already loaded in the unit

Press the [SRC] button to select the CD/MP3/WMA/AAC mode.

When the unit enters the CD/MP3/WMA/AAC mode, play starts automatically.

If there is no disc loaded, the indication “**NO DISC**” appears in the title display.



The mode changes each time the [SRC] button is pressed. (Modes are not displayed for equipment that is not connected.)

Radio → CD/MP3/WMA/AAC → USB/MTP/iPod → (CD changer) → (DVD changer) → (TV) → AUX → Radio ...

Loading a CD

1. Insert a CD into the center of the CD SLOT with the labeled side facing up. “**LOADING**” appears in the display, the CD enters into the slot, and the play starts.

Notes:

- Never insert foreign objects into the CD SLOT.
- If the CD is not inserted easily, there may be another CD in the mechanism or the unit may require service.
- Discs not bearing the  or  mark and CD-ROMs cannot be played by this unit.
- Some CDs recorded in CD-R/CD-RW mode may not be usable.

Pausing play

1. Press the [▶||] button to pause play. “**PAUSE**” appears in the display.
2. To resume CD play, press the [▶||] button again.

Displaying CD titles

This unit can display title data for CD-text/MP3/WMA/AAC disc and user titles input with this unit.

1. Each time you press the [DISP] button to change the title display.

● CD-TEXT disc

User → Track → Disc (Artist) → User ...

● MP3/WMA/AAC disc

Track → Folder → Title (Album) → Artist → Track ...

Notes:

- If the CD playing is not a CD-text CD or no user title has been input, “**NO TITLE**” appears in the display.
- If MP3/WMA/AAC disc is not input TAG, “**NO TITLE**” appears in the display.
- For MP3, supports ID3 Tags V2.3 / 2.2 / 1.1 / 1.0.
- Tag displays give priority to V2.3 / 2.2.
- In the case of album Tags for WMA, the information written into the extension header is displayed.
- Only ASCII characters can be displayed in Tags.

Selecting a track

● Track-up

1. Press the [▶▶] button to move ahead to the beginning of the next track.
2. Each time you press the [▶▶] button, the track advances ahead to the beginning of the next track.

● Track-down

1. Press the [◀◀] button to move back to the beginning of the current track.
2. Press the [◀◀] button twice to move back to the beginning of the previous track.

Fast-forward/fast-backward

● Fast-forward

1. Press and hold the [▶▶] button for 1 second or longer.

● Fast-backward

1. Press and hold the [◀◀] button for 1 second or longer.

* For MP3/WMA/AAC discs, it takes some time until the start of searching and between tracks. In addition, the playing time may have a margin of error.

CD/MP3/WMA/AAC Operations

Folder Select

This function allows you to select a folder containing MP3/WMA/AAC files and start playing from the first track in the folder.

1. Press the [▼] or [▲] button.
Press the [▲] button to move the next folder.
Press the [▼] button to move the previous folder.
2. To select a track, press the [◀◀] or [▶▶] button.

Top function

The top function resets the CD player to the first track of the disc. Press the [BND] button to play the first track (track No. 1) on the disc.

* In case of MP3/WMA/AAC, the first track of a folder being played will be returned.

Other various play functions

● Scan play

This function allows you to locate and play the first 10 seconds of all the tracks recorded on a disc.

1. Press the [SCN] button to perform scan play.
“SCAN” appears in the display for 2 seconds.
* Scan play starts from the next track after the track currently being played.

● Folder scan play

This function allows you to locate and play the first 10 seconds of the first track of all the folders on an MP3/WMA/AAC disc.

1. Press and hold the [SCN] button for 1 second or longer to perform folder scan play.
“ALL SCAN” appears in the display for 2 seconds.
* Folder scan play starts from the next folder after the folder currently being played.

● Repeat play

This function allows you to play the current track repeatedly.

1. Press the [RPT] button to perform repeat play.
“REPEAT” appears in the display for 2 seconds.

● Folder repeat play

This function allows you to play a track currently being played in the MP3/WMA/AAC folder repeatedly.

1. Press and hold the [RPT] button for 1 second or longer to perform folder repeat play.
“ALL RPT” appears in the display for 2 seconds.

● Random play

This function allows you to play all tracks recorded on a disc in a random order.

1. Press the [RDM] button to perform random play.
“RANDOM” appears in the display for 2 seconds.

● Folder random play

This function allows you to play all the tracks of all the folders recorded on an MP3/WMA/AAC disc in a random order.

1. Press and hold the [RDM] button for 1 second or longer to perform folder random play.
“ALL RDM” appears in the display for 2 seconds.

● To cancel play

1. Press the operating button previously selected.
* The various play mode is canceled and the various play off mode appears in the display for 2 seconds.

To change adjustment setting

1. Press and hold the [DISP] button for 1 second or longer to switch to the adjustment selection display.
2. Press the [◀◀] or [▶▶] button to select the "item name".
 "CLOCK" ↔ "CONTRAST" ↔ "SETTINGS"
 ↔ "CODE" ↔ "SCRN SVR" ↔ "MESSAGE INPUT"
 ↔ "SCROLL" ↔ "DIMMER" ↔ "BLINKLED"
 ↔ "TEL-SP" ↔ "TEL-SW" ↔ "SYSTEM CHECK"
3. Press the [▲] or [▼] button to select the "desired setting value".
 - * In the case of display blinking "ENT", you can press the [ENT] button to adjust the setting value.
 - * After completing settings, press the [DISP] button to return to the previous mode.

● Setting the clock

- 2-1. Select "CLOCK".
- 3-1. Press the [ENT] button.
- 3-2. Press the [◀◀] or [▶▶] button to select the hour or the minute.
- 3-3. Press the [▲] or [▼] button to set the correct time.
 - * The clock is displayed in 12-hour format.
- 3-4. Press the [ENT] button to store the time into memory.

Note:

- You cannot set the clock when it is displayed with only the ignition on. If you drain or remove the car's battery or take out this unit, the clock is reset. While setting the clock, if another button or operation is selected, the clock set mode is canceled.

● Setting the contrast

You can adjust the display contrast to match the angle of installation of the unit.

- * The factory default setting is "10". (Adjustment level: 1 to 16)
- 2-1. Select "CONTRAST".
 - 3-1. Press the [▲] or [▼] button to adjust the contrast.

● Displaying the settings

The number of indicator of this unit decreases, you can see the state of current settings at any operation mode.

- 2-1. Select "SETTINGS".
- 3-1. Press the [▲] or [▼] button to display the state of current settings.
 - * When the setting is selected, after 1 second the current state will be displayed.

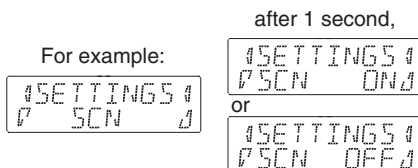

Setting the anti-theft function (CATS)

"CATS" is the acronym of "Clarion Anti-Theft System".

When you set a PIN code (called as "Personal Code"), a theft is prevented by disabling the operation of the unit at the theft.

Setting your Personal Code

- 2-1. Select "CODE".
- 3-1. Press the [ENT] button.
 - The set personal code screen appears.
- 4-1. Press the [DIRECT] buttons [1]-[6] to enter your desired 4-digit Personal Code.
- 5-1. Press and hold the [ENT] button for 2 seconds or longer.
 - The entered Personal Code will be set, and it will return to the previous screen.

Note:

- Write down your Personal Code in case you forget it.

Erasing the Personal Code

- 2-1. Select "CODE".
- 3-1. Press the [ENT] button.
 - The ERASE PERSONAL CODE screen appears.
- 4-1. Enter the Personal Code currently.
- 5-1. Press and hold the [ENT] button for 2 seconds or longer.
 - Enter a Personal Code mode is cancelled.

Operations Common to Each Mode

When the ENTER PERSONAL CODE screen appears

The ENTER PERSONAL CODE screen will be displayed when turning the ACC power on after performing the following operations:

- The car battery was replaced.
- The backup power was cut off.
- The [RESET] button was pressed.

Note:

• If you have lost your Personal Code, please contact Clarion customer service.

1. Enter your Personal Code currently set.
2. When the correct Personal Code is entered, the unit will restart from the initial startup screen.

Notes:

- When you enter a wrong Personal Code, the message "LOCK - - -" is displayed and the Personal Code entry is prohibited for a while. This prohibited time is changed according to the number of times of wrong code entry as follows:
 - 1 to 6 times: 15 seconds
 - 7 times or more: 15 minutes

● Turning the screen saver function on or off

This unit is provided with the screen saver function which allows you to show various kinds of patterns and characters in the operation status indication area of the display in a random order. You can turn on or off this function. If the button operation is performed with the screen saver function on, the operation display corresponding to the button operation is shown for about 30 seconds and the display returns to the screen saver display.

* The factory default setting is "ON".

2-1. Select "SCRN SVR".

3-1. Press the [▲] or [▼] button to select the setting.

Each time you press the [▲] or [▼] button, the setting changes in the following order:

"MESSAGE" ↔ "ON" ↔ "OFF"

● Entering message information

Message up to 30 characters long can be stored in memory and displayed as a type of screen saver setting.

* The factory default setting is "WELCOME TO CLARION".

2-1. Select "MESSAGE INPUT".

3-1. Press the [▶] button.

3-2. Press and hold the [BND] button for 1 second or longer to clear the old message.

3-3. Press the [◀] or [▶] button to move the cursor.

3-4. Press the [BND] button to select a character type. Each time you press the [BND] button, the character type changes in the following order:

Capital letters → Numbers → Symbols → Capital letters...

3-5. Press the [▲] or [▼] button to select the desired character.

3-6. Repeat step 3-3 to 3-5 to enter up to 30 characters for message.

3-7. Press and hold the [▶] button for 2 seconds or longer to store the message in memory.

* Press and hold the [BND] button for 1 second or longer to cancel the input message. Then press and hold the [▶] button for 2 seconds or longer to store the message and the message return to default setting.

● Setting the method for title scroll

Set how to scroll in CD-TEXT, MP3/WMA/AAC title.

* The factory default setting is "ON".

2-1. Select "SCROLL".

3-1. Press the [▲] or [▼] button to select "ON" or "OFF".

• ON:

To scroll automatically.

• OFF:

To scroll just 1 time.

* When you want to see the title again, in the title mode, press and hold the [DISP] button for 3 seconds or longer to scroll the title.

Operations Common to Each Mode

● Setting the dimmer control

You can set the dimmer control “ON” or “OFF”.

* The factory default setting is “ON”.

2-1. Select “DIMMER”.

3-1. Press the [▲] or [▼] button to select “ON” or “OFF”.

● Anti-theft indicator

The red Anti-theft indicator is a function for preventing theft. When the ACC is off, this indicator blinks.

* The factory default setting is “OFF”.

2-1. Select “BLINKLED”.

3-1. Press the [▲] or [▼] button to select “ON” or “OFF”.

● Setting the car speaker output for the cellular phone

* The factory default setting is “LEFT”.

* To output the telephone calls, set the cellular phone interrupt to “ON”.

When the AUX input jack is used to connect an AUX BLUETOOTH BB (BLT370) (sold separately):

2-1. Select “TEL-SP”.

3-1. Press the [▲] or [▼] button to select “RIGHT” or “LEFT”.

● RIGHT:

Telephone calls can be heard on the front right speaker connected to this unit.

● LEFT:

Telephone calls can be heard on the front left speaker connected to this unit.

● Cellular phone interrupt setting

If you connect this unit and your cellular phone with a separately sold cable, you can listen to your telephone calls on your car speakers.

* The factory default setting is “OFF”.

2-1. Select “TEL-SW”.

3-1. Press the [▲] or [▼] button to select the setting. Each time you press the [▲] or [▼] button, the setting changes in the following order:

“OFF” ↔ “ON” ↔ “MUTE”

● OFF:

This unit continues normal operation even when the cellular phone is used.

● ON:

You can listen to your telephone calls from the speakers connected to this unit.

* When listening to your calls on your car speakers, you can adjust the volume by turning the [ROTARY] knob.

● MUTE:

The sound from this unit is muted during telephone calls.

Note:

• If connecting a hands-free kit, please ensure the setting is ON to receive the telephone audio through the system.

● Performing a system check

This function allows you to perform a system check from the adjust mode when required.

2-1. Select “SYSTEM CHECK”.

3-1. Press and hold the [ENT] button for 1 second or longer.

“SYSTEM CHECK” appears in the display, then the unit returns to the previous operation mode.

Operations Common to Each Mode

Entering titles

Titles up to 10 characters long can be stored in memory and displayed for CD, CD changer, Radio stations and TV stations. The number of titles that can be entered for each mode are as follows.

Mode	Number of titles
CD mode	50 titles
TV mode	20 titles
Radio mode	30 titles

CD changer mode	Number of titles
DCZ625 connected	100 titles

1. Press the **[SRC]** button to select the mode you want to enter a title (Radio, CD, CD changer or TV).
2. Select and play a CD in the CD changer or tune in to a TV station or Radio for which you want to enter the title.
3. Press and hold the **[DISP]** button for 1 second or longer.
4. Press the **[◀◀]** or **[▶▶]** button to select "TITLE INPUT".
5. Press the **[▶■]** button.
The display switches to the title input display.
6. Press the **[◀◀]** or **[▶▶]** button to move the cursor.
7. Press the **[BND]** button to select a character type. Each time you press the **[BND]** button, the character type changes in the following order:
Capital letters → Numbers → Symbols → Capital letters...
8. Press the **[▲]** or **[▼]** button to select the desired character.
9. Repeat steps 6 to 8 to enter up to 10 characters for the title.
10. Press and hold the **[▶■]** button for 2 seconds or longer to store the title into memory.

Clearing titles

1. Select and play a CD in the CD changer or tune in to a TV station or Radio for which you want to clear the title.
2. Press and hold the **[DISP]** button for 1 second or longer.
3. Press the **[◀◀]** or **[▶▶]** button to select "TITLE INPUT".
4. Press the **[▶■]** button.
The display switches to the title input display.
5. Press and hold the **[BND]** button for 1 second or longer.
All characters in the title disappear.
6. Press and hold the **[▶■]** button for 2 seconds or longer to store the setting.

AUX function

This system has an external input jack on the front panel so you can listen to sounds and music from external devices connected to this unit.

● Selecting AUX IN sensitivity

Make the following settings to select the sensitivity when sounds from external devices connected to this unit are difficult to hear even after adjusting the volume.

* The factory default setting is "MID".

1. Press and hold the **[DISP]** button for 1 second or longer.
2. Press the **[◀◀]** or **[▶▶]** button to select "AUX SENS".
3. Press the **[▲]** or **[▼]** button to select "HIGH", "MID" or "LOW".

Note:

When the AUX mode is selected, setting AUX IN sensitivity is available.

6. ACCESSORIES

USB/MTP Operations

USB memory/MTP device operation

Note:

- The following operations are the same as for CD mode:
 - *Pause
 - *Track selection
 - *Fast-forward/fast-backward (Except DRM file)
 - *Top function
 - *Scan play
 - *Repeat play
 - *Random play
 - *Folder selection
- See “**CD/MP3/WMA/AAC Operations**” (page 17-20) for details.

About USB memory

- USB is an acronym for Universal Serial Bus, and refers to an external bus standard supporting data transfer rates of 12 Mbps.
- This unit is compatible with USB 1.1/2.0 with maximum data transfer rates of 12 Mbps.
- USB memory devices that can be played by connecting to the unit’s USB cable are limited to those recognized as “USB mass storage class devices”; operation is not guaranteed with all USB memory devices.
 - * Devices compatible with “USB Mass Storage Class” can be used merely by connecting to the host device, without need for special drivers or application software.
- Consult the manufacturer of your USB memory device for information regarding whether it is supported by “USB Mass Storage Class” standards.
- Audio files playable on this unit are limited to MP3/WMA/AAC files. For details, see the section “**MP3/WMA/AAC**” (page 17).
- To prevent the accidental loss of data, always back up important data on your computer.
- This unit does not support connections to a computer. In addition, connections made through a USB hub device are also not supported.
- When a USB memory device is composed of two or more drives, only one of the drives will be detected.

- USB memory devices with security functions cannot be played.
- The order in which tracks are recorded may differ depending on the USB memory device connected (the actual playback order may not be the same as that indicated on your computer’s display).
- If you operate folder up/down continuously, the play time display keeps as “00:00”, and the sound is not emitted.

About USB Digital Media Streaming

This unit supports USB Digital Media Streaming. USB Digital Media Streaming is a function used to play music files transmitted using Media Transfer Protocol (MTP). This function also supports the playback of WMDRM 10 files.

During USB Digital Media Streaming, the unit displays the “**MTP**” mode indicator.

Use of USB Digital Media Streaming requires the purchase of a supported portable audio player. For information regarding supported portable audio players, consult your nearest Clarion dealer, or visit Clarion’s website.

CAUTION

- **Insert and remove a USB memory/MTP device only when the device is not being accessed. Connecting or disconnecting the device at the following times may result in the loss of data:**
 - If the USB memory/MTP device is removed or power is disconnected during writing to the device.
 - When the device is subjected to static electricity or electric noise.
- **Do not leave a USB memory/MTP device unattended in an automobile. Exposure to direct sunlight or high temperatures may cause deformation or other malfunction of the USB memory/MTP device.**
- **Do not turn on vehicle ignition when the MTP device is connected, since it may result in loss or damage to data on the MTP device. Connect the MTP device to the USB cable after vehicle ignition is turned on.**

USB/MTP Operations

Connecting a USB memory/MTP device

1. Connect the USB memory/MTP device to the USB cable.

Playback will begin from the first file recorded on the device.

- * If the device is not recognized, press the [SRC] button to switch the source to the device.
- * Always insert the device fully into the connector. Incomplete connections may cause the device not to be recognized.
- * Depending on the number of tracks recorded, some amount of time may be required until all tracks are read into the unit.
- * The order in which tracks are recorded may differ depending on the device connected (the actual playback order may not be the same as that indicated on your computer's display).

To listen to tracks on a connected USB memory/MTP device

1. Press the [SRC] button to switch the source. When USB memory/MTP device is selected, playback (except DRM file) will begin from the location at which playback was previously stopped.
 - * When a USB memory/MTP device is connected the USB/MTP mode will be displayed.
 - * When a USB memory/MTP device is disconnected and then reconnected, playback will begin from the beginning of the USB memory/MTP device.
 - * When the "MTP" mode is selected, the AAC files on the MTP device can not be played.

To stop play

1. Press the [SRC] button and switch the function to a source other than the USB memory.

CAUTION

Do not remove the USB memory/MTP device when the USB/MTP mode is selected, since it may result in loss or damage to data on the USB memory/MTP device.

Always backup and save important data on your computer.

2. Remove the USB memory/MTP device from the USB cable.

This section describes operations when connected to an Apple iPod via the USB cable.

Notes:

- See the *iPod Owner's Manual* for details regarding operation conditions.
- The unit will not operate, or may operate improperly with unsupported versions.
- For a list of compatible Apple iPod unit with this model, please contact your clarion dealer or www.clarion.com.

Connecting an iPod

When an iPod is connected to the USB cable, "Shuffle" set on the iPod will become as follows:

- "Shuffle (Albums)" play → Random play
- "Shuffle (Songs)" play → All random play

The iPod has two modes, the "Play mode" and the "iPod menu mode" for selecting tracks.

Switch between these modes by pressing the [BND] button.

Notes:

- When an iPod is connected to the USB cable, please use the attached connecting cable with the iPod unit.

Select iPod mode

1. Press the [SRC] button.

Playback will begin from the last file that was played on the iPod.

Note:

- The following operations in Play mode operate the same as in CD mode:

*Track selection: [◀◀], [▶▶]

*Fast-forward/fast-backward: [◀◀], [▶▶]

*Pause: [▶||]

*Top function: [BND]

See "CD/MP3/WMA/AAC Operations" (page 17-20) for details.

Other various play functions (in Play mode)

Notes:

- These functions are not supported when in the iPod menu mode.
- The Random function set on the iPod remains the same after attachment/detachment of the iPod.
- The Repeat function on the iPod will be changed when you connect/disconnect the iPod to the unit.

● Repeat play

Play back one track repeatedly.

1. Press the [RPT] button.

● Random play

Play all albums within a selected category, in random order. (Corresponds to "Shuffle (Albums)" command on iPod.)

1. Press the [RDM] button.

● All random play

Play all tracks within a selected category, in random order. (Corresponds to "Shuffle (Songs)" command on iPod.)

1. Press and hold the [RDM] button for 1 second or longer.

● To cancel play

1. Press the same play button once again.

Notes:

- When the repeat play mode is canceled, after play all tracks within a selected category, playback will begin from the first track in the selected category.
- When playing the last track within a selected category in Random mode, if ACC is switched off then on again, playback will begin from a different track.
- Through the default setting of an iPod is "ALL Repeat", the indication on the mode status is not displayed.

iPod Operations

Selecting category from the iPod menu

1. Press and hold the [BND] button for 1 second or longer to select the iPod menu mode.
The iPod menu categories will be displayed.

Notes:

- Repeat and Random mode operations are not supported when in the iPod menu mode.
 - In the iPod menu mode, if you press the [◀◀]/[▶▶] button or the [▲]/[▼] button fast, the playback may not be performed.
2. Press the [▲] or [▼] button to switch between categories.

The iPod menu categories alternate in the following order:

“PLAYLISTS” ↔ “ARTISTS” ↔
“ALBUMS” ↔ “SONGS” ↔ “GENRES” ↔
“COMPOSERS”...

Note:

The iPod menu mode can be canceled by performing one of the following operations:

- Press the [BND] button.
 - When the category select screen is displayed, press the [▶▶] button.
3. Press the [▶▶] button to select the category.
 4. When the track name display is showing, press the [▶▶] button.
Playback will begin from the first track in the selected category, and the iPod menu mode will be canceled.
* Subfolders may be displayed, depending on the category.
In this case, use the [▲] and [▼] buttons to switch between subfolders, then use the [▶▶] button to select the desired subfolder.
* When the track name display is showing, pressing the [◀◀] button will return to the currently playing folder name display.
 5. Use the [▲] and [▼] buttons to select a track within a category.

Selecting category using preset memory

1. Press and hold the [BND] button for 1 second or longer to select the iPod menu mode.

The category can be set as follows in the [DIRECT] (1-6) buttons.

[1] : PLAYLISTS

[2] : ARTISTS

[3] : ALBUMS

[4] : SONGS

[5] : GENRES

[6] : COMPOSERS

2. Press the desired [DIRECT] (1-6) button to select the category.
* Subfolders may be displayed, depending on the category.
In this case, use the [▲] and [▼] buttons to switch between subfolders, then use the [▶▶] button to select the desired subfolder.
3. When the track name display is showing, press the [▶▶] button.
Playback will begin from the first track in the selected category, and the iPod menu mode will be canceled.
* Use the [▲] and [▼] buttons to select a track within a category.

About title display

This unit supports the display of title information transmitted from a connected iPod.

- Character code information is UTF-8; displayable characters include English alphanumerics, some symbols, and some umlaut characters.
- Unsupported characters will be replaced by asterisks (*).

CD Changer Operations

Note:

- The following operations are the same as for CD mode:

- *Pause
- *Track selection
- *Fast-forward/fast-backward
- *Scan play
- *Repeat play
- *Random play

See “**CD/MP3/WMA/AAC Operations**” (page 17-20) for details.

CD changer functions

When an optional CD changer is connected through the CeNET cable, this unit controls all CD changer functions. This unit can control a total of 2 changers.

Press the [SRC] button and select the CD changer mode to start play. If 2 CD changers are connected, press the [SRC] button to select the CD changer for play.

- * If “**NO MAG**” appears in the display, insert the magazine into the CD changer. “**D-CHECK**” appears in the display while the player loads (checks) the magazine.
- * If “**NO DISC**” appears in the display, eject the magazine and insert discs into each slot. Then, reinsert the magazine back into the CD changer.

Note:

- Some CDs recorded in CD-R/CD-RW mode may not be usable.

⚠ CAUTION

CD-ROM discs cannot be played from every CD changer, it's depended on the model.

Displaying CD titles

This unit can display title data for CD-text CDs and user titles input with this unit.

- * Title data for CD-text CDs can be displayed with this unit only when it is connected to DCZ625.

1. Press the [DISP] button to change the title display.

Notes:

- If the CD playing is not a CD-text CD or no user title has been input, “**NO TITLE**” appears in the display.
- If a CD-text CD is not input its disc title or a track title, “**NO TITLE**” appears in the display.

Procedure to scroll a title

Set “**SCROLL**” to “**ON**” or “**OFF**”.

(The factory default setting is “**ON**”. Refer to the subsection “**Setting the method for title scroll**” in section “**Operations Common to Each Mode**”.)

● When set to “ON”

The title is automatically kept scrolling.

● When set to “OFF”

To scroll just 1 time.

When you want to see the title again, in the title mode, press and hold the [DISP] button for 3 seconds or longer to scroll the title.

Selecting a CD

1. Press the [▲] or [▼] button to select the desired disc.

- * If a CD is not loaded in a slot of magazine, pressing the [▲] or [▼] button can not work.

Other various play functions

● Disc scan play

Disc scan play locates and plays the first 10 seconds of the first track on each disc in the currently selected CD changer. This function continues automatically until it is cancelled.

- * Disc scan play is useful when you want to select a desired CD.

1. Press and hold the [SCN] button for 1 second or longer. “**ALL SCAN**” appears in the display and disc scan play starts.

● Disc repeat play

After all the tracks on the current disc have been played, disc repeat play automatically replays the current disc over from the first track. This function continues automatically until it is cancelled.

1. Press and hold the [RPT] button for 1 second or longer. “**ALL RPT**” appears in the display and disc repeat play starts.

● Disc random play

The disc random play selects and plays individual tracks or discs automatically in no particular order. This function continues automatically until it is cancelled.

1. Press and hold the [RDM] button for 1 second or longer. “**ALL RDM**” appears in the display and disc random play starts.

● To cancel play

1. Press the operating button previously selected.

DVD Changer Operations

By connecting an optional DVD changer that supports CeNET wiring, this unit can be used to control the DVD changer. To view DVDs, an optional monitor is required.

- The DVD control and display functions supported by this unit are limited; the unit does not support all the functions possible on a DVD changer.

For fullest functionality, use the remote control unit provided with your DVD changer to control its operations. For details, consult the Owner's Manual provided with your DVD changer.

Note:

- The following operations are the same as for CD and CD Changer modes:

***Pause**

***Track selection**

***Fast-forward/fast-backward**

***Scan play**

***Repeat play**

***Random play**

See "**CD/MP3/WMA/AAC Operations**" (page 17-20) and "**CD Changer Operations**" (page 29) for details.

TV Operations

Note:

- The following operations are performed the same as for radio mode:

***Channel selection**

***Storing channels in memory**

***Calling channels from memory**

***Auto store**

***Preset scan**

See "**Radio Operations**" (page 15-16) for details.

TV tuner functions

When an optional TV tuner is connected through the CeNET cable, this unit controls all TV tuner functions. To watch TV requires a TV tuner and monitor.

Watching a TV

1. Press the [SRC] button and select the TV mode.
2. Press the [BND] button to select the desired TV band (TV1 or TV2). Each time the button is pressed, the input selection toggles between TV1 and TV2.
3. Press the [◀◀] or [▶▶] button to tune in the desired TV station.

Watching a video

The TV tuner has a VTR input terminal to which 1 external device can be connected. Connect a 12 V video cassette player (VCP) or video cassette recorder (VCR) to the TV tuner input terminal.

- * The factory default setting is "TV".

1. Press and hold the [DISP] button for 1 second or longer to switch to the adjustment selection display.
2. Press the [◀◀] or [▶▶] button to select "TV/VTR".
3. Press and hold the [▶▶] button for 1 second or longer to set to "VTR".
4. To return to the TV broadcast, press and hold the [DISP] button for 1 second or longer to switch to the adjustment selection display.
5. Press the [◀◀] or [▶▶] button to select "TV/VTR".
6. Press and hold the [▶▶] button for 1 second or longer to set to "TV".

Setting the TV Area

When you select the TV area (TV reception area) TV tuner area setting changes.

1. Press and hold the **[DISP]** button for 1 second or longer to switch to the adjustment selection display.
2. Press the **[◀◀]** or **[▶▶]** button to select **"TV AREA"**.
3. Press the **[▲]** or **[▼]** button to select the reception area.
4. Press the **[DISP]** button to return to the previous mode.

Setting the TV diver

You can change the reception setting for the TV antenna connected to the TV tuner.

* The factory default setting is **"ON"**.

1. Press and hold the **[DISP]** button for 1 second or longer to switch to the adjustment selection display.
2. Press the **[◀◀]** or **[▶▶]** button to select **"TV DIVER"**.
3. Press the **[▲]** or **[▼]** button to set to **"ON"** or **"OFF"**.
 - **ON:**
Sets the diver setting to ON.
 - **OFF:**
Sets the diver setting to OFF.
4. Press the **[DISP]** button to return to the previous mode.

7. TROUBLESHOOTING

	Problem	Cause	Measure
General	Power does not turn on. (No sound is produced.)	Fuse is blown.	Replace with a fuse of the same amperage. If the fuse blows again, consult your store of purchase.
		Incorrect wiring.	Consult your store of purchase.
	No sound output when operating the unit with amplifiers or power antenna attached.	Power antenna lead is shorted to ground or excessive current is required for remote-on the amplifiers or power antenna.	<ol style="list-style-type: none"> 1. Turn the unit off. 2. Remove all wires attached to the power antenna lead. Check each wire for a possible short to ground using an ohm meter. 3. Turn the unit back on. 4. Reconnect each amplifier remote wire to the power antenna lead one by one. If the amplifiers turn off before all wires are attached, use an external relay to provide remote-on voltage (excessive current required).
	Nothing happens when buttons are pressed.	The microprocessor has malfunctioned due to noise, etc.	Turn off the power, then press the reset button for about 2 seconds with a thin rod.
	Display is not accurate.		
		DCP or main unit connectors are dirty.	Wipe the dirt off with a soft cloth moistened with cleaning alcohol.
	No sound heard	The speaker protection circuit is operating.	<ol style="list-style-type: none"> 1. Turn down sound volume. Function can also be restored by turning the power off and on again. (Speaker volume is reduced automatically when the speaker protection circuit operates). 2. If the sound is muted again, consult our service department.
CD/MP3/WMA/AAC	No sound heard	MP3/WMA/AAC files are absent in a disc.	Write MP3/WMA/AAC files onto the disc properly.
		Files are not recognized as an MP3/WMA/AAC file.	Use MP3/WMA/AAC files encoded properly.
		File system is not correct.	Use ISO9660 level 1, 2 or JOLIET or Romeo or APPLE ISO file system.
	Sound skips or is noisy.	Compact disc is dirty.	Clean the compact disc with a soft cloth.
		Compact disc is heavily scratched or warped.	Replace with a compact disc with no scratches.
	Sound is cut or skipped. Noise is generated or noise is mixed with sound.	MP3/WMA/AAC files are not encoded properly.	Use MP3/WMA/AAC files encoded properly.
	Sound is bad directly after power is turned on.	Water droplets may form on the internal lens when the car is parked in a humid place.	Let dry for about 1 hour with the power on.
Wrong filename	File system is not correct.	Use ISO9660 level 1, 2 or JOLIET or Romeo or APPLE ISO file system.	

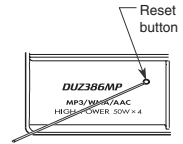

	Problem	Cause	Measure
USB/MTP/iPod	No sound heard	The device contains no MP3/WMA/AAC files.	Record MP3/WMA/AAC files properly to the device.
		The files are not proper MP3/WMA/AAC format.	Use only properly encoded MP3/WMA/AAC files.
		Connectors are loose.	Disconnect the device and reconnect securely.
	Sound is interrupted or has noise.	The MP3/WMA/AAC files are improperly encoded.	Use only properly encoded MP3/WMA/AAC files.
	The device isn't recognized.	The device is damaged.	Disconnect the device and reconnect. If the device is still not recognized, try replacing with a different device.
		Connectors are loose.	
		According to the state of operation on the device, the communication fault is caused.	Disconnect the device and reconnect.
Can't insert the device.	The devices has been inserted improperly.	Try reversing the connection direction of the device (usually the brand name surface should be facing left).	
	The connector is broken.	Replace with a new device.	

8. ERROR DISPLAYS

If an error occurs, one of the following displays is displayed.

Take the measures described below to eliminate the problem.

	Error Display	Cause	Measure
CD/MP3/WMA/AAC	ERROR 2	A CD is caught inside the CD deck and is not ejected.	This is a failure of CD deck's mechanism and consult your store of purchase.
	ERROR 3	A CD cannot be played due to scratches, etc.	Replace with a non-scratched, non-warped-disc.
	ERROR 6	A CD is loaded upside-down inside the CD deck and does not play.	Eject the disc then reload it properly.
CD changer	ERROR 2	A CD inside the CD changer is not loaded.	This is a failure of CD changer's mechanism and consult your store of purchase.
	ERROR 3	A CD inside the CD changer cannot be played due to scratches, etc.	Replace with a non-scratched, non-warped disc.
	ERROR 6	A CD inside the CD changer cannot be played because it is loaded upside-down.	Eject the disc then reload it properly.
DVD changer	ERROR 2	A DISC inside the DVD changer cannot be played.	This is a failure of DVD mechanism and consult your store of purchase.
	ERROR 3	A DISC cannot be played due to scratches, etc.	Retry or replace with a non-scratched, non-warped-disc.
	ERROR 6	A DISC inside the DVD changer cannot be played because it is loaded upside-down.	Eject the disc then reload it properly.
	ERROR P	Parental level error	Set the correct Parental level.
	ERROR R	Region code error	Eject the disc and replace correct region code disc.
USB/MTP/iPod	ERROR 2	The files are not proper MP3/WMA/AAC format.	Use only properly encoded MP3/WMA/AAC files.
	ERROR 3 (USB/MTP mode)	The MP3/WMA/AAC files are improperly encoded.	Use only properly encoded MP3/WMA/AAC files.
	ERROR 3 (iPod mode)	The iPod contains no audio files.	Insert an iPod containing audio files.
	ERROR 5	The connected devices are not recognized.	Disconnect the device and reconnect.
	BUS-PWR	Overcurrent detection.	Disconnect the devices and reconnect. If the devices are still not recognized, try replacing with a different devices.
	HUB	The connected devices are not recognized.	Disconnect the devices and reconnect. If the devices are still not recognized, try replacing with a different devices.

If an error display other than the ones described above appears, press the reset button. If the problem persists, turn off the power and consult your store of purchase.

9. SPECIFICATIONS

FM Tuner

Frequency Range: 87.0 MHz to 108.0 MHz
Usable Sensitivity: 11 dB μ V
50dB Quieting Sensitivity: 17 dB μ V
Alternate Channel Selectivity: 60 dB
Stereo Separation (1 kHz): 30 dB
Frequency Response (± 3 dB): 30 Hz to 15 kHz

AM Tuner

Frequency Range: 531 kHz to 1629 kHz
Usable Sensitivity: 28 dB μ V

CD Player

System: Compact disc digital audio system
Usable Discs: Compact disc
Frequency Response (± 1 dB): 20 Hz to 20 kHz
Signal to noise Ratio (1 kHz): 90 dB
Dynamic Range (1 kHz): 80 dB
Harmonic Distortion: 0.03%

Note:

- *Specifications and design are subject to change without notice for further improvement.*

Audio

Maximum Power Output: 200 W (50 W \times 4 ch)
Bass Control Action (100 Hz): +14 dB, -14 dB
Treble Control Action (10 kHz): +14 dB, -14 dB
Line Output Level (CD 1 kHz): 2 V

General

Power Supply Voltage:
14.4 V DC (10.8 to 15.6 V allowable), negative ground
Current Consumption: Less than 15 A
Speaker Impedance: 4 Ω (4 Ω to 8 Ω allowable)
Auto Antenna Rated Current: 500 mA or less
Weight / Source unit: 1.56 kg
Dimensions / Source unit:
178 (W) \times 100 (H) \times 155 (D) mm

10. OTHERS

WMDRM 10 for devices

- This product is protected by certain intellectual property rights of Microsoft. Use or distribution of such technology outside of this product is prohibited without a license from Microsoft.
- Content owners use Windows Media digital rights management technology (WMDRM) to protect their intellectual property, including copyrights. This device uses WMDRM software to access WMDRM-protected content. If the WMDRM software fails to protect the content, content owners may ask Microsoft to revoke the software's ability to use WMDRM to play or copy protected content. Revocation does not affect unprotected content. When you download licenses for protected content, you agree that Microsoft may include a revocation list with the licenses. Content owners may require you to upgrade WMDRM to access their content. If you decline an upgrade, you will not be able to access content that requires the upgrade.

Clarion Co., Ltd.

All Rights Reserved. Copyright © 2007: Clarion Co., Ltd.
Printed in China / Imprimé en Chine / Impreso en China

2007/12

PE-3051K
280-8608-00