

clarion®

QUICK START GUIDE & INSTALLATION MANUAL

คู่มือการเริ่มต้นใช้งานตัวนและคู่มือติดตั้ง

快速入门指南 & 安装手册

PEDOMAN MULAI CEPAT & PETUNJUK PEMASANGAN

NX502A

DVD MULTIMEDIA STATION WITH BUILT-IN NAVIGATION & 6.2" TOUCH PANEL CONTROL

เครื่องเล่น DVD มีลติมีเดีย พร้อมแผงควบคุมระบบสัมผัสและระบบนำทางในตัวขนาด 6.2"

带内置导航及 6.2 英寸触屏式控制器的多媒体 DVD 播放器

STASIUN MULTIMEDIA DVD DENGAN NAVIGASI DAN KONTROL PANEL SENTUH 6,2" BUILT-IN

Contents

This guide is intended to guide you through the basic functions of the unit.

Precautions	2
Operational Panel	3
Turning the Power On	3
Selecting a Source	3
Source Media Modes	4
DVD Video mode	4
CD Playback	4
MP3/WMA Playback	4
MP4/DivX Playback	4
iPod® Audio Playback	5
iPod Video Playback	5
Radio mode	5
Bluetooth Operations	6
Pairing	6
Bluetooth Telephone Menu	6
Making a call	6
Bluetooth Audio Playback	6
Start using Clarion Mobile Map	6
Selecting the destination of a route	6
Map Screen	7
Quick Menu	7
Installation Guide	7
Before Starting	7
Package Contents	7
Cautions On Installation	7
Installing The Main Unit	8
Cautions On Wiring	8
Installing The GPS Antenna	9
Wire Connection	9

Notes

- For details of functions and operation of this product, refer to "Owner's manual".
- The screens shown in the examples may differ from actual screens. Actual screens may be changed without notice for performance and function improvements.

Precautions

⚠ WARNING

For your safety, the driver should not operate the controls while driving. Also, while driving, keep the volume to a level at which external sounds can be heard.

1. When the interior of the car is extremely cold and the player is used soon after switching on the heater, moisture may form on the disc or the optical parts of the player and proper playback may not be possible. If moisture forms on the disc, wipe it off with a soft cloth. If moisture forms on the optical parts of the player, do not use the player for about one hour. The condensation will disappear naturally allowing normal operation.
2. Driving on extremely bumpy or rough roads can cause the disc to skip during playback.
3. This unit uses precision parts and components for its operation. In the event that trouble arises, never open the case, disassemble the unit, or lubricate the rotating parts. Contact your Clarion dealer or service center.
4. "Made for iPod," and "Made for iPhone" mean that an electronic accessory has been designed to connect specifically to iPod, or iPhone, respectively, and has been certified by the developer to meet Apple performance standards. Apple is not responsible for the operation of this device or its compliance with safety and regulatory standards. Please note that the use of this accessory with iPod or iPhone may affect wireless performance. iPhone and iPod are trademarks of Apple Inc., registered in the U.S. and other countries.

Ⓜ DOLBY DIGITAL

- Manufactured under license from Dolby Laboratories. "Dolby" and the double-D symbol are trademarks of Dolby Laboratories.
6. This product incorporates copyright protection technology that is protected by U.S. patents and other intellectual property rights. Use of this copyright protection technology must be authorized by Rovi Corporation, and is intended for home and other limited viewing uses only unless otherwise authorized by Rovi Corporation. Reverse engineering or disassembly is prohibited. Use of this product by the customer is restricted to play program materials to which the Rovi copyright protection process has been applied.
 7. The Bluetooth® word mark and logos are registered trademarks owned by Bluetooth SIG, Inc. and any use of such marks by Clarion Co., Ltd. is under license.
 8. DivX®, DivX Certified® and associated logos are trademarks of Rovi Corporation or its subsidiaries and are used under license.

DivX Certified® to play DivX® video, including premium content.

Covered by one or more of the following U.S. patents: 7,295,673; 7,460,668; 7,515,710; 7,519,274

ABOUT DIVX VIDEO: DivX® is a digital video format created by DivX, LLC, a subsidiary of Rovi Corporation. This is an official DivX Certified® device that plays DivX video. Visit divx.com for more information and software tools to convert your files into DivX videos.

ABOUT DIVX VIDEO-ON-DEMAND: This DivX Certified® device must be registered in order to play purchased DivX Video-on-Demand (VOD) movies. To obtain your registration code, locate the DivX VOD section in your device setup menu. Go to vod.divx.com for more information on how to complete your registration.

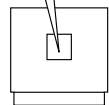

Operational Panel

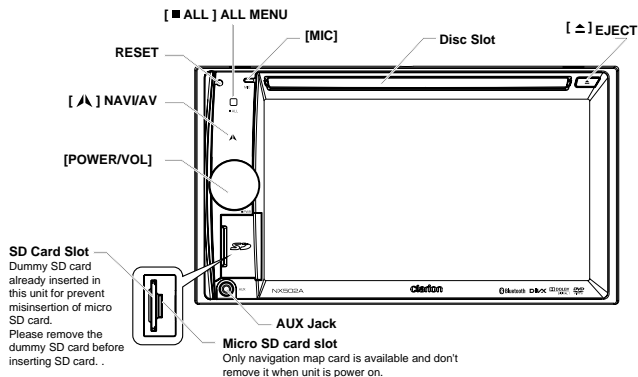

[POWER/VOL] Knob

- Press to power on the system when ignition on.
- When power on, short press to mute the volume.
- Rotate the knob to increase or decrease the volume.
- Press and hold this key more than 1 second to turn off the system.

[ALL] ALL MENU Button

- Short press to show/exit shortcut menu.
- Long press to show/exit main source menu.

[NAVI/AV] Button

- Press to enter navigation mode;
- Press again to return current source.

[EJECT] Button

- Press to eject disc.

[MIC] Hole

- Internal microphone

[RESET] Button

- Press to load original settings.

Note: When the [RESET] button is pressed, frequencies of radio stations, titles, etc. stored in memory are cleared.

Turning the Power On



Start the engine. The power is supplied to this unit.



Press [POWER/VOL] button on the panel to turn on the unit.

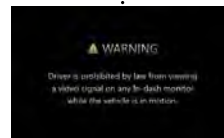
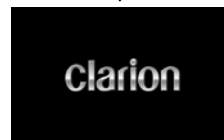

Selecting a Source

Long press [ALL] button on the PANEL to show main source menu.

Touch [-] on the bottom of screen to show front zone sources.

Change page by dragging left or right or touching other [-] buttons.

Touch the icons on the screen to enter corresponding work mode, such as Disc mode, Tuner mode, Telephone mode, etc.

Source Media Modes

When you select the desired source mode (for example, the DVD Video, USB or iPod mode), the following screen will appear.
During playback, touch the bottom half of screen to show operation bar.

DVD Video mode

1. Play/Pause/Stop(long press)
2. Show cursor keys in DVD title menu
3. Previous chapter
Fast-backward (long press)
4. Progress bar
5. Next chapter
Fast-forward (long press)
6. Root menu
7. Show other options
8. Repeat play
9. Select audio language
10. Select subtitle language
11. Show next page
12. Select DVD angle
13. Back to main operation bar
14. Show previous page
15. Turn on Widescreen mode
16. Direct search
17. Adjust picture effect
18. Show playback information
19. Mute indicator

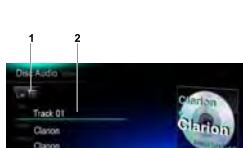

CD Playback

1. Show track list (Browse)
2. Title/Artist/Album information
3. Play/Pause
4. Repeat play
5. Previous track
Fast reverse (long press)
6. Progress bar
7. Next track
Fast forward (long press)
8. Random play
9. Show other options
Scan: Scan play stored stations



Source Media Modes

MP3/WMA Playback

1. Show folder/file list (Browse)
2. Folder/Title/Artist/Album information
3. Play/Pause
4. Repeat play
5. Previous track
Fast reverse (long press)
6. Progress bar
7. Next track
Fast forward (long press)
8. Random play
9. Show other options
10. Scan play
11. Rotate the album image
12. Back to main operation bar



MP4/DivX Playback

1. Play/Pause
2. Repeat playback
3. Previous file
Fast reverse (long press)
4. Progress bar
5. Next file
Fast forward (long press)
6. Stop and show list menu (Browse)
7. Show other options
8. Select audio language
9. Select subtitle language
10. Turn on Widescreen mode
11. Show playback information
12. Back to main operation bar

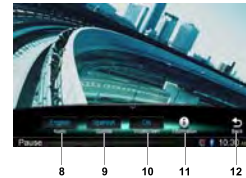
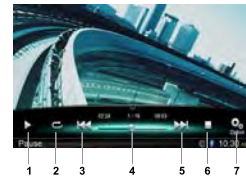

Source Media Modes

iPod® Audio Playback

1. Show file list (Browse)
2. Switch between iPod Audio and Video
3. Song/Artist/Album information
4. Play/Pause
5. Repeat play
6. Previous track
Fast reverse (long press)
7. Progress bar
8. Next track
Fast forward (long press)
9. Random play
10. Show other options
11. Turn on / off Simple Control
12. Select Audiobook play speed
13. Back to main operation bar



iPod Video Playback

1. Play/Pause
2. Repeat play
3. Previous file
Fast reverse (long press)
4. Progress bar
5. Next file
Fast forward (long press)
6. Show iPod list menu
7. Show other options
8. Turn on / off Simple Control
9. Turn on Widescreen mode
10. Back to main operation bar

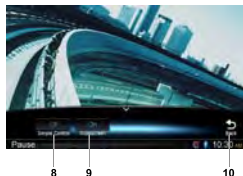
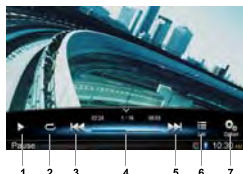

Source Media Modes

Radio mode

1. Band switch
2. Information area
3. Preset station number
4. Current station frequency
5. Show preset stations list
6. Scan preset stations
7. Manual tune backward
Auto tune backward. (long press)
8. Frequency bar
9. Manual tune forward
Auto tune forward. (long press)
10. Show other options
11. Choose local or distant seeking mode
12. Store stations automatically
13. Back to main operation bar

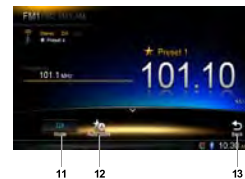
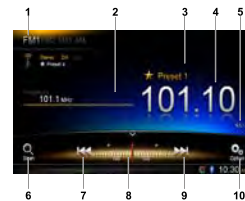

Bluetooth Operations

Pairing

1. Touch [Custom] on the bottom left of the main menu, then select [Settings] to enter Setting menu.
2. Touch [Setup], then touch the button to the right of "Bluetooth" to show Bluetooth setting menu.
3. Select [On] to the right of "Bluetooth".
4. Turn on Bluetooth function of your mobile phone.
5. Enter mobile phone's Bluetooth setup menu.
6. Search for new Bluetooth devices.
7. Select **NX502A** from the pairing list on the mobile phone.
8. Enter the password. (Default password: "0000")
9. After pairing successfully,  icon on the bottom right of the screen turns blue.

Bluetooth Telephone Menu

1. Show history categories
2. Backspace
3. Paired device information
4. Number pad
5. Call/Hang up

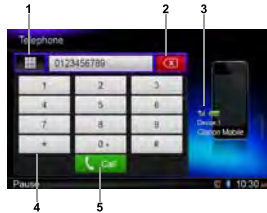

Making a call

• Dial Number

1. Input numbers by digit-keys on the screen.
2. Touch [Call] button to dial.
Touch [Back] button to delete characters.
3. Touch [End] button to terminate call.

You can access Dialed/Missed/Received Call History and your phone book by touching  button.

• Answering a call

- You can answer an incoming call by pressing the [Call] button.
* Touch [End] button to reject an incoming call.

Bluetooth Audio Playback

1. Title/Artist/Album information
2. Play/Pause
3. Previous track
Fast reverse (long press)
4. Stop
5. Next track
Fast forward (long press)





Start using Clarion Mobile Map

When Clarion Mobile Map is started the first time, you need to do the following:

1. Select the written language of the application interface. Later you can change it in Settings.
2. Select the language and speaker used for voice guidance messages. Later you can change it in Settings.
3. Read and accept the End User Licence Agreement.
4. Read and accept the road safety warning.
After this, the Navigation menu appears and you can start using Clarion Mobile Map.

Selecting the destination of a route

To enter an address as the destination, do as follows:

1. If you are on the Map screen, tap  to return to the Navigation menu.
2. In the Navigation menu, tap the following buttons:  .



3. Selecting a destination by entering the address or the postal code
4. Selecting the destination from the Places of Interest
5. Selecting a map location as the destination
6. Selecting the destination from your Favourites
7. Selecting your Home location
8. Searching for a Place of Interest by its phone number
9. Entering the coordinate of the destination
10. Selecting a recent destination from the History
11. Additional options



• For the information about other ways, see the user manual.

Start using Clarion Mobile Map

Map Screen

12. To enlarge this small map and open the Map screen, tap **[Show Map]** button
13. Zooming in and out
14. Tilting up and down
15. Rotating left and right
16. 2D or 3D view
17. Compass in 2D map view mode
18. Compass in 3D map view mode
19. Location information
20. Return to normal navigation
21. Select destination



Quick Menu

22. The Quick menu is a selection of controls and functions that are frequently needed during navigation. It can be opened directly from the Map screen by tapping .
23. Find / Find Places /Quick Search (This function lets you search for a Place along your route or around your current location if there is no route calculated)
24. Find / Favourite (This button opens the list of your Favourite destinations)
25. Find / History (This button opens the History list. You can select one of your previous destinations)
26. My Route / Edit Route (This button opens the route editing function)
27. More / Settings / Route Settings (This button opens the route related settings)
28. More / Settings / Map Settings (This button opens the map related settings)
29. Tap the Current Street field on the Map screen (This button opens a special screen with information about the current position and a button to search for nearby emergency or roadside assistance).
30. My Route / Cancel Route (This button cancels the route and stops navigation. The button is replaced with the next one if waypoints are given)

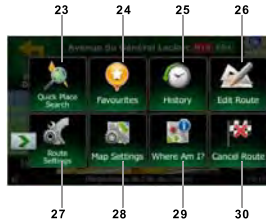

Installation Guide

Before Starting

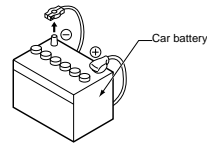

1. This set is exclusively for use in cars with a negative ground, 12 V power supply.
2. Read these instructions carefully.
3. Be sure to disconnect the battery "⊖" terminal before starting. This is to prevent short circuits during installation.

Package Contents

Source unit	1	Quick Start Guide	1
Wiring harness	1	Owner's manual (CD-R)	1
GPS antenna	1	Electro tap	2
CLAMP for GPS antenna's cable	3	Flush mount bolts(M5x6)	8
DOUBLE FACE TAPE for GPS Antenna...	1	Hexagon Head Screw(M5x6)	8
Remote control unit	1	AV cable	1
Battery (CR2025).....	1	Line out cable	1
(Installed in remote control)		Rear Zone out cable	1
2Din Trim ring (wide)	1	SWC cable.....	1
2Din Trim ring (narrow).....	1	External Microphone cable	1
Cleaning cloth.....	1	Camera Visual IN AUX2 cable	1
Warranty Card.....	1	USB cable.....	1

Cautions On Installation

1. Prepare all articles necessary for installing the main unit before starting.
2. Install the unit within 30° of the horizontal plane.
3. If you have to do any modification on the car body, such as drilling holes, consult your car dealer beforehand.
4. Use the included screws for installation. Using other screws can cause damage.
5. This unit has a fan motor in the back of the main unit so as not to raise the temperature in the source unit. When the fan motor vent is covered with cords or mounting bracket, it may cause a malfunction. Be sure not to cover it when wiring cords.

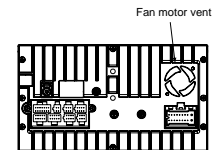
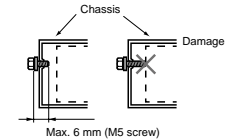
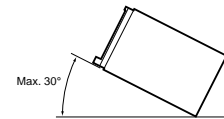

Installation Guide

Installing The Main Unit

This unit is designed for fixed installation in the dashboard.

- When installing the main unit in NISSAN vehicles, use the parts attached to the unit (see "■ NISSAN"). When installing the main unit in TOYOTA vehicles, use the parts attached to the vehicle (see "■ TOYOTA").
- Wire as shown in "Wire Connection".
- Reassemble and secure the unit in the dashboard and set the face panel and center panel.

Mounting Screw Holes (Side View of the Main Unit)

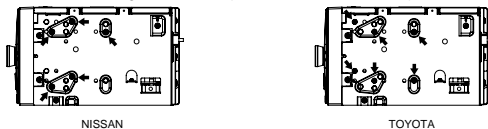

■ NISSAN

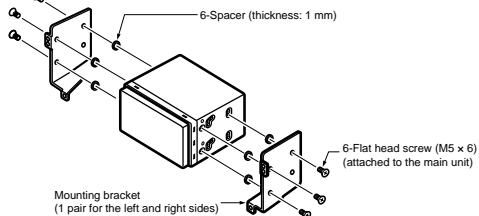

■ TOYOTA

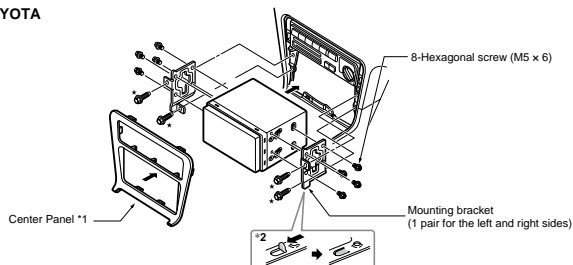

Screws marked ★ and mounting bracket are attached to the vehicle.

Installation Guide

Note:

*1 Some panel openings are too small for the unit depending on the vehicle type and model. In such a case, trim the upper and lower sides of the panel frame by about 0.5 to 1.5 mm so the unit can be inserted smoothly.

*2 If a hook on the installation bracket interferes with the unit, bend and flatten it with a nipper or similar tool.

■ Vehicles other than NISSAN and TOYOTA

In some cases the center panel may require modification. (Trimming, filling, etc.)

Typical Mounting Brackets

In some cases the center panel may require modification. (Trimming, filling, etc.)

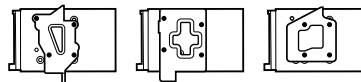

Example 1-3

Affix the screws to the ● marks.

Cautions On Wiring

- Be sure to turn the power off before wiring. Be particularly careful where you route the wires.
- Keep them well away from the engine, and exhaust pipe, etc. Heat may damage the wires.
- If the fuse should blow, check to see if the wiring is correct. If a fuse is blown, replace it with a new one of the same specification as the original.
- To replace the fuse, remove the old fuse of the power supply cord and insert the new one.

Note:

- There are various types of fuse holder. Do not let the battery side touch other metal parts.

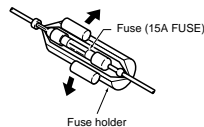

- After the connection, fix the cord by a clamp or insulation tape for protection.

Installation Guide

Installing The GPS Antenna

⚠ WARNING

- Do not install the GPS antenna in a place where it may interfere with the operation of the airbag or hinder the driver's visual range.
- Do not use the navigation system with the GPS antenna cord cut off. The power cables in the cord may be short-circuited.

Note:

- The supplied GPS antenna is for installing inside the vehicle. Do not install it outside the vehicle.
- Install the GPS antenna more than 50 cm away from the main unit, other audio devices such as CD player, and a radar detector. If it is installed near these devices, GPS reception may be impaired.
- To improve the GPS signal reception, install the GPS antenna horizontally on a flat plane.
- Do not wax or paint the cover of the GPS antenna. This may reduce the performance of the GPS antenna.
- Install the GPS antenna at least 10 cm away from the windshield.
- Wipe off the dirt of the mounting surface before installing the GPS antenna.

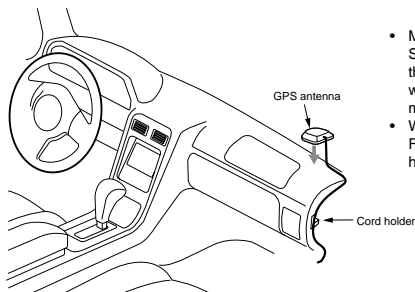

- Mount the GPS antenna. Stick it surely on a flat plane of the passengerside dashboard where GPS signal interruption is minimized.
- Wire the GPS antenna cord. Fasten the cord using the cord holders.

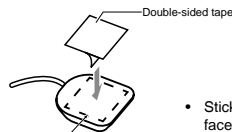

- Stick the double-sided tape to the bottom face of the GPS antenna.

Installation Guide

Wire Connection

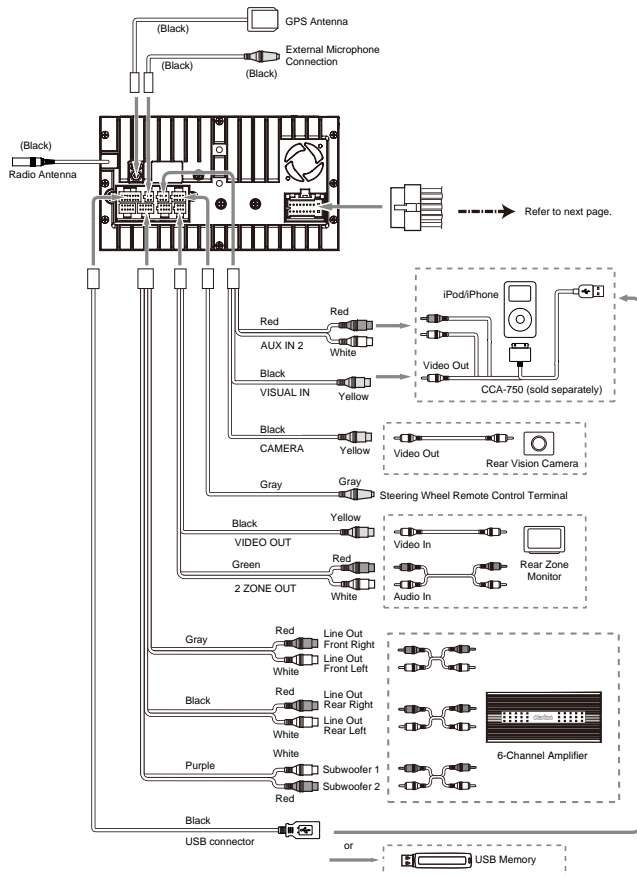

Installation Guide

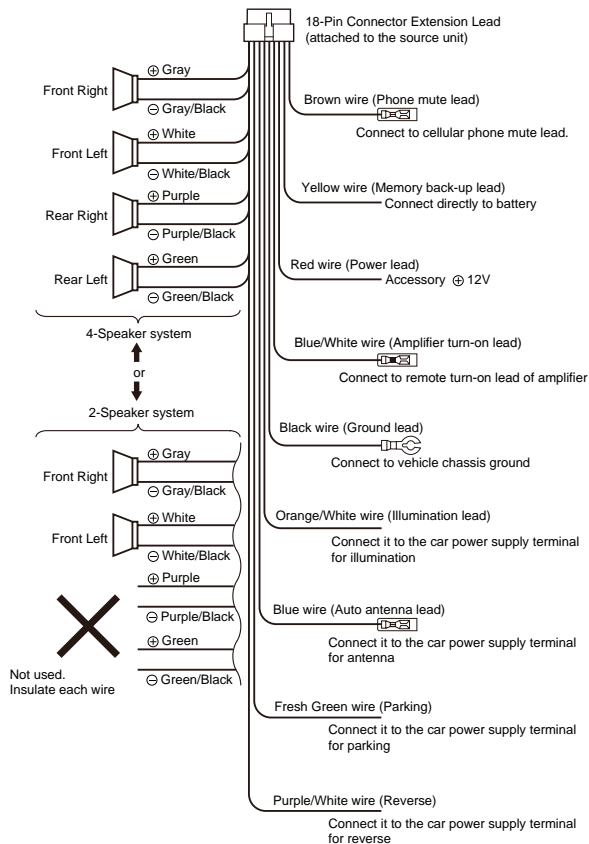

Installation Guide

Note:

- *1 Connect to the AUX audio input terminal and the iPod video input terminal. (Audio connection is required only when [Analog] is selected for the iPod output signal. See Owner's Manual.)
- *2 In certain vehicles - Volkswagen/Opel/Vauxhall - it is necessary to exchange the accessory <<Red>> and the main power <<Yellow>> connection, to avoid overload and loss of memory.
- *3 When the unit is installed in a 1998 or later Volkswagen model, make sure to interrupt the <<Remote>> output. Disconnect the <<blue/white>> wire and insulate the front ends of this cord. A breakdown may occur if the cord is not disconnected, or front ends are not insulated.

■ Connecting the parking brake cord

Connect the cord to parking brake lamp ground in the meter panel.

Note:

- Connecting the parking brake cord to lamp ground allows you to watch video images when the parking brake is engaged.
- When the parking brake is not connected, the monitor will not display video images.

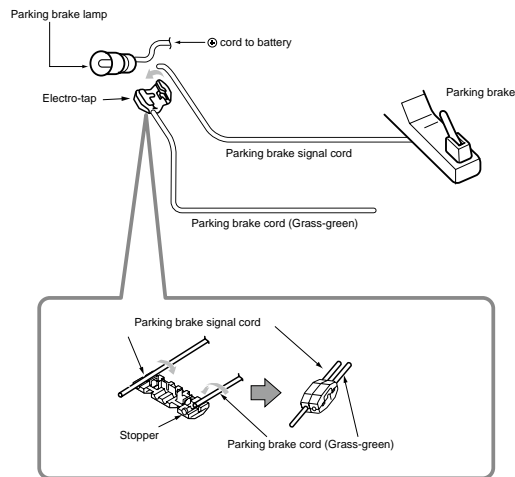

Clarion Co., Ltd.

All Rights Reserved. Copyright © 2012: Clarion Co., Ltd.
Printed in China/พิมพ์ในประเทศไทย/中国印制/Dicetak di Cina
PN: 127075004146