

clarion®

Owner's manual & Installation manual

คู่มือผู้ใช้ & คู่มือติดตั้ง

**Buku Petunjuk Penggunaan dan
Petunjuk Peningstalan**

NX509A

**2-DIN MEMORY NAVIGATION & DVD MULTIMEDIA STATION
WITH 7-inch TOUCH PANEL CONTROL**

ระบบนำทางและ DVD มัลติมีเดียสเตชันแบบ 2-DIN
พร้อมหน้าจอบควบคุมระบบสัมผัสขนาด 7 นิ้ว

**NAVIGASI MEMORI & STASIUN MULTIMEDIA DVD 2-DIN
DENGAN KONTROL PANEL SENTUH 7-inci**

Thank you for purchasing the Clarion **NX509A**.

- Please read this owner's manual thoroughly before operating this equipment.
- After reading this manual, be sure to keep it in a handy place (e.g., glove compartment).

Contents

1. FEATURES	2
Expanding Systems	2
Playable Discs	3
DVD Video Features	3
2. PRECAUTIONS	4
Operation Panel/Generalities	5
Cleaning	5
About the Registered Marks, etc.	6
3. CONTROLS	6
Functions of Buttons	6
Outline of Button and Touchkey Operation	8
Remote Control Unit	13
4. BASIC OPERATIONS	14
Turning On and Off the Power	14
Adjusting the Volume	15
Opening the Operation Panel and Adjusting the Angle	15
Turning the Audio OFF	16
Turning the Monitor OFF	17
Displaying the Clock Screen.....	17
Setting/Ejecting a Disc	17
Connecting/Disconnecting an USB Media Device.....	18
Selecting a Media Source	20
2-Zone Function	20
5. SOURCE OPERATIONS	21
Radio Operations	21
DVD Video Operations	23
Video CD Operations	29
Audio CD Operations	31
MP3/WMA/AAC Operations	32
DivX Operations	35
6. SOURCE OPERATIONS (ACCESSORIES)	38
iPod Operations	38
USB Memory Operations.....	42
Navigation System Operations.....	43
AUX Operations	43
7. SYSTEM SETTINGS	44
Audio Settings	44
General Settings.....	47
Adjusting the Monitor.....	50
8. TROUBLESHOOTING	52
9. ERROR DISPLAYS	54
10. SPECIFICATIONS	56
INSTALLATION AND WIRE CONNECTION MANUAL	57

1. FEATURES



- USB Direct Connection for iPod®
- All-in-one AV & Navigation unit with Touch Panel control
- Sirf III GPS module with 20-channel receiver

Expanding Systems

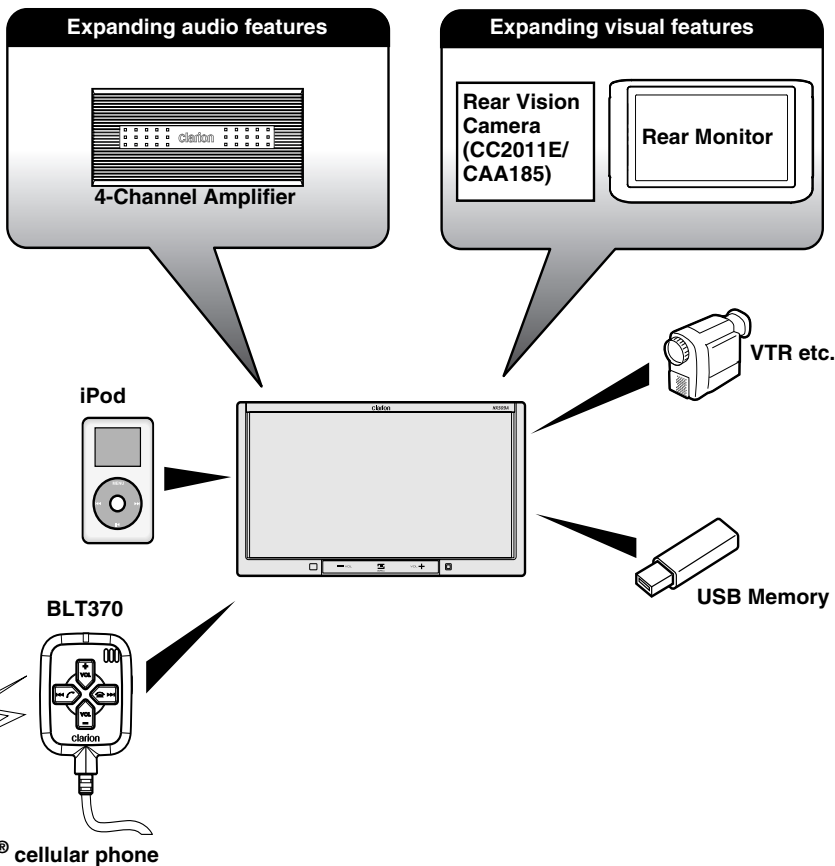

Note:
The items listed outside of the frames are the commercial products generally sold.

Playable Discs

This DVD player can play the following discs:

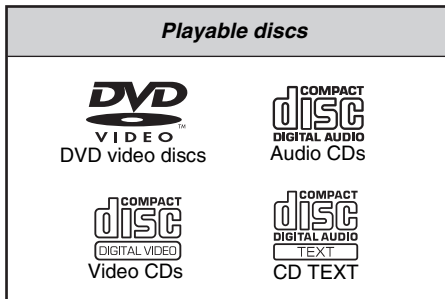

In addition, the DVD player can play CD-R/RW, DVD-R/RW, and DVD+R/RW discs on which the following media files have been recorded:

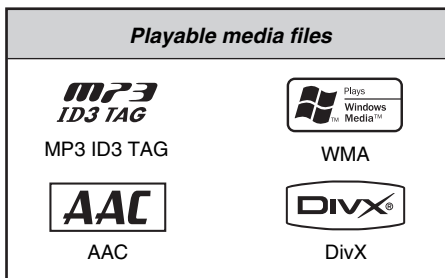

For detailed information, see the sections entitled "MP3/WMA/AAC Operations" (page 32) and "DivX Operations" (page 35).

About CD Extra discs

A CD Extra disc is a disc in which a total of two sessions have been recorded. The first session is Audio session and the second session is Data session.

Your personally-created CDs with more than second data sessions recorded cannot be played on this DVD player.

Note:

- When you play a CD Extra disc, only the first session will be recognized.

About playing a CD-R/RW disc

This player can play CD-R/RW discs previously recorded in Video CD, Audio CD format, or format with MP3/WMA/AAC/DivX files.

About playing a DVD-R/RW or DVD+R/RW disc

This player can play DVD-R/RW and DVD+R/RW discs previously recorded in DVD video format or format with MP3/WMA/AAC/DivX files.

Discs that cannot be played back

This player cannot play DVD Audio, DVD-RAM, Photo CDs, etc.

Note:

- It may not be possible to play back discs recorded on some CD/DVD drive units. (Cause: disc characteristics, cracks, dust/dirt, dust/dirt on player's lens, etc.)
- If a CD-R/RW, DVD-R/RW, or DVD+R/RW disc that has not been finalized is played, it will take a long time to start playing. Also, it may not be possible to play depending on its recording conditions.
- You cannot play Super Audio CDs. Playback of the CD player is not supported even if it is a hybrid disc.

Note on region numbers of DVD video discs

The DVD video system assigns a region number to DVD players and DVD discs by sales area. The DVD video region number playable in this system is marked on the disc jacket as shown below.



DVD Video Features

This unit provides the following functions in addition to the high image quality and sound quality of DVD video.

Note:

- The functions described in this section differ depending on the DVD video disc. Refer to the instructions provided with the DVD video.
- Some disc functions may operate differently from described in this manual.

Multi-sound function

DVD video can store up to 8 languages for one film; select the language of your preference.

- The languages stored on the disc are indicated by the icon shown below.



Multi-angle function

A DVD video that is filmed from multiple angles allows you to select the angle of choice.

- The number of recorded angles is indicated by the icon shown below.

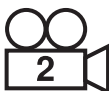

Subpicture (subtitles) function

A DVD video can record subtitles for up to 32 languages and you can select the language of the subtitles you wish to see.

- The number of recorded subtitle languages is indicated by the icon shown below.



Multi-story function

When a DVD video contains more than one story for a film, you can select the story you wish to enjoy. The operation procedures vary with the disc; observe the instructions for selecting a story provided during playback.

DVD menu

DVD Menus can be called up during DVD video playback to perform menu setting.

- Example showing DVD menu



2. PRECAUTIONS

⚠ WARNING

For your safety, the driver should not watch the DVD video/movie data or operate the controls while driving. Please note that watching and operating the DVD video/movie data while driving are prohibited by law in some countries. Also, while driving, keep the volume to a level at which external sounds can be heard.

- When the inside of the car is very cold and the player is used soon after switching on the heater, moisture may form on the disc (DVD/CD) or the optical parts of the player and proper playback may not be possible. If moisture forms on the disc (DVD/CD), wipe it off with a soft cloth. If moisture forms on the optical parts of the player, do not use the player for about one hour. The condensation will disappear naturally allowing normal operation.
- Driving on extremely bumpy roads which cause severe vibration may cause the sound to skip.
- This unit uses a precision mechanism. Even in the event that trouble arises, never open the case, disassemble the unit, or lubricate the rotating parts.

Operation Panel/ Generalities

For a longer service life, be sure to read the following cautions.

- Be sure to house the operation panel inside the main unit when parking the car outdoors for a long period of time. The operation panel will operate properly in a temperature range of 0 to 60°C.
- Do not allow any liquids on the set from drinks, umbrellas, etc. Doing so may damage the internal circuitry.
- Do not disassemble or modify the set in any way. Doing so may result in damage.
- Do not draw the operation panel out and use it as a tray. Also, subjecting the operation panel to shocks may result in breakage, deformation, or other damage.
- Do not let cigarettes burn the display. Doing so may damage or deform the cabinet.
- If a problem should occur, have the set inspected at your store of purchase.
- Do not insert objects or poke in the space between the operation panel and the main unit when the panel is tilted.
- Do not place anything on the display when the panel is tilted.

- The remote control unit may not work if the remote control sensor is exposed to direct sunlight.
- In extremely cold weather, the display movement may slow down and the display may darken, but this is not a malfunction. The display will work normally when the temperature increases.
- Small black and shiny spots inside the operation panel are normal for LCD products.
- The operation panel may stop temporarily when it opens or closes, when the engine stops or when it is cold.
- The touchkeys on the display operate when slightly touched. Do not press the touchkey screen with much force.
- Do not push the case surrounding the touchkey panel with much force. This may cause malfunctioning of the touchkeys.

Cleaning

• **Cleaning the cabinet**

Use a soft and dry cloth and gently wipe off the dirt. For tough dirt, apply some neutral detergent diluted in water to a soft cloth, wipe off the dirt gently, then wipe again with a dry cloth.

Do not use benzene, thinner, car cleaner, etc., as these substances may damage the cabinet or cause the paint to peel. Also, leaving rubber or plastic products in contact with the cabinet for long periods of time may cause stains.

• **Cleaning the operation panel**

The operation panel tends to collect dust, so wipe it off occasionally with a soft cloth. The surface is easily scratched, so do not rub it with hard objects.

About the Registered Marks, etc.

- This product incorporates copyright protection technology that is protected by U.S. patents and other intellectual property rights. Use of this copyright protection technology must be authorized by Macrovision, and is intended for home and other limited viewing uses only unless otherwise authorized by Macrovision. Reverse engineering or disassembly is prohibited.
- Manufactured under license from Dolby Laboratories.
“Dolby” and the double-D symbol are trademarks of Dolby Laboratories.
- Windows Media™, and the Windows® logo are trademarks, or registered trademarks of Microsoft Corporation in the United States and/or other countries.
- “DivX”, “DivX Certified”, and associated logos are trademarks of DivX, Inc., and are used under license.
- “Made for iPod” means that an electronic accessory has been designed to connect specifically to iPod and has been certified by the developer to meet Apple performance standards.
Apple is not responsible for the operation of this device or its compliance with safety and regulatory standards.
iPod is a trademark of Apple Inc., registered in the U.S. and other countries.
- BBE MP (Minimized Polynomial Non-Linear Saturation) Process improves digitally compressed sound, such as MP3, by restoring and enhancing the harmonics lost through compression. BBE MP works by regenerating harmonics from the source material, effectively recovering warmth, details and nuance.
- Manufactured under license from BBE Sound, Inc.
- Licensed by BBE Sound, Inc. under one or more of the following US patents: 5510752, 5736897. BBE and BBE symbol are registered trademarks of BBE Sound, Inc.

3. CONTROLS

● Operation Panel

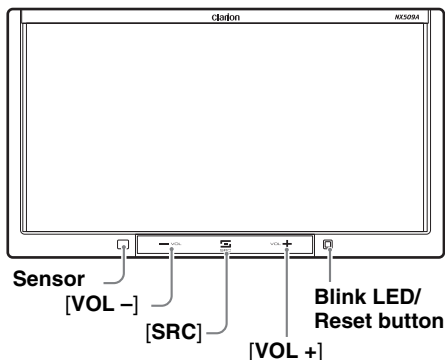

● With the operation panel open

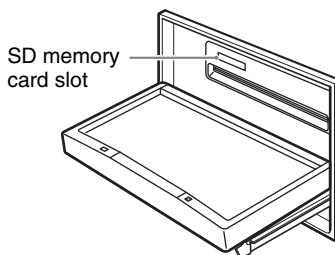

Functions of Buttons

Note:

- Be sure to read this section while referring to the front diagram.

Sensor

- Receiver for the remote control unit (operating range: 30° in all directions).

[VOL -], [VOL +] buttons

- Use these buttons to increase/decrease the volume.

[SRC] button

- Press this button to display/hide the Source screen to switch the source mode.

Blink LED

- When the Blink LED function is set to “On” from the System tab menu on the General screen, blinks when the ACC power is turned off.

SD memory card slot

- SD memory card function is available in the Navi mode. For more information about the SD memory card function, see your User Manual (for the Navi mode).

Note:

- *When you insert the SD memory card stored music files, they cannot be read in this unit.*

Outline of Button and Touchkey Operation

Turning the power on

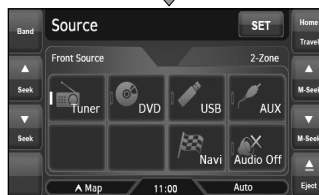
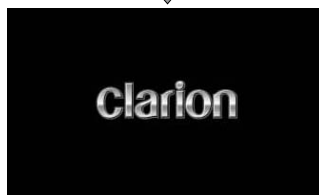
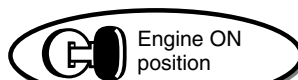
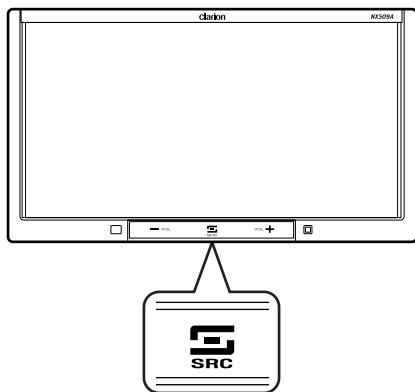

You can change the media sources.

System check

The CeNET format utilized on this unit is provided with a system check function. When the system check function is performed under the following conditions, the power is automatically turned off. Once turn off the engine switch, then restart the engine again.

- When power is first turned on after initial installation.
 - When an external device is connected or disconnected.
 - When Reset button is pressed.
- * In addition to the above conditions, the system check function can be performed from the System tab menu on the General screen.

Note:

- *1 These images indicate the buttons to press or keys to touch.

Tuner mode operation

(Source screen)

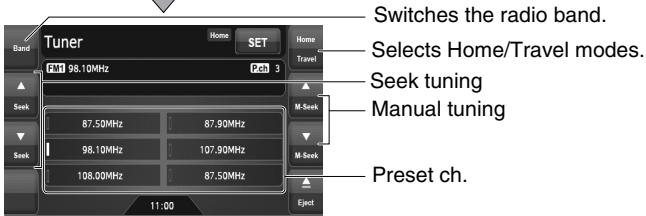

- Select desired station after selecting radio band.

DVD Video mode operation

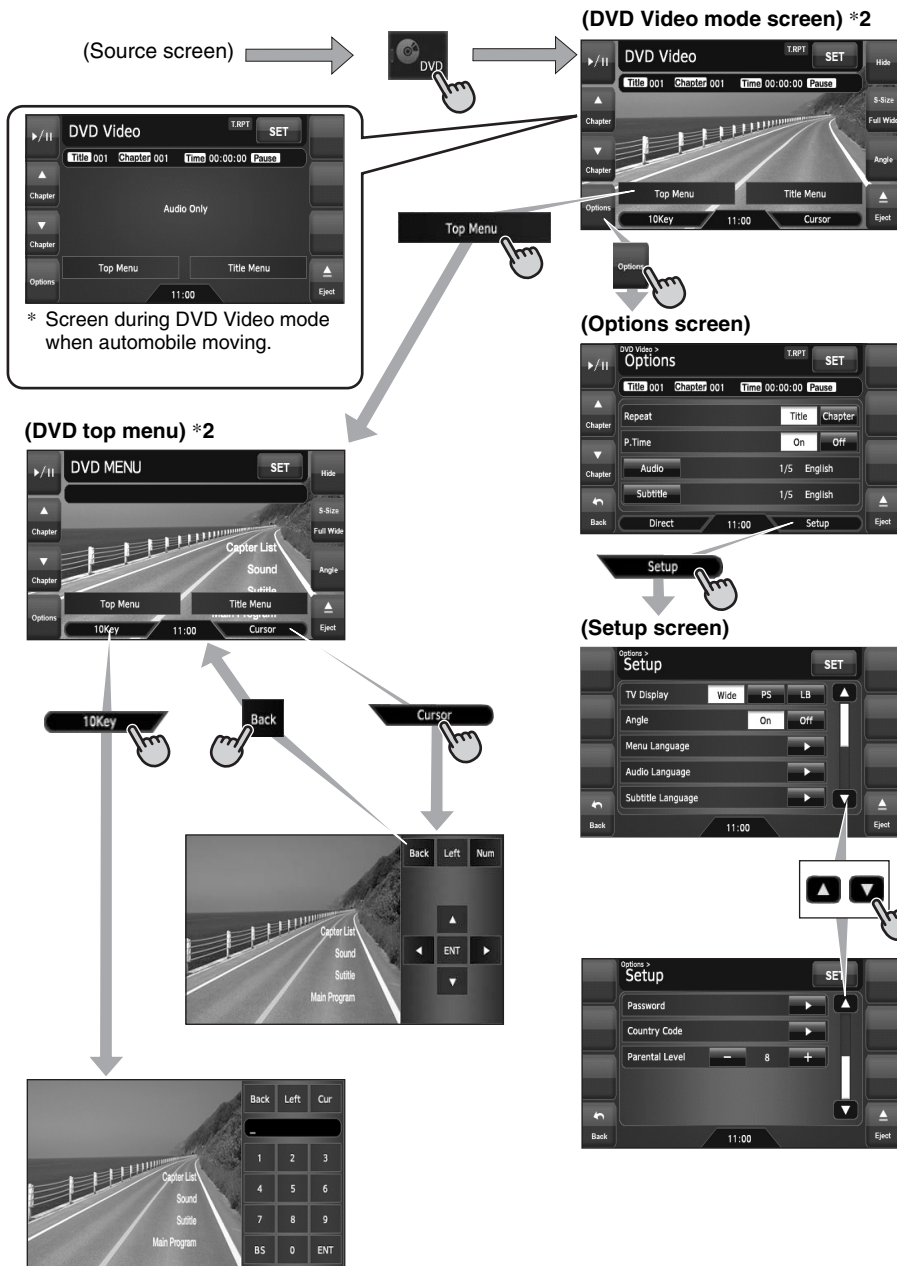

Note:

*2 If you do not touch the screen for about 7 seconds, all the keys on the screen will disappear. Touch the screen surface to redisplay them.

Adjusting the General settings

(Source or Mode screen)



(Settings screen)

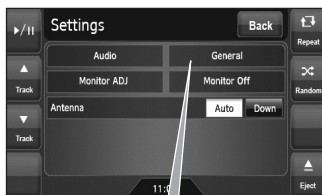

(General screen)

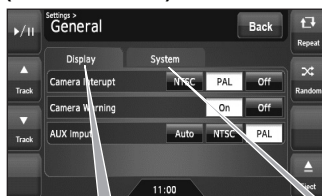

(Display tab screen)

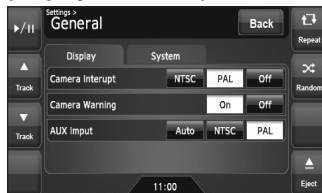

(System tab screen)

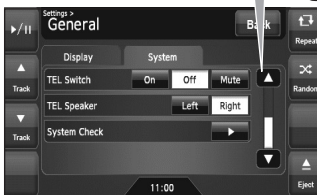
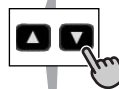
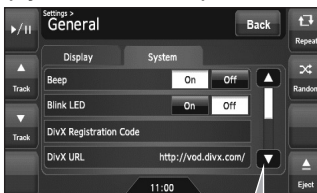

Adjusting the Audio settings

(Source or Mode screen)



(Settings screen)

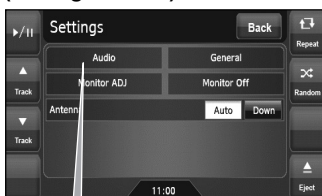

(Audio screen)

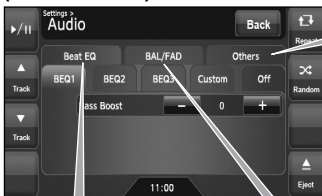

(Others tab screen)



(Beat EQ tab screen)

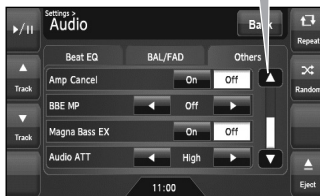

(BAL/FAD tab screen)

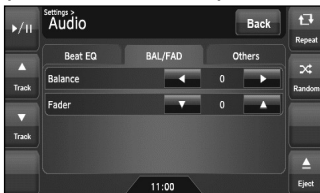

Names of buttons

Signal transmitter

Operating range: 30° in all directions

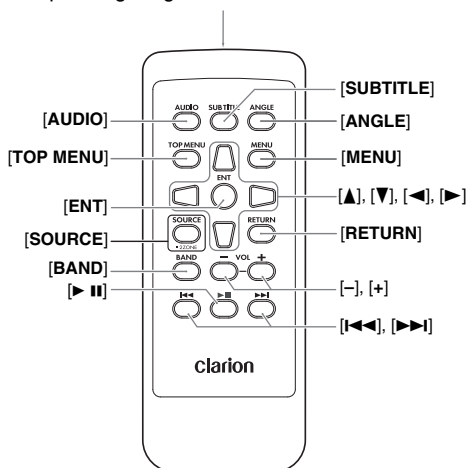

Inserting the Battery

1. Slide the rear cover in the direction of the arrow, and remove it.
2. Insert the CR2025 battery bundled with the remote control unit in the directions shown in the figure, then close the rear cover.

Note:

Using battery improperly can cause it to explode.

Take note of the following points:

- Do not short-circuit, disassemble or heat battery.
- Do not dispose of battery into fire or flames.
- Dispose of spent battery properly.

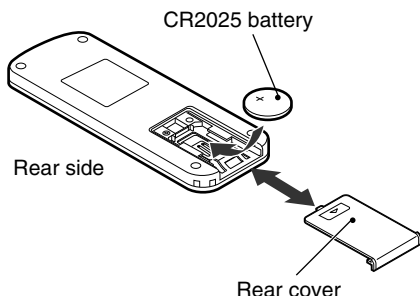

Functions of Remote Control Unit Buttons

You can use the remote control unit to control the NX509A. When the 2-Zone function is ON, the controls work upon the Sub zone only.

Note:

- The steering wheel remote control operations work upon the Main zone even when the 2-Zone function is ON.

[AUDIO] button

- Press to set the Audio language. (in DVD Video and DivX modes)
- Press to change the Audio Channel mode. (in Video CD mode)

[SUBTITLE] button

- Press to display subtitles. (in DVD Video and DivX modes)

[ANGLE] button

- Press to switch among the angles when DVD video discs recorded in multiple angles are played back.

[TOP MENU] button

- Press to display the DVD top menu stored on the DVD video disc. Some discs are not displayed the DVD top menu. (in DVD Video mode)

[MENU] button

- Press to display the DVD menu stored on the DVD video disc. (in DVD Video mode)
- Press to display the Video CD menu stored on the Video CD. (in Video CD mode)

[ENT] button

- Press to fix the selected menu item on the DVD menu. (in DVD Video mode)

[▲], [▼], [◀], [▶] buttons

- Press to select desired menu item displayed on the DVD menu. (in DVD Video mode)

[SOURCE] button

- Press to switch the source modes such as Tuner mode, DVD mode, etc. (in any mode)
 - * Only DVD, USB, and AUX modes are selectable when 2-Zone ON.
- Keep pressing more than 1 second to turn the 2-Zone function ON/OFF. (in any mode)

[RETURN] button

- Press to return to the previous screen while the DVD or Video CD menu is being displayed. However, it may occur that this button operation does not work on some discs. (in DVD Video and Video CD modes)

[BAND] button

- Switches reception bands. (in Tuner mode; disabled when 2-Zone ON)
- Keep pressing more than 1 second to switch the Home/Travel modes. (in Tuner mode; disabled when 2-Zone ON)
- Press to select the next higher folder. (in MP3/WMA/AAC/DivX and USB memory modes)

[VOL -], [VOL +] buttons

- Decreases or increases the volume. (in any mode; disabled when 2-Zone ON)

[▶ II] button

- Press to play or pause video and audio media. (in DVD and USB modes; disabled in USB mode when 2-Zone ON)
- Keep pressing more than 1 second to stop video playback. (in DVD Video mode)

[◀◀], [▶▶] buttons

- Press to select the next lower or higher preset station. (in Tuner mode; disabled when 2-Zone ON)
- Press to select the next lower or higher chapter number. (in DVD Video mode)
- Press to select the next lower or higher track. (in Video CD, CDDA, MP3/WMA/AAC/DivX, and USB modes)
- Keep pressing to perform fast backward or fast forward playback. (in DVD and USB modes)

4. BASIC OPERATIONS

Note:

- Be sure to read this chapter referring to the chapter "3. CONTROLS" (page 6).

Turning On and Off the Power

CAUTION

When the unit is turned on, starting and stopping the engine with its volume raised to the maximum level may harm your hearings. Be careful about adjusting the volume.

Note:

- Start the engine before using this unit.
 - Be careful about using this unit for a long time without running the engine. If you drain the car's battery too far, you may not be able to start the engine and this can reduce the service life of the battery.
1. Start the engine. The power is supplied to this unit.



Engine ON
position

The unit automatically memorizes its last operation mode and will automatically switch to display that mode.

2. To turn off the power, turn off the engine switch.

● About the CT (Clock Time) display

- The displayed clock data is based on the CT (clock time) data in the Navigation system.
- When the CT data cannot be received, "--:--" appears in the display.

Adjusting the Volume

1. Press the [VOL -]/[VOL +] buttons to adjust the volume.
 - [VOL -]: Decreases the volume.
 - [VOL +]: Increases the volume.
 - The volume level indicated in the display is in a range from 0 (min.) to 33 (max.).

⚠ CAUTION

While driving, keep the volume level at which external sounds can be heard.

Opening the Operation Panel and Adjusting the Angle

The operation panel can be opened/closed to insert/eject a disc. The angle of the operation panel can be adjusted depending on the mounting angle of the unit or light coming into the car.

⚠ WARNING

- To prevent the battery from going dead, operate this unit with the engine running if possible.
- When the operation panel is operating, be careful not to get your hand or finger caught between the panel and main unit or the instrument panel of the car.
- Do not move the operation panel by hand.

Opening/closing the operation panel

1. Touch the [▲ (Eject)] key to display the following Eject screen:

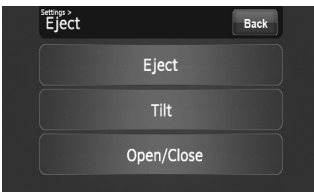

2. Touch the [Open/Close] key. The operation panel will be opened.

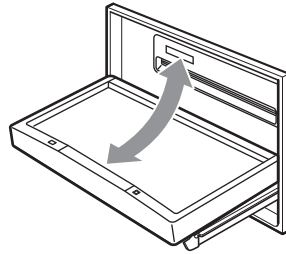

3. Touch the [Open/Close] key when the operation panel is open. The operation panel will be closed.
 - The operation panel will close automatically when leaving it open for a while.
4. Touch the [Back] key to return to the previous screen.

Adjusting the angle of the operation panel

The angle of the operation panel can be adjusted in the range of 0° to 30°

1. Touch the [**Eject**] key to display the Eject screen.
2. Repeat touching the [**Tilt**] key to adjust the angle of the operation panel. Every touching the [**Tilt**] key tilts the operation panel forward or backward.
The adjusted angle is stored in memory.
Once you adjust the angle of the operation panel, the operation panel will return to the adjusted angle even after it is opened/closed.

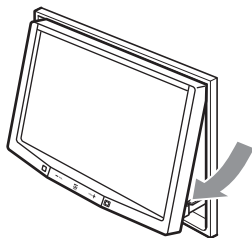

3. When the adjustment is finished, touch the [**Back**] key to return to the previous screen.

Returning the operation panel to the original angle

1. Touch and hold the [**Tilt**] key.
The operation panel will move and stop at 30°.
2. Touch and hold the [**Tilt**] key again.
The operation panel will move and stop at 0°.

Turning the Audio OFF

You can turn off all of the AV features.

1. Press the [**SRC**] button to display the Source screen.
2. Touch the [**Audio Off**] key.
The AV features are turned off.

Turning the AV features on

1. Press the [**SRC**] button to display the Source screen.
2. Touch the desired Source key.
The AV features are turned on, and the system enters into the specified mode.

Turning the Monitor OFF

You can turn off the monitor screen, and change it to a black screen.

1. Touch the **[SET]** key to display the Settings screen.
2. Touch the **[Monitor Off]** key.
The monitor screen is turned off.

Turning the monitor on

1. Touch the monitor screen.
The monitor screen is turned on, and resumes the last screen.
 - You can also turn on the monitor by pressing the **[SRC]** button.

Displaying the Clock Screen

You can change the screen to display only the digital clock on a black screen.

1. Touch the clock display on most screens.
The Clock screen is displayed.
2. To return to the current mode screen, touch the monitor screen.
 - Pressing the **[SRC]** button displays the Source screen.

Setting/Ejecting a Disc

□ Notes on handling discs

Handling

- New discs may have some roughness around the edges. If such discs are used, the player may not work or the sound may skip. Use a ball-point pen or the like to remove any roughness from the edge of the disc.

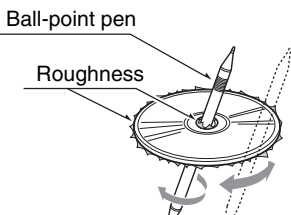

- Never stick labels on the surface of the disc or mark the surface with a pencil or pen.
- Never play a disc with any cellophane tape or other glue on it or with peeling off marks. If you try to play such a disc, you may not be able to get it back out of the DVD player or it may damage the DVD player.
- Do not use discs that have large scratches, are misshapen, cracked, etc. Use of such discs may cause misoperation or damage.
- To remove a disc from its storage case, press down on the center of the case and lift the disc out, holding it carefully by the edges.
- Do not use commercially available disc protection sheets or discs equipped with stabilizers, etc. These may damage the disc or cause breakdown of the internal mechanism.

Storage

- Do not expose discs to direct sunlight or any heat source.
- Do not expose discs to excess humidity or dust.
- Do not expose discs to direct heat from heaters.

Cleaning

- To remove fingermarks and dust, use a soft cloth and wipe in a straight line from the center of the disc to the circumference.
- Do not use any solvents, such as commercially available cleaners, anti-static spray, or thinner to clean discs.
- After using special disc cleaner, let the disc dry off well before playing it.

On Discs

- Exercise a good precaution when loading a disc with the panel open.
- Never turn off the power and remove the unit from the car with a disc loaded.
- Do not use lens cleaning discs. These may damage the lens of this unit.
- When there seems to be something wrong with reading discs, please consult your dealer or an authorized Clarion service center.

❑ **Setting a disc**

1. Touch the [**Eject**] key to display the Eject screen.
2. Touch the [**Open/Close**] key.
The operation panel will be opened.
3. Insert a disc into the center of the insertion slot with the label side facing up.
The disc will automatically be drawn into the DVD player.

After setting a disc

The system will automatically be switched to the relevant source media mode according to the disc, and start playing back the disc.

When a DVD video disc is set:

The system is switched to the DVD Video mode. See "DVD Video Operations" (page 23).

When a Video CD is set:

The system is switched to the Video CD mode. See "Video CD Operations" (page 29)

When an Audio CD is set:

The system is switched to the CDDA mode. See "Audio CD Operations" (page 31).

When a CD/DVD with MP3/WMA/AAC/DivX files is set:

The system is switched to the MP3/WMA/AAC mode or DivX mode according to the Playform setting. See "MP3/WMA/AAC Operations" (page 32) or "DivX Operations" (page 35).

Note:

- Never insert foreign objects into the disc insertion slot.
- If the disc is not inserted easily, there may be another disc in the mechanism or the unit may require service.
- 8 cm (single play) discs cannot be used.

⚠ CAUTION

For your safety, the driver should not insert or eject a disc while driving.

❑ **Ejecting a disc**

1. Touch the [**Eject**] key to display the Eject screen.
2. Touch the [**Eject**] key to eject the disc.
The operation panel will be opened and the disc will be ejected.
 - If a disc is left in the ejected position for 15 seconds, the disc is automatically reloaded (Auto reload).
3. Remove the disc carefully.
4. Touch the [**Open/Close**] key to close the operation panel.
 - The operation panel will close automatically when leaving it open for a while.

5. Touch the [**Back**] key.

Note:

- If you force a disc into the insertion slot before auto reloading, this can damage the disc.

Connecting/Disconnecting an USB Media Device

This unit has one USB (Universal Serial Bus) connector which is compatible with USB 1.1 and USB 2.0.

❑ **Playable USB media devices**

This system can control the following USB media devices connected to the USB connector.

- Apple iPod
- USB memory

About the Apple iPod

iPods can be connected by using the connector cable supplied with the iPod you use, but in this case, you can enjoy its audio sound only. To enjoy video movies stored in the iPod with video displaying them on this unit, it is required to use the special connector cable separately sold.

Note:

- This system will not operate or may operate improperly with unsupported versions.
- For detailed information on the playable iPod models, see our home page: www.clarion.com
- For the other limitations, see "iPod Operations" (page 38).

About the USB memory

This system can play audio files (MP3/WMA/AAC) stored in an USB memory which is recognized as "USB Mass Storage Class device". You can use your USB memory as an audio device by simply copying desired audio files into it.

Note:

- This system will not operate or may operate improperly with some USB memory.
- Files protected with any DRM can not be played.
- For the other limitations, see "USB Memory Operations" (page 42).

❑ Connecting an USB media device

⚠ CAUTION

- For your safety, the driver should not connect or disconnect an USB media device.
 - Do not start the vehicle's engine while the USB media device is connected, since it may result in loss or damage to data on the USB media device. Connect the USB media device to this unit after starting the engine.
1. Turn on the power of your USB media device, if required.
 2. Confirming the orientation of the connectors, connect the USB media device to the USB connector of this unit.
 - It may take a long time to recognize the connected device.

After connecting an USB device

The system will automatically be switched to the relevant source media mode according to the USB device connected, and start playback.

When an iPod is connected:

The system is switched to the iPod mode. See "iPod Operations" (page 38).

When an USB memory is connected:

The system is switched to the USB Memory mode. See "USB Memory Operations" (page 42).

Note:

- Never insert foreign objects into the USB connector.
- Always insert the USB media device fully into the connector. Incomplete connections may cause the device not to be recognized.

❑ Disconnecting an USB media device

1. Confirm that data transfer is not performed on the USB media device.
For the method to confirm it, see the operation manual of your USB media device.
2. Remove the USB media device from the USB connector.

⚠ CAUTION

Be sure to disconnect the USB media device while the vehicle's engine is running. Otherwise, it may result in loss or damage to data on the USB media device. Do not stop the engine when the USB media device is connected.

Note:

- When turning on the ACC power with no USB media device connected, "No Media" may be displayed on the screen if the USB mode is selected.

Selecting a Media Source

Changing the source mode

1. Press the [SRC] button to display the Source screen.

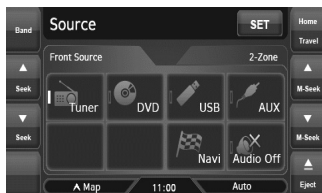

2. Touch the desired Source key you wish to change to.
The system is switched to the corresponding source media mode.

Available media sources

Source mode	Corresponding source media mode	Refer to
Tuner mode	Tuner mode	page 21
DVD mode* ¹	DVD Video mode	page 23
	Video CD mode	page 29
	CDDA mode	page 31
	MP3/WMA/AAC mode	page 32
	DivX mode	page 35
USB mode* ²	iPod mode	page 38
	USB Memory mode	page 42
AUX mode	AUX mode	page 43
Navi mode	Navi mode	page 43

*1: The source media mode to be selected differs depending on the data format of the disc set in the DVD player. When no disc is set, "No Disc" will be displayed.

*2: The source media mode to be selected differs depending on the type of the USB media device connected. When no USB media device is connected, "No Media" will be displayed.

Note:

- When the USB mode is selected, video images input from the AUX1 terminal will be output to the rear monitor. This is normal.

2-Zone Function

About the 2-Zone function

The 2-Zone function is a function that assigns separate source output to the Main zone (this unit) and Sub zone (the optional rear monitor) by simultaneously playing two sources in this system. Therefore, the rear passengers are allowed to enjoy a different video source from the source played on the operation panel of this unit.

- The source sounds of the Main zone are output from the speakers of the vehicle side, and those of the Sub zone are from the optional headphone systems.
- Controlling a source assigned to the Sub zone can be made by using the optional remote control unit. To control it from this unit, once assign the same source to the Main zone, then control it.
- When a media without video images is played on the Sub zone, a black screen is output to the rear monitor.

Note:

- When an interrupt of the navigation system arises during the 2-Zone function is turned on, the sound of the Main zone is muted, but the sound of the Sub zone is output normally.
- When it arises during the 2-Zone function is turned off, the audio signals to the 4ch speakers are attenuated, and the voice from the navigation system is output from the front two speakers.
- You cannot operate the 2-Zone function during the interrupt of the navigation system.
- When the same source is assigned for Main and Sub zones, operations in a zone are also applied for another zone.

Assignable source mode for Main/Sub zones

● For Main zone

All the source modes can be assigned for the Front zone.

● For Sub zone

The following source modes can be assigned:

- DVD mode
- USB mode
- AUX1 mode

Note:

- The AUX2 mode cannot be assigned for the Sub zone.

Setting the 2-Zone function

- The factory default setting is OFF.

1. Press the [SRC] button to display the Source screen.
2. Touch the [2-Zone] tab to display the 2-Zone tab screen.
The source keys for the Sub zone are displayed.

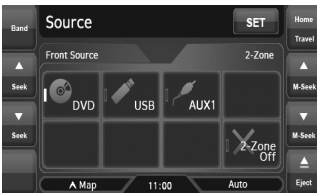

3. Touch the desired source key you wish to assign to the Sub zone.
The 2-Zone function is turned on with the selected source mode assigned to the Sub zone.
4. Touch the [Back] key to return to the previous screen.

Note:

- Use the remote control unit to control the source assigned to the Sub zone. To control it from this unit, once select the same source mode as assigned to the Sub zone for the Main zone, and then control it.

Turning off the 2-Zone function

1. Press the [SRC] button to display the Source screen.
2. Touch the [2-Zone] tab to display the 2-Zone tab screen.
3. Touch and hold the [2-Zone Off] key for more than 1 second.

5. SOURCE OPERATIONS

Radio Operations

Listening to the radio

1. Press the [SRC] button, and touch the [Tuner] key.

The Tuner mode screen is displayed, and the system resumes the last status of the Tuner mode.

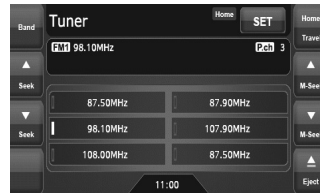

2. Touch the [Home Travel] key to select the Home or Travel mode.
The Home/Travel modes are provided to manage the preset stations separately in your home location and in a location during a trip.
3. Touch the [Band] key to select the radio band. Each time the key is touched, the radio reception band changes in the following order:
 - In Home mode: FM Home 1 → FM Home 2 → AM Home → FM Home 1...
 - In Travel mode: FM Travel → AM Travel → FM Travel...
4. Touch the desired Preset key to tune in the corresponding preset station.

Seek tuning

1. Touch the **[Band]** key to select the desired band (FM or AM).
2. Touch the **[▲ (Seek)]** or **[▼ (Seek)]** key to automatically seek a station.
 - When touching the **[▲ (Seek)]** key, the station is sought in the direction of higher frequencies.
 - When touching the **[▼ (Seek)]** key, the station is sought in the direction of lower frequencies.

Manual tuning

There are 2 ways available: Quick tuning and step tuning.

When it is in the step tuning mode, the frequency changes one step at a time. In quick tuning mode, you can quickly tune the desired frequency.

1. Touch the **[Band]** key to select the desired band (FM or AM).
2. Tune into a station.

Quick tuning:

Touch and hold the **[▲ (M-Seek)]** or **[▼ (M-Seek)]** key to tune in a station.

Step tuning:

Touch the **[▲ (M-Seek)]** or **[▼ (M-Seek)]** key to manually tune in a station.

Recalling a preset station

There are total of 30 preset positions (6-FM Home 1, 6-FM Home 2, 6-AM Home, 6-FM Travel, and 6-AM Travel) to store individual radio stations in memory.

1. Touch the **[Home Travel]** key to select the Home or Travel mode.
2. Touch the **[Band]** key to select the band.
3. Touch the corresponding Preset key to recall the stored station.
 - Touching and holding the desired Preset key for more than 2 seconds will store the current station to the preset memory.

Manual memory

1. Touch the **[Home Travel]** key to select the Home or Travel mode.
2. Touch the **[Band]** key to select the band you wish to store.
3. Tune in the station you wish to store using the seek tuning, manual tuning, or preset tuning.
4. Touch and hold the desired Preset key you wish to store the current station for more than 2 seconds.

Auto Store

The Auto Store is a function for storing up to 6 stations that are automatically tuned in sequentially. If 6 receivable stations cannot be received, a previously stored station remains unoverwritten at the memory position.

- The Auto Store function works only in the Travel mode.
1. Touch the **[Home Travel]** key to select the Travel mode.
 2. Touch the **[Band]** key to select the band.
 3. Touch the **[Auto Store]** key to start scanning stations.

A beep sounds and the stations with good reception are stored automatically to the preset channels.

- "AS" appears during scanning stations. To stop the scanning, touch the **[Auto Store]** key again.

❑ Selecting the DVD Video mode

1. Set a DVD video disc to the DVD player.
The system will automatically read the disc data, change to the DVD mode (DVD Video mode), and start playback after a while. See also “Setting/Ejecting a Disc” (page 17).



⚠ WARNING

- Some videos may be recorded at a higher volume level than desired. Increase the volume gradually from the minimal setting after the video has started.
- For your safety, the driver should not watch the video or operate the controls while driving. Please note that watching and operating the video while driving are prohibited by law in some countries.

Note:

- For your safety, this system has a safety function which turns off the picture when the car is moving, so only the audio can be heard. The picture can only be watched when the car is stopped and the parking brake is applied.
- If “Audio Only” appears on the screen just after turning on the ACC power of the car, release the parking brake while confirming safety, and then engage the parking brake again.

● When a DVD video disc is already set

1. Press the [SRC] button to display the Source screen.
2. Touch the [DVD] key to select the DVD Video mode.
The system changes to the DVD mode (DVD Video mode), and starts playback from the previous position.

❑ Changing the DVD System Settings

Note:

- If the Setup operation is performed in the middle of DVD video play, the disc will restart from beginning.

Displaying the DVD Setup screen

1. Touch the screen to display the DVD Video mode screen.
2. Touch the [Options] key to display the Options menu.
3. Touch the [Setup] key to display the Setup screen.



- Touch the [▼] key to display the next page.
- Touch the [▲] key to return to the previous page.

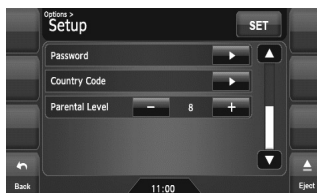

4. Perform setting for the desired setting items. See the following sections for detail.
 - In the following sections, only the details of settings are described, the procedures to select items are skipped.
5. Touch the [Back] key.

Setting up the screen size

Set up the screen size according to the optional rear monitor which is connected to this unit.

- The factory default setting is “Wide”.
- 4-1. Touch the [Wide], [PS], or [LB] key of the TV Display item to change the screen size to “Wide”, “Pan Scan” or “Letter Box”.

● **When watching through a wide type of the rear monitor (16:9)**

Wide:

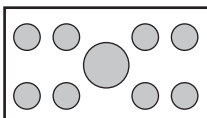

● **When watching through a conventional type of the rear monitor (4:3)**

Pan Scan:

The leftmost and rightmost areas of the screen are cut off.

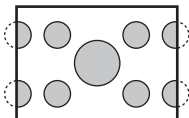

This function allows displaying the important part of image fully on the screen. In some cases, image is displayed while being panned (scrolled).

Letter Box:

A black zone is created in the top and bottom areas of the screen.

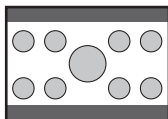

This method displays Cinema Scope and Vista Vision images without cutting them off by creating a black zone on the top and bottom gaps.

Setting up the angle mark display

You can set up so that the angle mark appears on scenes where the angles can be switched.

- The factory default setting is "Off".

- 4-1. Touch the [On] or [Off] key of the Angle item to turn the Angle function ON or OFF.

Setting up the disc menu language

- The factory default setting is "English".

- 4-1. Touch the [▶] key of the Menu Language item.
- 4-2. Touch the desired Language key you wish to set.
- 4-3. Touch the [Back] key.

Setting up the audio language

- The factory default setting is "English".

- 4-1. Touch the [▶] key of the Audio Language item.
- 4-2. Touch the desired Language key you wish to set.
- 4-3. Touch the [Back] key.

Setting up the subtitle language

- The factory default setting is "English".

- 4-1. Touch the [▶] key of the Subtitle Language item.
- 4-2. Touch the desired Language key you wish to set.
 - To turn off the subtitle, select the [Off] key.
- 4-3. Touch the [Back] key.

Setting up the password for setting up of the parental level

- The factory default setting is "0000".

- 4-1. Touch the [▶] key of the Password item.
- 4-2. Touch the ten-key (0 to 9) to input a 4-digit password.
 - Input the old password, and touch the [ENT] key. Input "4356" to reset password.
 - Input a new password, and touch the [ENT] key.
 - Input the same new password again, and touch the [ENT] key.

Note:

- When a disc with view restrictions is inserted, you will be prompted to input a password. The disc will not be viewable until the correct password is entered.

Setting up the country code

Set up the country number for setting up of the parental level.

- The factory default setting is “8583” (U.S.A.).
- 4-1. Touch the [▶] key of the Country Code item.
 - 4-2. Touch the ten-key (0 to 9) to input a 4-digit country code (see the following table).
 - 4-3. Touch the [ENT] key.

Country code list:

Country	Input code
BRUNEI DARUSSALAM	6678
Kingdom of Cambodia	7572
INDONESIA	7368
KOREA, DEMOCRATIC PEOPLE'S REPUBLIC OF	7580
KOREA, REPUBLIC OF	7582
LAO PEOPLE'S DEMOCRATIC REPUBLIC	7665
MALAYSIA	7789
MYANMAR	7777
PHILIPPINES	8072
SINGAPORE	8371
THAILAND	8472
VIETNAM	8678
EAST TIMOR	8480
HONG KONG	7275
MACAU	7779
TAIWAN, PROVINCE OF CHINA	8487

Setting up the parental level

You can change the level of parental lock (audiovisual restriction).

This function allows cutting scenes that are unfavorable for children or replacing them automatically with other scenes prepared in advance. For example, by replacing scenes of radical violence or portrayals of sex with safe scenes, you can make a trouble-free story as if it were so from the beginning.

- The factory default setting is “8”.
- 4-1. Touch the [-] or [+] key of the Parental Level item.
The Password input screen is displayed.
 - 4-2. Touch the ten-key (0 to 9) to input a 4-digit password, and touch the [ENT] key.
 - The factory default setting of the password is “0000”.

- 4-3. Touch the [-] or [+] key to select level “1” to “8”, or “Off”.

The relationship between DVD video category codes and parental level are shown in the following table. Use this table when setting the parental level.

LEVEL7	NC-17 (NO ONE 17 AND UNDER ADMITTED)
LEVEL6	R (RESTRICTED)
LEVEL4	PG-13 (PARENTS STRONGLY CAUTIONED)
LEVEL3	PG (PARENTAL GUIDANCE SUGGESTED)
LEVEL1	G (GENERAL AUDIENCES)

- The contents that the parental level restricts vary with the country code.

□ Operating a DVD video

Watching a DVD Video

After disc loading, the play mode is automatically engaged.

- When playback is not started, touch the [▶/||] key.
- Operations may differ depending on the story of the disc.

● About the volume adjustment when playing DVD Video discs

This system has the independent volume data for playing DVD Video discs. The volume setting during DVD playback does not affect the volume of the other modes, and the volume setting in the other modes does not affect the DVD playback.

● When the DVD menu is displayed

For general DVD Video discs, the DVD menu may appear.

After the DVD menu is displayed, select an item in the operations described as follows.

Showing the DVD Video mode screen

The DVD Video mode screen is used to control the playback mode from the screen.

1. Touch the screen.

The DVD Video mode screen is displayed.

If you do not touch the screen for 7 seconds, the display will return to the playback screen.

Selecting the screen size

You can change the screen size to suit to the playback film.

- The factory default setting is "Full Wide".
1. Touch the screen to display the DVD Video mode screen.
 2. Repeat touching the [**S-Size**] key until your desired screen size is selected.
 - This key shows the current screen size setting.

[Full Wide]:

The image is expanded so that the rectangle of the image fits to the screen (16:9). The aspect ratio of the image may be changed.

[Cinema]:

The image is expanded so that the top and bottom edges of the image fit to the screen. Suitable for letterbox-format images. Subtitles of non-letterboxed images may be cut off in this mode.

[Normal]:

The image is expanded so that the top and bottom edges of the image fit to the screen, and that the aspect ratio of the image becomes 4:3. The aspect ratio of the image may be changed.

[Wide]:

The image is expanded so that the left and right edges of the image fit to the screen. The top and bottom areas of the image may be cut off.

3. Touch the [**Hide**] key to return to the playback screen.

DVD menu operations

●Showing the DVD menu

1. Showing the DVD Video mode screen, touch the [**Top Menu**] or [**Title Menu**] key during playback.

The DVD menu appears.

- The displayed contents for each key differ depending on the DVD software.
- An example shown below is the DVD menu display:



●Operating the DVD menu

You can operate the menu items by displaying the Key Pad panel.

1. Showing the DVD Video mode screen, touch the [**Cursor**] or [**10key**] key. The Cursor-Key Pad panel or the Numeric-Key Pad panel is displayed on the screen.
 - Touching the [**Num**] key or [**Cur**] key changes to the each other panel.
2. Select the desired menu item using either the Cursor-Key or the Numeric-Key according to the menu contents.
3. Touch the [**ENT**] key to specify the selected menu item.
4. Touch the [**Back**] key to hide the Key Pad panel.

● Switching Key Pad position

When the menu items become difficult to view by the Key Pad buttons, you can move the Key Pad panel to the other side of the screen.

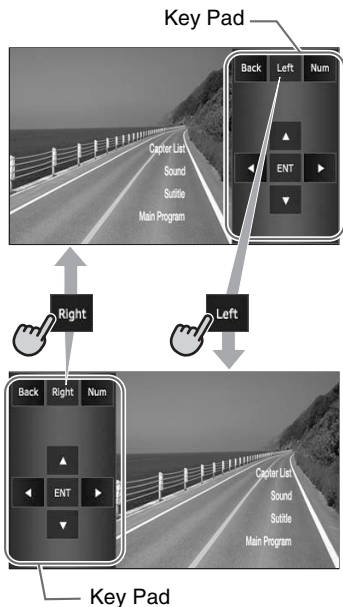

Stopping playback

1. Showing the DVD Video mode screen, touch and hold the [▶/||] key for more than 1 second during playback. Playback is stopped.
2. To resume playback, touch the [▶/||] key. Playback resumes from the scene where playback is stopped.

Pausing playback

1. Showing the DVD Video mode screen, touch the [▶/||] key during playback. Playback pauses.
2. To resume playback, touch the [▶/||] key again. Playback resumes.

Slow playback

1. Showing the DVD Video mode screen, touch the [▶/||] key during playback to pause playback.
2. Touch and hold the [▲ (Chapter)] key. While touching the key, slow playback continues at 1/3 speed. Releasing the key resumes the normal playback.
 - Slow playback cannot be performed in the backward direction. In addition, audio cannot be reproduced during slow playback.

Fast forward and fast backward

1. Showing the DVD Video mode screen, touch and hold the [▲ (Chapter)] or [▼ (Chapter)] key during playback.
 - [▲ (Chapter)] key: Fast forward
 - [▼ (Chapter)] key: Fast backward
 The playback speed becomes 4-time faster at first and then 16-time faster 3 seconds later. Releasing the key resumes the normal speed playback.
 - No audio is reproduced during fast forward and fast backward operation.
 - The fast forward and fast backward speed may differ depending on the disc.

Skipping chapters (searching)

“Chapter” means a small segment to divide the “Title” (film) which is recorded on the disc.

1. Showing the DVD Video mode screen, touch the [▲ (Chapter)] or [▼ (Chapter)] key during playback. Chapters are skipped as many as the times touching the key, and playback starts.

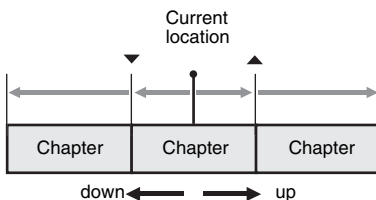

- Touching the [▲ (Chapter)] key starts playback from the beginning of the next chapter.
- Touching the [▼ (Chapter)] key starts playback from the beginning of the current chapter. When touching this key again within about 4 seconds, playback starts from the beginning of the previous chapter.

Searching with a chapter/title number

You can locate the beginning of a scene using the chapter numbers or title numbers recorded on the DVD video disc.

- “Chapter” means a small segment to divide the “Title” (film) which is recorded on the disc.
1. Showing the DVD Video mode screen, touch the **[Options]** key.
 2. Touch the **[Direct]** key.
The Key Pad screen appears.
 - You can specify the title number by touching the **[Title]** key.
 3. Input the chapter number that you want to play back using the **[0]** to **[9]** key.
 4. Touch the **[ENT]** key.
Playback starts from the scene of the input chapter number of the selected title.
 - If the input chapter number does not exist or searching with a chapter number is not allowed, the screen image will not change.

Repeat playback

This operation plays back the current title or chapter repeatedly.

1. Showing the DVD Video mode screen, touch the **[Options]** key.
2. Touch the **[Title]** or **[Chapter]** key of the Repeat item, then touch the **[Back]** key.
The “**T.RPT**” or “**C.RPT**” will be displayed.
3. Touch the **[Back]** key to return to the previous screen.
4. Perform the same operation to turn off the repeat playback.

Switching among languages

On discs in which two or more audios or audio languages have been recorded, you can switch among the audio languages during playback.

1. Showing the DVD Video mode screen, touch the **[Options]** key.
2. Touch the **[Audio]** key during playback.
Each time you touch the key, you can switch among audio languages.
 - Depending on the disc, up to 8 audios may be recorded. For details, see the mark of the disc (Ⓢ): Indicates that 8 audios have been recorded).
 - Depending on the disc, switching may be completely impossible or impossible on some scenes.
 - It may take time to switch among audios.
 - When the power is turned on and the disc is changed to a new one, the language set as the factory default is selected. If that language has not been recorded, the language is specified on the disc.
3. Touch the **[Back]** key to return to the previous screen.

Switching subtitles

On DVD discs in which two or more subtitle languages have been recorded, you can switch among the subtitle languages during playback.

1. Showing the DVD Video mode screen, touch the **[Options]** key.
2. Touch the **[Subtitle]** key during playback.
The Subtitle Language screen appears.
3. Touch the Language key you wish to display.
 - Depending on the disc, up to 32 kinds of subtitles may be recorded. For details, see the mark of the disc (Ⓢ): Indicates that 8 kinds of subtitles have been recorded).
 - To turn off subtitles, select “**OFF**”.
 - Depending on the disc, switching may be completely impossible or impossible on some scenes.
 - It may take time to switch among subtitles.
4. Touch the **[Back]** key to return to the previous screen.

Switching angles

On DVD discs in which video images have been recorded in two or more angles, you can switch among the angles during playback.

- When the Angle function is set to “On”, the angle mark will appear on scenes where the angles can be switched (see page 24).
1. Showing the DVD Video mode screen, touch the **[Angle]** key during playback.
Each time you touch the key, you can switch among angles.
 - Depending on the disc, up to 9 angles may be recorded. For details, see the mark of the disc (Ⓜ): Indicates multi-angle).
 - Depending on the disc, angles may switch smoothly or switch with a momentary still image.
 - Depending on the disc, switching may be completely impossible or impossible on some scenes.
 - It may take time to switch among angles.
 - Depending on the disc, scenes recorded in two or more angles may be played back.
 - When the power is turned on and the disc is changed to a new one, the language set at the time of factory shipment is selected. If that language has not been recorded, the language is specified on the disc.

Displaying/hiding the playback status

1. Showing the DVD Video mode screen, touch the **[Options]** key.
2. Touch the **[On]** or **[Off]** key of the P.Time item during playback.
3. Touch the **[Back]** key to return to the previous screen.
Playback status is displayed on the screen.

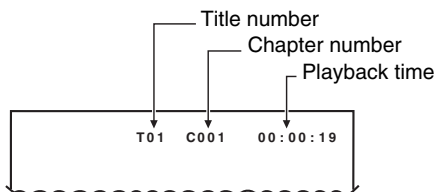

Video CD Operations

This system supports the Playback Control (PBC) function which is recorded on a Video CD for version 2.0 and used to control playback. Using pre-recorded menu screens in the Video CD with PBC, you can enjoy playback of software with a simplified dialog function.

❑ Selecting the Video CD mode

1. Set a Video CD disc to the DVD player.
The system will automatically read the disc data, change to the DVD mode (Video CD mode), and start playback after a while.
See also “Setting/Ejecting a Disc” (page 17).

⚠ WARNING

- **Some videos may be recorded at a higher volume level than desired. Increase the volume gradually from the minimal setting after the movie has started.**
- **For your safety, the driver should not watch the video or operate the controls while driving. Please note that watching and operating the movie while driving are prohibited by law in some countries.**

Note:

- *For your safety, this system has a safety function which turns off the picture when the car is moving, so only the audio can be heard. The picture can only be watched when the car is stopped and the parking brake is applied.*
- *“Audio Only” appears on the screen just after turning on the ACC power of the car, release the parking brake while confirming safety, and then engage the parking brake again.*

● When a disc is already set

1. Press the **[SRC]** button to display the Source screen.
2. Touch the **[DVD]** key to select the Video CD mode.
The system changes to the DVD mode (Video CD mode), and starts playback from the previous position.

❑ Operating a Video CD

Watching a Video CD

After disc loading, the play mode is automatically engaged.

- When playback is not started, touch the **[▶/||]** key.
- Operations may differ depending on the story of the disc.

● When the Video CD menu is displayed

For Video CD discs equipped with the PBC (Playback Control) function, the Video CD menu appears. After the Video CD menu is displayed, select an item in the following operations and play it back.

Note:

- There are two types of Video CDs, and these differ in some operations and functions. For the operations and functions of a Video CD, see the documents attached to the Video CD.

Operating the Video CD menu (for Video CD discs with PBC)

Note:

- This function is available only when the PBC function is set to ON (see page 30).
1. Touch the screen to display the Video CD mode screen, then touch the [10key] key during playback.
The Numeric-Key appears on the screen.
 2. Enter the number of desired menu item, and touch the [ENT] key to specify the menu item.

Note:

- The [Cursor] key cannot be used to select the menu items or tracks during playback.

Pausing playback

1. Showing the Video CD mode screen, touch the [▶/■] key during playback.
Playback pauses.
2. To resume playback, touch the [▶/■] key again.
Playback resumes.

Slow playback

1. Showing the Video CD mode screen, touch the [▶/■] key during playback to pause playback.
Playback pauses.
2. Touch and hold the [▲ (Track)] key.
While touching the key, slow playback continues at 1/3 speed.
 - Slow playback cannot be performed in the backward direction. In addition, audio cannot be reproduced during slow playback.

Skipping a track (searching)

1. Touch the [▲ (Track)] or [▼ (Track)] key during playback.
The track is skipped and playback starts.
 - Touching the [▲ (Track)] key starts playback from the beginning of the next track.
 - Touching the [▼ (Track)] key starts playback from the beginning of the current track.
When this button is pressed again within about 2 seconds, playback starts from the beginning of the previous track.

Fast forward and fast backward

1. Touch and hold the [▲ (Track)] or [▼ (Track)] key during playback.
The playback speed becomes 4-time faster at first and then 16-time faster 3 seconds later.
Releasing the button resumes the normal speed playback.
 - No audio is reproduced during fast forward and fast backward operation.

Changing audio output channels

You can change the audio output channels.

1. Showing the Video CD mode screen, touch the [Options] key.
2. Touch the [LR], [LL], or [RR] key of the Audio item to select the output channel.
LR: Left and Right channels
LL: Left channel only
RR: Right channel only
3. Touch the [Back] key to return to the previous screen.

Setting the Playback Control function

On Video CDs equipped with Playback Control function, you can turn it on/off.

- The factory default setting is "Off".
1. Showing the Video CD mode screen, touch the [Options] key.
 2. Touch the [On] or [Off] key of the PBC item to set the function ON or OFF.
 3. Touch the [Back] key to return to the previous screen.

Note:

- When the PBC setting is changed, the disc plays from the beginning.

Displaying/hiding the playback status

- The factory default setting is "Off".
- Showing the Video CD mode screen, touch the **[Options]** key.
 - Touch the **[On]** or **[Off]** key of the P. Time item to set the function ON or OFF.
 - Touch the **[Back]** key to return to the previous screen.

Note:

- This function is disabled when the PBC function is set to ON.

Selecting the screen size

You can change the screen size to suit to the playback film.

- The factory default setting is "Full Wide".
- Touch the screen to display the Video CD mode screen.
 - This key shows the current screen size setting.
 - Repeat touching the **[Full Wide/Cinema/Normal/Wide]** key until your desired screen size is selected.

[Full Wide]:

The image is expanded so that the rectangle of the image fits to the screen (16:9). The aspect ratio of the image may be changed.

[Cinema]:

The image is expanded so that the top and bottom edges of the image fit to the screen. Suitable for letterbox-format images. Subtitles of non-letterboxed images may be cut off in this mode.

[Normal]:

The image is expanded so that the top and bottom edges of the image fit to the screen, and that the aspect ratio of the image becomes 4:3. The aspect ratio of the image may be changed.

[Wide]:

The image is expanded in the same way as the **[Full Wide]** setting, but the width will become narrower. Depending on the image data, black areas may be displayed at the both sides of the screen.

- Touch the **[Hide]** key to return to the playback screen.

Audio CD Operations

This system is a CD TEXT compatible model, and supports the display of the DISC TITLE, TRACK TITLE, and TRACK ARTIST (or DISK ARTIST) of the CD TEXT.

Note:

- This unit supports only CD TEXT in English. Also, some character data may not be reproduced properly on the display.

Selecting the CDDA mode

- Set an audio CD to the DVD player. The system will automatically read the disc data, change to the DVD mode (CDDA mode), and start playback after a while. See also "Setting/Ejecting a Disc" (page 17).



⚠ WARNING

- Some CDs may be recorded at a higher volume level than desired. Increase the volume gradually from the minimal setting after playback has started.
- For your safety, the driver should not operate the controls while driving.

● When an audio CD is already set

- Press the **[SRC]** button to display the Source screen.
- Touch the **[DVD]** key to select the CDDA mode. The system changes to the DVD mode (CDDA mode), and starts playback from the previous position.

Operating an audio CD

Listening to an audio CD

After disc loading, the play mode is automatically engaged.

- When playback is not started, touch the **[▶/||]** key.

Pausing playback

1. Touch the **[▶/■]** key during playback. Playback pauses.
2. To resume playback, touch the **[▶/■]** key. Playback resumes.

Skipping a track (searching)

1. Touch the **[▲ (Track)]** or **[▼ (Track)]** key during playback. Tracks are skipped, as many as the times the key is touched, and playback starts.
 - Touching the **[▲ (Track)]** key starts playback from the beginning of the next track.
 - Touching the **[▼ (Track)]** key starts playback from the beginning of the current track. When this key is touched again within about 2 seconds, playback starts from the beginning of the previous track.

Fast forward and fast backward

1. Touch and hold the **[▲ (Track)]** or **[▼ (Track)]** key during playback. The playback speed becomes 4-time faster first and then 16-time faster 3 seconds later. Releasing the key resumes the normal speed playback.

Other various play functions

1. Touch the **[Options]** key.
2. Touch the **[Track]** key of the function you want to play.

Track repeat playback:

Touch the **[Track]** key of the Repeat item.

 - This operation plays back the current track repeatedly.
 - **"T.RPT"** is displayed on the screen.
 - You can also specify this function by touching the **[Repeat]** key on the CDDA mode screen.

Track random playback:

Touch the **[Track]** key of the Random item.

 - This operation plays back all tracks on the disc in no particular order.
 - **"T.RDM"** is displayed on the screen.
 - You can also specify this function by touching the **[Random]** key on the CDDA mode screen.
3. To cancel the play, touch the **[Track]** key of the function to cancel.
4. Touch the **[Back]** key to return to the previous screen.

Scrolling track titles

When a title or name displayed on the screen is longer than the text area, you can confirm the entire text by scrolling it.

1. Displaying the text you wish to scroll, touch the text area. The text will scroll once.

MP3/WMA/AAC Operations

This system can playback MP3/WMA/AAC files recorded on a disc.

□ About the MP3/WMA/AAC files

What is MP3/WMA/AAC?

MP3, WMA, and AAC are the audio file formats which have penetrated into PC users and become a standard format.

MP3 is an audio compression method and classified into audio layer 3 of MPEG standards. WMA (Windows Media Audio) is an audio compression method developed by Microsoft Corporation.

AAC (Advanced Audio Coding) is a newer audio compression method developed for used with video compression standards MPEG-2 and MPEG-4, and has been adopted as the standard audio format of the iPod and iTunes by Apple Inc. These features compress the original audio data to about 10 percent of its initial size with a high sound quality. This means that about 10 audio CDs can be recorded on a CD-R/RW disc to allow a long listening time without having to change CDs.

Displaying MP3/WMA/AAC Tag titles

Tag information (track title, artist name, and album title) can be displayed for an MP3/WMA/AAC file containing the Tag information.

This system supports the ID3 TAG version 1.x/2.x and WMA-TAG.

Note:

- Tag information entered with 2-byte characters may not be displayed properly on the display.
- The ID3 version 2.x tag format is not completely supported. This system can display information up to 60 bytes, and ignores the rest.
- Album titles of WMA-TAG may not be displayed properly.

Precautions on the MP3/WMA/AAC files

General precautions

- Files other than MP3/WMA/AAC format cannot be played. In addition, some files may not be played because of the encoding settings. When a file cannot be played, the next file is played instead.
- Some noise may occur depending on the type of encoder software used to encode the data.
- You can apply the VBR (Variable Bit Rate) format when encoding. In this case, the displayed play time may be slightly different from the actual play time.
- Files that the DRM (Digital Rights Management) function is set cannot be played.

For MP3 files

- Set the Sampling Frequency to:
 - MPEG1 Layer3: 32, 44.1, or 48 kHz
 - MPEG2 Layer3: 16, 22.05, or 24 kHz
 - MPEG2.5 Layer3: 8, 11.025, or 12 kHz
- Set the Bit Rate to:
 - MPEG1 Layer3: 32 to 320 kbps (VBR)
 - MPEG2 Layer3: 8 to 160 kbps (VBR)
 - MPEG2.5 Layer3: 8 to 160 kbps (VBR)
- Add a file extension “.MP3” or “.mp3” using single byte characters.

For WMA files

- Set the Sampling Frequency to within ranges from 22.05 to 44.1 kHz.
- Set the Bit Rate to 48, 64, 80, 96, 128, 160, or 192 kbps.
- Add a file extension “.WMA” or “.wma” using single byte characters.

For AAC files

- This system supports only the MPEG4 Audio files encoded by the iTunes.
- Set the Sampling Frequency to 44.1 or 48 kHz.
- Set the Bit Rate to within ranges from 16 to 320 kbps (VBR).
- Add a file extension “.M4A” or “.m4a” using single byte characters.

Precautions when preparing a disc

Note:

- For details of the DivX file mentioned below, see “DivX Operations” (page 35).

Logical format (File system)

The following writing formats are available when writing MP3/WMA/AAC/DivX files on a disc:

- For CD-R/RW: ISO9660 level 1/level 2, Romeo, Joliet, or Apple ISO (without including expansion format)
- For DVD±R/RW: UDF (Universal Disk Format)

Folder structure

- The folder hierarchy must be within 8 hierarchical levels. Otherwise, playback will be impossible.
- You can store the MP3 files, WMA files, and AAC files together in a disc or folder.
- You can also store the MP3/WMA/AAC files and DivX files together in a disc or folder. In such a case, you can select whether the disc is regarded as an MP3/WMA/AAC disc or as a DivX disc. See “Setting the Playform of discs recorded with DivX files” (page 35).

Number of files or folders

- The maximum allowable number of folders is 255 (including root directory).
- The maximum allowable number of files in a folder is 255.

Folder representation in the folder list

- Only folders containing MP3/WMA/AAC files or DivX files (① to ④ in illustration) are displayed on the list. Folders containing no MP3/WMA/AAC/DivX file are not displayed.
- Folder hierarchy (① to ④ in illustration) is ignored, and unified into one level.
- Folders are arranged in the order of the folder creation.

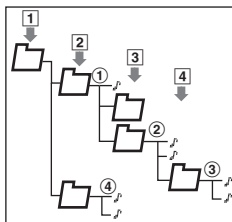

❑ Selecting the MP3/WMA/AAC mode

1. Set a disc which the MP3/WMA/AAC files are recorded to the DVD player.

The system will automatically read the disc data, change to the DVD mode (MP3/WMA/AAC mode), and start playback after a while. See also "Setting/Ejecting a Disc" (page 17).



⚠ WARNING

- Audio files may be recorded at a higher volume level than desired. Increase the volume gradually from the minimal setting after playback has started.
- For your safety, the driver should not operate the controls while driving.

Note:

- Note that the system enters to the DivX mode when setting a disc with DivX files if the Playform function has been set to "Video" (see page 35).

● When a disc is already set

1. Press the [SRC] button to display the Source screen.
2. Touch the [DVD] key to select the MP3/WMA/AAC mode.
The system changes to the DVD mode (MP3/WMA/AAC mode), and starts playback from the previous position.

❑ Operating MP3/WMA/AAC playback

Note:

- The same operations listed below are also used in the USB Memory mode.

Listening to MP3/WMA/AAC files

After disc loading, the play mode is automatically engaged.

- When playback is not started, touch the [▶/■] key.

Pausing playback

1. Touch the [▶/■] key during playback.
Playback pauses.
2. To resume playback, touch the [▶/■] key.
Playback resumes.

Skipping a track (searching)

1. Touch the [▲ (Track)] or [▼ (Track)] key during playback.
Tracks are skipped, as many as the times the key is touched, and playback starts.
 - Touching the [▲ (Track)] key starts playback from the beginning of the next track.
 - Touching the [▼ (Track)] key starts playback from the beginning of the current track.
When this key is touched again within about 2 seconds, playback starts from the beginning of the previous track.
- These functions perform in the current folder only.

Fast forward and fast backward

1. Touch and hold the [▲ (Track)] or [▼ (Track)] key during playback.
The playback speed becomes 4-time faster first and then 16-time faster 3 seconds later. Releasing the key resumes the normal speed playback.

Skipping the current folder

1. Touch the [▲ (Folder)] or [▼ (Folder)] key during playback.
The tracks of the current folder are skipped and playback starts from the first track of the next or previous folder.

Selecting a folder/track from the list screen

1. Touch the [List] key.
The Folder List screen is displayed.
2. When the desired folder is not displayed, touch the [▲] or [▼] key to scroll the list.
3. Touch the desired Folder key.
The Track List screen appears.
4. Touch the [▲] or [▼] key to scroll the list, and touch the desired Track key.
The corresponding track is started playback.
5. Touch the [Back] key.

Other various play functions

1. Touch the **[Options]** key.
2. Touch a touch key of the function you want to play.

Folder repeat playback:

Touch the **[Folder]** key of the Repeat item.

- This operation plays back tracks in the current folder repeatedly.
- "F.RPT" is displayed on the screen.

Track repeat playback:

Touch the **[Track]** key of the Repeat item.

- This operation plays back the current track repeatedly.
- "T.RPT" is displayed on the screen.

Folder random playback:

Touch the **[Folder]** key of the Random item.

- This operation plays the tracks in the current folder in a random order.
- "F.RDM" is displayed on the screen.

Track random playback:

Touch the **[Track]** key of the Random item.

- This operation plays back tracks recorded in the disc in no particular order.
 - "T.RDM" is displayed on the screen.
3. To cancel the play, touch the same touch key of the function to cancel.
 4. Touch the **[Back]** key to return to the previous screen.

Scrolling track titles

When a title or name displayed on the screen is longer than the text area, you can confirm the entire text by scrolling it.

1. Displaying the text you wish to scroll, touch the text area.
The text will scroll once.

Setting the Playform of discs recorded with DivX files

MP3/WMA/AAC files can be stored together with DivX files in a disc or folder. You can select whether such discs are regarded as MP3/WMA/AAC discs or as DivX discs.

1. Touch the **[Options]** key.
2. Touch the **[Audio]** or **[Video]** key of the Playform item to specify the setting.
 - [Audio]:**
Discs are regarded as MP3/WMA/AAC discs.
 - [Video]:**
Discs are regarded as DivX discs.
3. Touch the **[Back]** key if required.

Note:

- This setting is disabled when a Mixed Mode CD, which contains both data track and audio tracks, is set in the DVD player.

DivX Operations

This system can playback DivX movie files recorded on a disc.

- Official DivX[®] Certified product
- Plays all versions of DivX[®] video (including DivX[®] 6) with standard playback of DivX[®] media files.

□ About the DivX file

What is DivX?

DivX is a popular media technology created by DivX, Inc. DivX media files contain highly compressed video with high visual quality that maintains a relatively small file size. DivX files can also include advanced media features like menus, subtitles, and alternate audio tracks. Many DivX media files are available for download online, and you can create your own using your personal content and easy-to-use tools from DivX.com.

Precautions on the DivX file

- This system can play DivX version 4.x, 5.x, and 6.x files. DivX Ultra is not supported.
- Files other than DivX format (such as the Xvid files) cannot be played. In addition, some files may not be played because of the encoding format. When a file cannot be played, the next file is played instead.

- DivX VOD (Video-on Demand files) that have authorization data can also be played. These files must be authorized on your PC beforehand using the DivX Registration Code displayed on the System tab screen under the General screen (see page 48).
- Set the Frame Size to 640 × 480 or 320 × 240 pixels.
- Set the Frame Rate to 30 or 15 fps.
- Add a file extension “.AVI”, “.avi”, “.DIVX”, or “.divx” using single byte characters.

Precautions when preparing a disc

Note:

- The limitations on preparing a disc are same as those in the MP3/WMA/AAC modes. See “Precautions when preparing a disc” (page 33).

□ Selecting the DivX mode

1. Set a disc which the DivX files are recorded to the DVD player.

The system will automatically read the disc data, change to the DVD mode (DivX mode), and start playback after a while.

See also “Setting/Ejecting a Disc” (page 17).

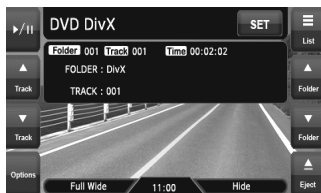

⚠ WARNING

- **Some movie files may be recorded at a higher volume level than desired. Increase the volume gradually from the minimal setting after the movie has started.**
- **For your safety, the driver should not watch the movie or operate the controls while driving. Please note that watching and operating the movie while driving are prohibited by law in some countries.**

Note:

- For your safety, this system has a safety function which turns off the picture when the car is moving, so only the audio can be heard. The picture can only be watched when the car is stopped and the parking brake is applied.
- If “**Audio Only**” appears on the screen just after turning on the ACC power of the car, release the parking brake while confirming safety, and then engage the parking brake again.
- You can store DivX files and the MP3/WMA/AAC files together in a disc or folder. In such a case, you can select whether the disc is regarded as a DivX disc or as an MP3/WMA/AAC disc. See “Setting the Playform of discs recorded with audio files” (page 38).

● When a disc is already set

1. Press the [SRC] button to display the Source screen.
2. Touch the [DVD] key to select the DivX mode. The system changes to the DVD mode (DivX mode), and starts playback from the previous position.

□ Operating DivX playback

Note:

- The most operations in the DivX mode are same as those in the MP3/WMA/AAC modes. See also “Operating MP3/WMA/AAC playback” (page 34).
- The random plays cannot be specified in the DivX mode.

Watching DivX movies

After disc loading, the play mode is automatically engaged.

- When playback is not started, touch the [▶/||] key.

● To play a file with Authorization data

When a file with Authorization data is played, a message is displayed on the screen. Confirm the message displayed, and touch the [Done] or [Yes] key to play the movie.

Showing the DivX mode screen

The DivX mode screen is used to control the playback mode from the screen.

1. Touch the screen.
The DivX mode screen is displayed.
If you do not touch the screen for 7 seconds, the display will return to the playback screen.
 - You can hide the DivX mode screen by touching the **[Hide]** key.

Selecting the screen size

You can change the screen size to suit to the playback film.

- The factory default setting is "Full Wide".
1. Touch the screen to display the DivX mode screen.
 2. Repeat touching the **[Full Wide/Cinema/Normal/Wide]** key until your desired screen size is selected.
 - This key shows the current screen size setting.

[Full Wide]:

The image is expanded so that the rectangle of the image fits to the screen (16:9). The aspect ratio of the image may be changed.

[Cinema]:

The image is expanded so that the top and bottom edges of the image fit to the screen. Suitable for letterbox-format images. Subtitles of non-letterboxed images may be cut off in this mode.

[Normal]:

The image is expanded so that the top and bottom edges of the image fit to the screen, and that the aspect ratio of the image becomes 4:3. The aspect ratio of the image may be changed.

[Wide]:

The image is expanded so that the left and right edges of the image fit to the screen. The top and bottom areas of the image may be cut off.

3. Touch the **[Hide]** key to return to the playback screen.

Searching with a folder/track number

You can specify a file to play using the folder number or track number.

1. Showing the DivX mode screen, touch the **[Options]** key.
2. Touch the **[Direct]** key.
The Key Pad screen appears with the folder number input mode.
3. Input the folder/track number that you want to play back using the **[0]** to **[9]** key.
 - Touching the **[Track]** key turns the Key Pad to the track number input mode.
4. Touch the **[ENT]** key.
The system starts playback of the file specified with the input folder/track numbers.
 - If the input folder/track number does not exist or searching with a folder/track number is not allowed, the screen image will not change.

Switching Audios

You can switch the audio data if the current DivX file has two or more audio data.

1. Showing the DivX mode screen, touch the **[Options]** key.
2. Touch the **[Audio]** key during playback or pause.
Each time you touch the key, you can switch among the audio data.
 - The number of audios recorded and their audio formats may differ depending on the DivX file.
 - Depending on the DivX file, switching may be impossible.
 - It may take time to switch the audio data.
3. Touch the **[Back]** key.

Switching Subtitles

You can switch the subtitle language if the current DivX file has one or more subtitles.

1. Showing the DivX mode screen, touch the **[Options]** key.
2. Touch the **[Subtitle]** key during playback or pause.
Each time you touch the key, you can switch among the subtitle language.
 - The number of subtitles recorded may differ depending on the DivX file.
 - Depending on the DivX file, switching may be impossible.
 - It may take time to switch the subtitle language.
3. Touch the **[Back]** key.

Setting the Playform of discs recorded with audio files

DivX files can be stored together with MP3/WMA/AAC files in a disc or folder. You can select whether such discs are regarded as DivX discs or as MP3/WMA/AAC discs.

1. Showing the DivX mode screen, touch the **[Options]** key.
2. Touch the **[Audio]** or **[Video]** key of the Playform item to specify the setting.

[Audio]:
Discs are regarded as MP3/WMA/AAC discs.

[Video]:
Discs are regarded as DivX discs.
3. Touch the **[Back]** key if required.

Note:

- This setting is disabled when a Mixed Mode CD, which contains both data track and audio tracks, is set in the DVD player.

6. SOURCE OPERATIONS (ACCESSORIES)

iPod Operations

iPods can be connected by using the connector cable supplied with the iPod, but in this case, you can enjoy its audio sound only. To enjoy video movies stored in the iPod with video displaying them on this unit, it is required to use the special connector cable (CCA-723) separately sold.

Note:

- This system will not operate or may operate improperly with unsupported versions.
- For detailed information on the playable iPod models, see our home page: www.clarion.com

□ Notes on using Apple iPod

- Do not connect an iPod to this unit with a headphone connected to the iPod.
- When in the iPod mode, the screen image input from the AUX1 terminal is output to the rear monitor.
- When no data is present, the title display will remain blank.
- The iPod is used with the equalizer function turned OFF.
- Set the iPod's language setting to English before connecting your iPod. Some characters of the other languages may not be displayed correctly in this system.

● Precautions on battery consumption:

If the iPod is connected to this unit when the iPod's internal battery has run down, this function may not operate correctly. You must connect the iPod after charging the battery if it has run down.

□ Selecting the iPod mode

1. Connect your iPod to the USB connector.
The system will automatically detect the connected device, and change to the USB mode (iPod mode), and start playback after a while.
See also "Connecting/Disconnecting an USB Media Device" (page 18).

● When an iPod is already connected

1. Press the **[SRC]** button to display the Source screen.
2. Touch the **[USB]** key to select the iPod mode.
The system changes to the USB mode (iPod mode), and starts playback from the previous position.

□ Controlling the iPod

Operation keys

● iPod mode screen



[Music/Videos] key:

Switches the operation mode to the Video mode or Music mode.

- Enabled in the Simple Control mode.

List keys:

Displays the corresponding list screen to select track to be played.

[Videos], [Playlists], and [Music] are available.

[Hide] key:

Hides the iPod mode screen to display the playback picture.

- Displayed only in the Video mode.

[Options] key:

Displays the Options screen. You can specify play modes and other settings from this screen.

Play mode icons:

Displays status of Repeat, Shuffle play.

- : 1-track Repeat
- : All Repeat
- : Song Shuffle
- : Album Shuffle

Pausing playback

1. Touch the key during playback.
Playback pauses.
2. To resume playback, touch the key again.
Playback resumes.

Skipping a track (searching)

1. Touch the [(Track)] or [(Track)] key during playback.
Tracks are skipped, as many as the times the key is touched, and playback starts.
 - Touching the [(Track)] key starts playback from the beginning of the next track.
 - Touching the [(Track)] key starts playback from the beginning of the current track. When this key is kept touching, playback starts from the beginning of the previous track.

Fast forward and fast backward

1. Touch and hold the [(Track)] or [(Track)] key during playback.
The playback speed becomes faster.
Releasing the key resumes the normal speed playback.

Scrolling track titles

When a title or name displayed on the screen is longer than the text area, you can confirm the entire text by scrolling it.

1. Displaying the text you wish to scroll, touch the text area.
The text will scroll once.

Controlling from the iPod

Setting this function to "On" enables to use the iPod buttons to control the iPod.

1. Touch the [Options] key.
2. Touch the [On] or [Off] key of the Simple Control item to specify the setting.
 - [On]:**
Enables the iPod buttons. Only the above operations can be performed from this system.
 - [Off]:**
Disables the iPod buttons. All controls are performed from this system.
3. Touch the [Back] key to return to the previous screen.

Other various play functions

1. Touch the **[Options]** key.
2. Touch a touch key of the function you want to play.

1-track repeat:

- Touch the **[One]** key of the Repeat item.
- This operation plays back the current or selected track repeatedly.

All repeat:

- Touch the **[All]** key of the Repeat item.
- This operation plays back all the tracks currently selected repeatedly.

Song shuffle:

- Touch the **[Song]** key of the Shuffle item.
- This operation plays back all the tracks currently selected in a random order.

Album shuffle:

- Touch the **[Album]** key of the Shuffle item.
- When more than one album is selected, this operation plays back the albums in no particular order. Tracks in an album are played back in the recorded order.
3. To cancel the shuffle play, touch the **[Off]** key of the function to cancel.
 - The repeat play cannot be canceled. Normally, it should be set to the All repeat play.
 4. Touch the **[Back]** key to return to the previous screen.

Note:

- *"All repeat" will be selected automatically when you connect the iPod which is turned off the repeat function.*

□ Selecting tracks to be played

You can specify the tracks to be played by touching the following list keys:

● [Videos] key

The following category keys are displayed. You can narrow the listed items by selecting these categories.

- The category keys displayed may differ depending on the connected iPod.

[Playlists]:

The list of all the Video Playlists stored in the iPod is displayed.

[Movies]:

The list of all the Movies stored in the iPod is displayed.

[Music Videos]:

You can narrow the Albums to be listed by specifying the Artist name.

[Rental]:

The list of all the Rental Movies stored in the iPod, which are downloaded with iTunes Movie Rentals, is displayed.

[TV Shows]:

You can narrow the Seasons to be listed by specifying the Program title.

[Video Podcasts]:

You can narrow the Tracks to be listed by specifying the Video Podcast name.

● [Playlists] key

The list of all the Playlists and Video Playlists stored in the iPod is displayed.

● [Music] key

The following category keys are displayed. You can narrow the listed items by selecting these categories.

- The category keys displayed may differ depending on the connected iPod.

[Playlists]:

The list of all the Playlists stored in the iPod is displayed.

[Artists]:

You can narrow the Albums to be listed by specifying the Artist name.

[Albums]:

The list of all the Albums stored in the iPod is displayed.

[Songs]:

The list of all the Tracks stored in the iPod is displayed.

[Genres]:

You can narrow the Artists to be listed by specifying the Genre name.

[Composers]:

You can narrow the Albums to be listed by specifying the Composer name.

Selecting tracks to be played from a list screen

1. Touch the desired Category key from the iPod mode screen to display the corresponding list screen.
2. Touch the desired item key on the screen to specify it.
 - Touch the [▲] or [▼] key to scroll the list. You can also use the ABC Search function to scroll the list (see below).
 - When a track list of an Album, Playlist, or Video Playlist is displayed, specifying a track starts playback of the specified album/playlist from the specified track.
 - When the track list of the Songs is displayed, specifying a track starts playback of all the tracks stored in the iPod from the specified track.
 - When the other list screen is displayed, repeat this operation until you select the tracks to be played back.
 - When video tracks are specified in the Music mode, only the audio data will be played back.
3. Touch the [Back] key to return to the previous screen.

● Using the ABC Search function

1. Touch the [ABC Search] key when the list screen you wish to scroll is displayed.
2. Repeat touching the [A ▶], [◀ Z], or [0-9] key to specify the initial character of the list item you wish to display.
3. Touch the [Search] key.
The list will scroll to display the first item started from the specified character (or a following character).

□ Viewing video data in the iPod (only for the iPod with video)

When you connect an iPod with video by using the optional connector cable, you can enjoy the video data stored in the iPod showing them on the operation panel of this unit (and the rear monitor if connected).

⚠ WARNING

- **Some videos may be recorded at a higher volume level than desired. Increase the volume gradually from the minimal setting after the video has started.**
- **For your safety, the driver should not watch the video or operate the controls while driving. Please note that watching and operating the video while driving are prohibited by law in some countries.**

1. Play back your desired video tracks.
The system will automatically enter into the Video mode and the playback starts. The specified video image is also displayed on the rear monitor if connected.
 - When in the Simple Control mode, touch the [Music/Videos] key to switch to the Video mode. To return to the Music mode, touch the [Music/Videos] key again.
2. Touch the [Hide] key to hide the iPod mode screen.
The video image will be displayed on this unit.
3. To display the iPod mode screen, touch the screen.

Note:

- **"Audio Only"** is displayed when the automobile is moving.
- Video data may not be played back according to the status of the iPod.
- The volume setting of video data is relatively lower than audio data. Be sure to lower the volume setting before switching to the other mode.
- Do not select the categories with no track registered from a list screen. The iPod may be frozen. If the iPod is frozen, reset the iPod by following the procedure described in the instruction manual of the iPod.

Selecting the Output Signal

This setting is used to select the audio signal of video tracks.

1. Touch the **[Options]** key.
2. Touch the **[Digital]** or **[Analog]** key of the Output Signal item to specify the setting.
 - [Digital]:**
The digital audio data via the USB will be output. Normally select this setting.
 - [Analog]:**
The analog audio data via the AUX1 will be output. Select this setting if your iPod cannot output digital signals.
3. Touch the **[Back]** key to return to the previous screen.

Note:

- Make sure to reconnect the iPod after changing this setting. The key (**[Digital]** or **[Analog]**) indicator and output setting will be changed after reconnecting your iPod.

USB Memory Operations

This system can play audio files (MP3/WMA/AAC) stored in a USB memory which is recognized as "USB Mass Storage Class device". You can use your USB memory as an audio device by simply copying desired audio files into it.

Note:

- This system will not operate or may operate improperly with some USB memory.
- Files protected with any DRM can not be played.

Notes on using USB memories

General notes

- When no data is present, the message "No File" will be displayed.
- The USB memory is used with the equalizer function turned OFF.

Notes on the MP3/WMA/AAC files

- This system can play the MP3/WMA/AAC files stored in the USB memory.
- This system cannot play DivX files stored in the USB memory.
- For AAC files, this system supports only the MPEG4 Audio files encoded by the iTunes.
- Set the Sampling Frequency to:
 - For MP3 files:
 - MPEG1 Layer3: 32, 44.1, or 48 kHz
 - MPEG2 Layer3: 16, 22.05, or 24 kHz
 - MPEG2.5 Layer3: 8, 11.025, or 12 kHz
 - For WMA files: 32, 44.1, or 48 kHz
 - For AAC files: 44.1 or 48 kHz

- Set the Bit Rate to:
 - For MP3 files:
 - MPEG1 Layer3: 32 to 320 kbps (VBR)
 - MPEG2 Layer3: 16 to 160 kbps (VBR)
 - MPEG2.5 Layer3: 16 to 160 kbps (VBR)
 - For WMA files: 32, 48, 64, 80, 96, 128, 160, or 192 kbps
 - For AAC files: 16 to 320 kbps (VBR)
- Add the following file extension using single byte characters:
 - For MP3 files: ".MP3" or ".mp3"
 - For WMA files: ".WMA" or ".wma"
 - For AAC files: ".M4A" or ".m4a"

Notes on the folder structure

- The folder hierarchy must be within 8 hierarchical levels. Otherwise, playback will be impossible.
- The maximum allowable number of folders is 512 (including root directory and folders with no MP3/WMA/AAC file).
- The maximum allowable number of files in a folder is 255.
- You can store the MP3 files, WMA files, and AAC files together in a folder.

Notes on the Tag titles

The limitations on the Tag titles are same as those in the MP3/WMA/AAC modes. See "Displaying MP3/WMA/AAC Tag titles" (page 33).

Folder representation in the folder list

The limitations on the folder representation are same as those in the MP3/WMA/AAC modes. See "Folder representation in the folder list" (page 33).

Selecting the USB Memory mode

1. Connect your USB memory to the USB connector.
The system will automatically detect the connected device, and change to the USB mode (USB Memory mode), and start playback after a while.
See also "Connecting/Disconnecting an USB Media Device" (page 18).



● When an USB memory is already connected

1. Press the [SRC] button to display the Source screen.
2. Touch the [USB] key to select the USB Memory mode.
The system changes to the USB mode (USB Memory mode), and starts playback from the previous position.

□ **Playing back files in the USB memory**

The operations in the USB Memory mode are same as those in the MP3/WMA/AAC modes. See "Operating MP3/WMA/AAC playback" (page 34) for details.

Note:

- When performing the fast forward or fast backward function, the playback speed will become 10-time faster. For the VBR files, it may differ depending on the file.

Navigation System Operations

Notes on the Navi functions

- Hereafter in this section, the Navigation system will be called as "Navi".
- The following functions are available:
 - Showing the Navi display (The [Navi] key selection available on the Source screen)
 - Showing the current location screen (The [Map] key selection available on the Source screen).
 - Navi guidance voice interruption
- When a voice interrupt of the Navi arises during 2-Zone ON, the sound of the Main zone is muted, and the sound of the Sub zone is output normally. When it arises during 2-Zone OFF, the audio signals to the 4ch speakers are attenuated, and the voice from the navigation system is output from the front two speakers.

Note:

- The [Map] key may be disabled depending on the navigation system conditions.

Navi operations

Changes between the Navi display and the Audio/Visual (hereinafter, referred as "AV") display.

● When in the AV mode

- Touch the [Navi] or [Map] key on the Source screen to switch to the Navi mode.
- When the image interruption from the Navi arises, the screen will be changed to the Navi display. When the interruption is finished, the screen will return to the previous AV display.

Note:

- Depending on the distance to the next guidance point and the vehicle's speed, the image interruption may continue until the next route guidance finishes.

● When in the Navi mode

- Touch the [AV] key on the Source screen to switch to the AV mode.

Note:

- For more information on the Navi mode, see the User Manual.

AUX Operations

This function is available when a VTR, etc. is connected to the AUX1 or AUX2 terminal.

⚠ WARNING

- For your safety, the driver should not watch the video or operate the controls while driving. Please note that watching and operating the video while driving are prohibited by law in some countries.

Note:

- For your safety, this system has a safety function which turns off the picture when the car is moving, so only the audio can be heard. The picture can only be watched when the car is stopped and the parking brake is applied.
- When an iPod with video is connected to the AUX1 terminal using the special connector cable (CCA-723) separately sold, the video/audio input from the iPod will be output to the monitor screen and rear monitor even in the AUX1 mode. However, you must select the iPod mode to control the iPod.

Selecting the AUX mode

1. Press the [SRC] button, and touch the [AUX] key. The system will enter into the AUX mode.

Showing the AUX mode screen

The AUX mode screen is used to adjust settings concerning the AUX mode.

1. Touch the screen.
The AUX mode screen is displayed.
If you do not touch the screen for 7 seconds, the display will return to the video screen.

Switching to another AUX mode

1. Showing the AUX mode screen, touch the **[AUX]** key.
The system will enter into another AUX mode.

Changing the audio input level

The input audio level of the AUX terminals can be changed.

- The factory default setting is “**High**”.
1. Touch the screen to display the AUX mode screen, then repeat touching the **[Sense]** key to select the level.
High: 10 dB
Mid: 4 dB
Low: 0 dB

Selecting the screen size

You can change the screen size to suit to the video image.

- The factory default setting is “**Full Wide**”.
1. Touch the screen to display the AUX mode screen.
 2. Repeat touching the **[S-Size]** key until your desired screen size is selected.
 - This key shows the current screen size setting.

[Full Wide]:

The image is expanded so that the rectangle of the image fits to the screen (16:9). The aspect ratio of the image may be changed.

[Cinema]:

The image is expanded so that the top and bottom edges of the image fit to the screen.

[Normal]:

The image is expanded so that the top and bottom edges of the image fit to the screen, and that the aspect ratio of the image becomes 4:3. The aspect ratio of the image may be changed.

[Wide]:

The image is expanded so that the left and right edges of the image fit to the screen. The top and bottom areas of the image may be cut off.

3. Touch the **[Hide]** key to return to the video screen.

7. SYSTEM SETTINGS

Audio Settings

□ Displaying the Audio screen

You can customize the various audio settings of this unit from the Audio screen.

1. Touch the **[SET]** key.
The Settings screen appears.
2. Touch the **[Audio]** key.
The Audio screen appears.

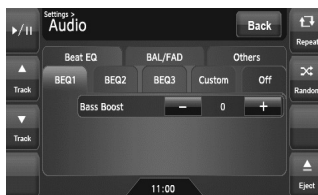

3. Touch the desired Tab key, and perform the adjustment.
See the following sections for details.
 - In the following sections, only the details regarding adjustments are described, procedures to select items are skipped.
4. When the adjustment completes, touch the **[Back]** key to return to the previous screen.

▣ **Setting the Beat EQ**

This system provides 4 types of sound tone adjustment functions. You can select desired function and adjust the effect level.

- The factory default setting is "Off".
- 3-1. Touch the [**Beat EQ**] key to display the Beat EQ tab screen.
 - 3-2. Touch the [**BEQ1**], [**BEQ2**], [**BEQ3**], [**Custom**], or [**Off**] key to select the function you wish to apply.
 - [BEQ1]:**
The bass sound area is emphasized.
 - [BEQ2]:**
The mid sound area is reduced, and the bass and treble sound area are emphasized.
 - [BEQ3]:**
The mid sound area is lowered, and the bass and treble sound area are extremely emphasized.
 - [Custom]:**
You can adjust the sound tone of bass, mid, and treble areas individually. For details, see the following section.
 - [Off]:**
No sound effect is applied.
 - 3-3. When you select an item other than "Custom" and "Off" in step 3-2, adjust the effect level by touching the [-] or [+] key.
Setting range: -3 to +3
 - The factory default setting is "0".

Notes:

- The volume will change each time the Beat EQ function is switched.
- Sufficient effects may not be obtained with some speaker systems. In such cases, adjust the volume.

Adjusting the custom tone

- 3-1. Touch the [**Beat EQ**] key to display the Beat EQ tab screen.
- 3-2. Touch the [**Custom**] key.
- 3-3. Perform the following settings to adjust the sound tone.

● **Adjusting the Bass**

- 3-4. Touch the [**Bass**] key.
- 3-5. Touch the [-] or [+] key of the desired item to adjust the effect level.
 - Gain:** -7 to +7
 - The factory default setting is "0".
 - Frequency:** 50Hz, 100Hz, 200Hz
 - The factory default setting is "100Hz".
 - Q:** 0.7, 1, 1.4, 2
 - The factory default setting is "1".

● **Adjusting the Mid**

- 3-4. Touch the [**Mid**] key.
- 3-5. Touch the [-] or [+] key of the desired item to adjust the effect level.
 - Gain:** -7 to +7
 - The factory default setting is "0".
 - Frequency:** 500Hz, 1kHz, 2kHz
 - The factory default setting is "1kHz".
 - Q:** 0.7, 1, 1.4, 2
 - The factory default setting is "1".

● **Adjusting the Treble**

- 3-4. Touch the [**Treble**] key.
- 3-5. Touch the [-] or [+] key of the desired item to adjust the effect level.
 - Gain:** -7 to +7
 - The factory default setting is "0".
 - Frequency:** 5kHz, 10kHz, 15kHz
 - The factory default setting is "10kHz".
 - Q:** 0.7, 1, 1.4, 2
 - The factory default setting is "1".

▣ **Adjusting the Balance/Fader**

- 3-1. Touch the [**BAL/FAD**] key to display the BAL/FAD tab screen.
 - 3-2. Touch the [◀] or [▶] key of the Balance item to adjust the balance level.
 - [◀]:**
Emphasizes the sound from the left speakers.
 - [▶]:**
Emphasizes the sound from the right speakers.
- Adjustment range: left 12 to right 12
- The factory default setting is "0".

- 3-3. Touch the [▲] or [▼] key of the Fader item to adjust the fader level.

[▲]:

Emphasizes the sound from the front speakers.

[▼]:

Emphasizes the sound from the rear speakers.

Adjustment range: front 12 to rear 12

- The factory default setting is "0".

□ **Setting the Sub Woofer Control**

You can adjust the volume output to the Sub Woofer.

- The factory default setting is "0".

- 3-1. Touch the [Others] key to display the Others tab screen.

- 3-2. Touch the [-] or [+] key of the Sub Woofer Ctrl item to adjust the output level.

Setting range: -6 to +6

□ **Setting the Sub Woofer Phase**

You can reverse the phase of the Sub Woofer output signal.

- The factory default setting is "Normal".

- 3-1. Touch the [Others] key to display the Others tab screen.

- 3-2. Touch the [Reverse] or [Normal] key of the Sub Woofer Phase item to select the phase setting.

□ **Adjusting the High Pass Filter**

You can adjust the cut-off frequency of the High Pass Filter for the front/rear speaker output.

- The factory default setting is "Through".

- 3-1. Touch the [Others] key to display the Others tab screen.

- 3-2. Touch the [◀] or [▶] key of the High Pass Filter item to adjust the setting.

Settings: Through, 60Hz, 90Hz, 120Hz

□ **Adjusting the Low Pass Filter**

You can adjust the cut-off frequency of the Low Pass Filter for the subwoofer output.

- The factory default setting is "Through".

- 3-1. Touch the [Others] key to display the Others tab screen.

- 3-2. Touch the [◀] or [▶] key of the Low Pass Filter item to adjust the setting.

Settings: Through, 120Hz, 90Hz, 60Hz

□ **Setting the Amp Cancel**

When an external amplifier is used, using this function reduces power noises of the audio lines.

- The factory default setting is "Off".

- 3-1. Touch the [Others] key to display the Others tab screen.

- 3-2. Touch the [▼] key to display the next screen.

- 3-3. Touch the [On] or [Off] key of the Amp Cancel item to turn the Amp Cancel function on or off.

□ **Setting the BBE MP**

This function works only for the sound in the USB mode, corrects the distorted waveform of the high-pass area when decoding the digital sound.

- The factory default setting is "Off".

- 3-1. Touch the [Others] key to display the Others tab screen.

- 3-2. Touch the [▼] key to display the next screen.

- 3-3. Touch the [◀] or [▶] key of the BBE MP item to set the correction level.

Settings: Off, Low, Mid, High

□ **Turning on/off the Magna Bass Extend**

The Magna Bass Extend does not adjust the low sound area like the normal sound adjustment function, but emphasizes the deep bass sound area to provide you with a dynamic sound.

- The factory default setting is "Off".

- 3-1. Touch the [Others] key to display the Others tab screen.

- 3-2. Touch the [▼] key to display the next screen.

- 3-3. Touch the [On] or [Off] key of the Magna Bass EX item to turn the Magna Bass Extend function on or off.

□ Setting the Audio ATTenuation

The audio output can be attenuated when a voice interrupt of the navigation system arises.

- The factory default setting is “**High**”.
- 3-1. Touch the [**Others**] key to display the Others tab screen.
 - 3-2. Touch the [**▼**] key to display the next screen.
 - 3-3. Touch the [**◀**] or [**▶**] key of the Audio ATT item to set the volume level when a voice interrupt arises.
Settings: Mute, Low, Mid, High

General Settings

□ Displaying the General screen

You can customize the various settings of this unit from the General screen.

1. Touch the [**SET**] key.
The Settings screen appears.
2. Touch the [**General**] key.
The General screen appears.



3. Touch the desired Tab key, and perform the adjustment.
See the following sections for details.
 - In the following sections, only the details regarding adjustments are described, procedures to select items are skipped.
4. When the adjustment completes, touch the [**Back**] key to return to the previous screen.

□ Setting Camera Interrupt

When the optional Rear Vision Camera is connected to this unit, the rear view image is displayed on the screen when the gear lever is put in the reverse gear position.

- The factory default setting is “**Off**”.
- 3-1. Touch the [**Display**] key to display the Display tab screen.
 - 3-2. Touch the [**NTSC**], [**PAL**], or [**Off**] key of the Camera Interrupt item to set to “**NTSC**”, “**PAL**”, or “**Off**”.
[NTSC]:
Turn on the function with the NTSC video system.
[PAL]:
Turn on the function with the PAL video system.
[Off]:
Turn off the function.

□ Setting Camera Warning

The following warning message is displayed during use of the Rear Vision Camera: “Make sure of safety around your vehicle”.

- The factory default setting is “**On**”.

Note:

- This setting is disabled when the Camera Interrupt feature is set to Off.

- 3-1. Touch the [**Display**] key to display the Display tab screen.
- 3-2. Touch the [**On**] or [**Off**] key of the Camera Warning item to turn the Camera Warning function on or off.

□ Setting the AUX input (NTSC/PAL)

- The factory default setting is “**PAL**”.

Note:

- This setting is applied only to the AUX video input.
- If nonstandard video signals are input, the video image may be disturbed.
- When you set to “**Auto**”, the video image may be disturbed temporarily depending on the input video signal.

- 3-1. Touch the [**Display**] key to display the Display tab screen.
- 3-2. Touch the [**Auto**], [**NTSC**], or [**PAL**] key of the AUX input item to set the VTR system.

❑ **Setting the Beep**

The sound heard when you make operations is called “beep”. The system can be set so that it does not produce this beep sound.

- The factory default setting is “On”.

- 3-1. Touch the [**System**] key to display the System tab screen.
- 3-2. Touch the [**On**] or [**Off**] key of the Beep item to turn the Beep function on or off.

❑ **Setting the Blink LED**

You can set the unit to blink the Blink LED indication when the ACC power is turned off.

- The factory default setting is “Off”.
- 3-1. Touch the [**System**] key to display the System tab screen.
 - 3-2. Touch the [**On**] or [**Off**] key of the Blink LED item to turn the Blink LED function on or off.

❑ **Confirming the DivX Registration Code and DivX URL**

When you download a DivX VOD (Video-on-Demand) file from a web site, entering the registration code of your playback system may be required to authorize the file. You can confirm the registration code of your system and the URL information by the following operation.

- 3-1. Touch the [**System**] key to display the System tab screen.
- 3-2. Confirm the displayed information of the DivX Registration Code and DivX URL items.

Note:

- *The DivX registration code is not displayed when a disc is set in the DVD player.*

❑ **Setting the TEL Switch**

When a telephone is connected to this unit using the optional adapter box, you can listen to your telephone calls on your car speakers.

- The factory default setting is “Off”.
- 3-1. Touch the [**System**] key to display the System tab screen.
 - 3-2. Touch the [▼] key to display the next screen.
 - 3-3. Touch the [**On**], [**Off**], or [**Mute**] key of the TEL Switch item to set this function.
On:
The telephone calls are output from the car speaker.
Off:
The telephone interrupts are ignored.
Mute:
The sound from this unit is muted during telephone calls.

□ **Setting the TEL Speaker**

You can select the speaker which the telephone calls are output.

- The factory default setting is "**Right**".
- 3-1. Touch the **[System]** key to display the System tab screen.
 - 3-2. Touch the **[▼]** key to display the next screen.
 - 3-3. Touch the **[Left]** or **[Right]** key of the TEL Speaker item to select the speaker.

Left:
The telephone calls are output from the front left speaker.

Right:
The telephone calls are output from the front right speaker.

□ **Performing the System Check**

You can perform the system check by the following operation.

- 3-1. Touch the **[System]** key to display the System tab screen.
- 3-2. Touch the **[▼]** key to display the next screen.
- 3-3. Touch the **[▶]** key of the System Check item. The System Check screen is displayed.
- 3-4. Touch the **[Start system check]** key to perform the system check manually. The system will be restarted after performing the system check.

□ **Resetting the navigation system**

You can reset the navigation system.

- 3-1. Touch the **[System]** key to display the System tab screen.
- 3-2. Touch the **[▼]** key to display the next screen.
- 3-3. Touch the **[▶]** key of the System Check item.
- 3-4. Touch the **[Reset NAVI module.]** key to reset the navigation system.

□ **Setting the anti-theft function (CATS)**

"CATS" is the acronym of "Clarion Anti-Theft System". When you set a PIN code (called as "Personal Code"), a theft is prevented by disabling the operation of the unit at the theft. In addition, set the Blink LED function to improve the effect of the CATS function (see page 48).

Setting your Personal Code

- 3-1. Touch the **[System]** key to display the System tab screen.
- 3-2. Touch the **[▼]** key to display the next screen.
- 3-3. Touch and hold the blank area just below the **[▶]** key of the System Check item for more than 2 seconds. The Personal Code screen appears.
 - When a Personal Code is already set, the Erase Code screen will appear. Retry this operation after erasing the old Personal Code.
- 3-4. Enter your desired 4-digit Personal Code by touching the **[0]** to **[9]** keys, then touch the **[ENT]** key.
 - Touch the **[BS]** key when you make a mistake in entering.
- 3-5. Enter the same Personal Code again for confirmation, then touch and hold the **[ENT]** key for more than 2 seconds. The entered Personal Code will be set, and it will return to the previous screen.

Note:

- Write down your Personal Code in case you forget it.

Erasing the Personal Code

- 3-1. Touch the **[System]** key to display the System tab screen.
- 3-2. Touch the **[▼]** key to display the next screen.
- 3-3. Touch and hold the blank area below the **[▶]** key of the System Check item for more than 2 seconds. The Erase Code screen appears.
- 3-4. Enter the Personal Code currently set by touching the **[0]** to **[9]** keys, then touch and hold the **[ENT]** key for more than 2 seconds. The message "**Personal Code has been erased**" appears, and it will return to the previous screen.

When the ENTER PERSONAL CODE screen appears

The Personal Code screen will be displayed when turning the ACC power on after performing the following operations:

- The car battery was replaced.
- The backup power was cut off.
- The Reset button was pressed.

Note:

- *If you forgot your Personal Code, please consult your dealer or an authorized Clarion service center.*

1. Enter your Personal Code currently set.
2. When the correct Personal Code is entered, the unit will restart from the initial startup screen.

Note:

- *When you enter a wrong Personal Code, the message "Code Incorrect" is displayed and the Personal Code entry is prohibited for a while. This prohibited time is changed according to the number of times of wrong code entry as follows:*
- *1 to 6 times: 15 seconds*
- *7 times or more: 15 minutes*

Setting the Auto Antenna

When an auto antenna which is extended automatically is used, you can set so that it is automatically extended/collapsed according to the power setting of this unit.

1. Touch the **[SET]** key to display the Settings screen.
2. Touch and hold the **[Auto]** or **[Down]** key of the Antenna item for more than 1 second to set this function.

Auto:

The auto antenna function is turned on.

Down:

The antenna is collapsed.

Adjusting the Monitor

You can customize the various monitor settings by the following operations.

Setting the Screen mode

The system has two screen modes: the Day mode and Night mode. Each mode has the own dimmer setting. You can select these modes temporarily by performing the following operation.

- The factory default setting is "Auto".
1. Press the **[SRC]** button to display the Source screen.
 2. Touch the **[Day]**, **[Night]**, or **[Auto]** key to set the Screen mode.

[Day]:

Set the dimmer level temporarily to the Day mode (brighter).

[Night]:

Set the dimmer level temporarily to the Night mode (dimmer).

[Auto]:

The dimmer level is changed according to the status of the car light:

When the car light is off: Day mode

When the car light is on: Night mode

Note:

- *When the Night Mode setting of the navigation system is set to "Automatic", this setting also works upon the Color mode of the navigation system.*

□ Adjusting the Dimmer, Bright, Color, Contrast, and Hue level

Note:

- The *Bright, Color, Contrast, and Hue* settings can be adjusted only when a video image is displayed on the screen, and the car is stopped with applying the parking brake.
 - The *Hue* setting can be adjusted only when the *NTSC* mode is selected.
 - The navigation screen has own dimmer setting separately from the AV screen. The dimmer adjustment in a mode does not affect each other screen.
 - The *Rear Vision Camera* image cannot be adjusted directly. Perform the adjustments when displaying a video image of the other source.
1. Touch the **[SET]** key to display the Settings screen.
 2. Touch the **[Monitor ADJ]** key to display the Monitor screen.

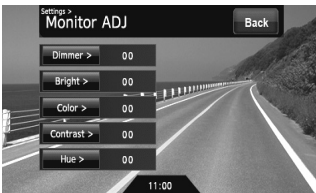

3. Touch the **[Dimmer]**, **[Bright]**, **[Color]**, **[Contrast]**, or **[Hue]** key you wish to adjust, then touch the **[-]** or **[+]** key to adjust the level.

[Dimmer]:

Adjusts the panel brightness when the car lights are ON or OFF.

[+]: Press to make image brighter.

[-]: Press to make image dimmer.

[Bright]:

Adjusts the brightness of the display.

[+]: Press to make image brighter.

[-]: Press to make image dimmer.

[Color]:

Adjusts the color saturation.

[+]: Press to increase color depth.

[-]: Press to decrease color depth.

[Contrast]:

Adjusts the contrast of the display.

[+]: Press to make contrast higher.

[-]: Press to make contrast lower.

[Hue]:

Adjust the tone of color (red or green is emphasized).

[+]: Press to increase green.

[-]: Press to increase red.

4. When the adjustment completes, touch the **[Back]** key to return to the previous screen.

8. TROUBLESHOOTING

If you have a problem with this system, check the following items to resolve it. See also our homepage (www.clarion.com) for additional information.

General

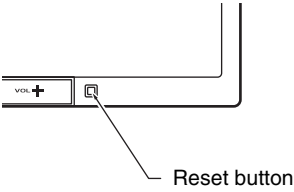
Problem	Cause	Measure
Power does not turn on. (No sound is produced.)	Fuse is blown.	Replace with a fuse of the same amperage. If the fuse blows again, consult your store of purchase.
	Incorrect wiring.	Consult your store of purchase.
Nothing happens when buttons are pressed. Display is not accurate.	The microprocessor has malfunctioned due to noise, etc.	Turn off the power. Press the Reset button with a thin rod. Note: When the Reset button is pressed, turn off the ACC power.  <ul style="list-style-type: none"> The frequencies of radio stations, setting data, etc. stored in memory are not cleared even when the Reset button is pressed.
The remote control unit does not work.	Direct rays of the sun fall on the light-receptive part of the remote control unit.	When direct rays of the sun fall on the light-receptive part of the remote control unit, it may not work.
	The battery of the remote control unit is dead or there is no battery in the remote control unit.	Check the battery of the remote control unit.
The display is dark.	The Dimmer control is too low.	Adjust the Dimmer properly.
	The operating condition is not good.	The temperature inside the vehicle may be 0°C or lower. Set to an appropriate temperature (25°C or so) and check it again.
	The headlight of the vehicle is lit.	The display is made dark at night to prevent the glare (when the headlight is the vehicle is lit in the daytime, the display gets dark).
There are red, green and blue points in the display.	_____	This is not a failure, but a phenomenon peculiar to a liquid crystal display (The liquid crystal display is produced according to technology with very high precision. Note that, though there are effective pixels of 99.99% or more, pixel missing or normally lit pixels account for 0.01%).

Problem	Cause	Measure
Disc cannot be loaded.	Another disc is already loaded.	Eject the disc before loading the new one.
	There is a foreign matter already in place.	Eject the foreign matter forcibly.
Sound skips or is noisy.	Disc is dirty.	Clean the disc with a soft cloth.
	Disc is heavily scratched or warped.	Replace with a disc with no scratches.
	MP3/WMA/AAC files are not encoded properly.	Use MP3/WMA/AAC files encoded properly.
Sound is bad directly after power is turned on.	Water droplets may form on the internal lens when the car is parked in a humid place.	Let dry for about 1 hour with the power on.
The image is not displayed.	The parking brake is not engaged.	Check that the parking brake is engaged.
Disc cannot be played with the display " Parental Violation " shown.	The view is limited.	Release the view limitation or change the parental level. See the subsection "Setting up the parental level" (page 25).
Disc cannot be played.	File system is not correct.	Use ISO9660 level 1/2, Romeo, Joliet, or Apple ISO file system for CD-R/RW, or UDF for DVD±R/RW.
The color of the display is light or a shade of color is not good.	The color is not adjusted adequately.	Check that the Bright, Color, Contrast, and Hue are adjusted properly.

USB Devices

Problem	Cause	Measure
USB device cannot be inserted.	The USB device has been inserted with wrong direction.	Reversing the connection direction of the USB device, try it again.
	The USB connector is broken.	Replace with a new USB device.
USB device is not recognized.	The USB device is damaged.	Disconnect the USB device and reconnect. If the device is still not recognized, try replacing with a different USB device.
	Connectors are loose.	
No sound heard with the display "No File" shown.	No MP3/WMA/AAC file is stored in the USB device.	Store these files properly in the USB device.
Sound skips or is noisy.	MP3/WMA/AAC files are not encoded properly.	Use MP3/WMA/AAC files encoded properly.
The iPod's video image is disturbed.	The TV Signal setting of the iPod is not set correctly.	Set the TV Signal setting (NTSC/PAL) of the iPod correctly.

9. ERROR DISPLAYS

If an error occurs, one of the following displays is displayed. Take the measures described below to solve the problem.

DVD Player

Display	Cause	Measure
Error 2	A disc is caught inside the DVD player and is not ejected.	This is a failure of DVD player's mechanism. Consult your store of purchase.
Error 3	A disc cannot be played due to scratches, etc.	Replace with a non-scratched, non-warped disc.
Error 6	A disc is loaded upside-down inside the DVD player and does not play.	Eject the disc then reload it properly.
	No MP3/WMA/AAC/DivX file is recorded on the disc.	Write these files properly onto a disc.
Parental Violation	Parental level error	Set the correct Parental level.
Wrong Region	Region code error	Eject the disc, and replace correct region code disc.
DRM	WMA files protected by DRM are played.	Perform the operation such as skipping a file. (Repeat and random playback mode may be canceled.)
Not Support	Files not supported by this unit are played.	

Display	Cause	Measure
Error 2	The connected USB device is not supported.	If the USB device is frozen, disconnect it, reset it, and reconnect it again. Connect a proper USB device.
Error 3 (USB memory)	An error occurred when controlling the USB device.	Disconnect the USB device, and reconnect it again.
Error 3 (iPod)	The selected category has no track data.	Touch the [▲ (Track)] key. If the error is not cleared, disconnect the iPod, and reconnect it again.
	The iPod is frozen.	Disconnect the iPod, reset it, and reconnect it again.
Error 5 (iPod)	The connected iPod is not recognized.	Disconnect the iPod, and reconnect it again. If the iPod is still not recognized, try replacing with a different iPod.
		If the iPod is frozen, disconnect it, reset it, and reconnect it again.
Bus Error	Over-current or data error is detected.	Turn off the ignition switch, disconnect the device, restart the engine and reconnect it again. If the device is still not recognized, try replacing with a different device.
Device Error	The device is connected via the USB Hub.	Disconnect the device, and reconnect directly to the USB connector of this unit without using the USB Hub.
DRM	WMA files protected by DRM are played.	Perform the operation such as skipping a file. (Repeat and random playback mode may be canceled.)
Not Support	Files not supported by this unit are played.	

If an error display other than the ones described above appears, press the Reset button. If the problem persists, turn off the power and consult your store of purchase.

- The frequencies of radio stations, setting data, etc. stored in memory are not cleared even when the Reset button is pressed.

10. SPECIFICATIONS

FM Tuner

Frequency Range: 87.00 MHz to 108.00 MHz
 Usable Sensitivity: 9 dBf
 50dB Quieting Sensitivity: 15 dBf
 Alternate Channel Selectivity: 70 dB
 Stereo Separation (1 kHz): 38 dB
 Frequency Response (± 3 dB): 30 Hz to 15 kHz

AM Tuner

Frequency Range: 531 kHz to 1629 kHz
 Usable Sensitivity: 28 dB μ V

DVD Player

System:
 Digital Versatile Disc System with CDDA capable
 Usable discs:
 DVD video disc, Compact disc
 Frequency Response:
 20 Hz to 20 kHz (CD) (± 1 dB)
 Signal to Noise Ratio: 100 dB (1 kHz)
 Dynamic Range: 100 dB (1 kHz)
 Distortion: 0.006%

USB

Specification: USB 2.0 Full Speed
 File system: FAT12/16/32, non-VFAT-compliant
 Playable audio format:
 MP3 (.mp3): MPEG 1/2 Audio Layer-3
 WMA (.wma): Ver. 7/8/9.1/9.2
 AAC (.m4a): AAC format encoded by iTunes and iTunes+ only
 Maximum number of folders: 512
 Maximum number of files: 255 (for a folder)
 Maximum folder hierarchy: 8 levels (including Root)
 Maximum power supply: 500 mA

Audio Amplifier

Maximum power output:
 200 W (50 W \times 4)
 Speaker impedance: 4 Ω (4 to 8 Ω allowable)

Input

Audio input sensitivity:
 High: 0.65 V (at 2 V output)
 Mid: 1.3 V (at 2 V output)
 Low: 2.0 V (at 2 V output)
 (input impedance 10 k Ω or greater)
 Video input:
 1.0 \pm 0.2 Vp-p (input impedance 75 Ω)

Video Output

Video output:
 1.0 \pm 0.2 Vp-p (output impedance 75 Ω)

LCD Monitor

Screen Size: 7-inch wide type
 152 mm Width \times 85 mm Height
 Display method:
 Transmission type TN liquid crystal display
 Drive method: TFT (thin-film transistor)
 active matrix driving
 Pixels: 336,960 (1440 \times 234)

General

Power source voltage:
 14.4 V DC (10.8 to 15.6 V allowable)
 Ground: Negative
 Current consumption: 3.5 A (1 W)
 Auto Antenna Rated Current: 500 mA less
 Dimensions of the Main Unit:
 178 mm Width \times 100 mm Height \times 160 mm Depth
 Weight of the Main Unit: 2.6 kg
 Dimensions of the Remote Control Unit:
 43.4 mm Width \times 12.5 mm Height \times 112.7 mm Depth
 Weight of the Remote Control Unit:
 60 g (including battery)

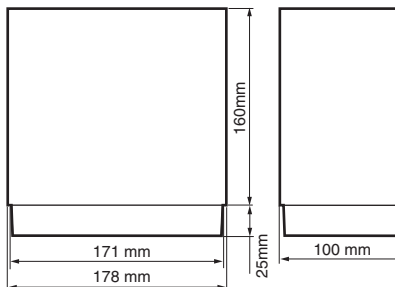

Note:

- Specifications comply with JEITA Standards.
- Specifications and design are subject to change without notice for further improvement.

INSTALLATION AND WIRE CONNECTION MANUAL

1. SAFETY PRECAUTIONS

Symbol Identification

This manual uses symbols and icons to indicate safety precautions and concerns during the installation procedure. Be sure to carefully read and understand each precaution prior to beginning the installation.

⚠ WARNING

This symbol is intended to alert the user to the presence of important operating instructions. Failure to heed the instructions may result in severe injury or death.

⚠ CAUTION

This symbol is intended to alert the user to the presence of important operating instructions. Failure to heed the instructions can result in injury or material damage.

Before Use

⚠ WARNING

- Confirm the battery voltage of the vehicle to be installed. This unit is designed only for vehicles with DC 12V power supply.
- Disconnect the negative terminal of the battery before connecting wires, otherwise an electric shock, injury by short circuit may occur.

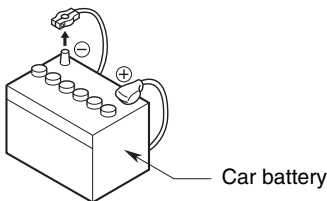

Installation Precautions

⚠ WARNING

- When installing the unit to a vehicle with an airbag system, never install it in a place where it may affect the operation of the airbag.
- Do not install this unit in the following locations:
 - A location interfering with the driver's visual range or operation.
 - A location where the gear shift or brake pedal are hindered.
 - A location where passengers are at risk.
 - An unstable location, or where the system may fall.

⚠ CAUTION

- Do not install the system in the locations described below. This may cause a fire, accident or electrical shock:
 - A location exposed to rain or dust.
 - An unstable location, or where the system may fall.
- Do not install this unit in a place exposed to direct sunlight, heat or a place where the vent holes or heat radiation holes are covered.
- When you install the antenna, mount it in a place where the elements of the antenna do not protrude beyond the edge of the front, back, left and right of the vehicle. If it comes in contact with pedestrians, it may cause an accident.

Installation Notes

⚠ WARNING

- Please note the position of pipes, tanks and electrical wirings before installing the unit into the vehicle; failure in avoiding these may cause a fire or malfunction.

⚠ CAUTION

- Use only the supplied parts. If unspecified parts are used, they may cause damage.
- Any holes made in the body of the vehicle should be sealed with a silicon adhesive. If exhaust fumes or water penetrates into the vehicle, this may cause an accident.
- Fasten the bolts securely when installing the unit. If the bolts are loose an accident or malfunction could occur.

Connection Notes

⚠ WARNING

- Loom all cables according to the instruction manual, so as not to hinder operation.
- Wire the connecting cords/cables away from high temperature areas. If the coatings of the cables melt, it could cause an accident/fire by a short circuit. Take care when wiring in the engine compartment.
- When wiring the connecting cables in a vehicle with an airbag system, never feed the cables through a place where it may affect the operation of the airbag. An airbag not operating correctly in an emergency may cause increased injury.

⚠ CAUTION

- Verify wires with a digital multi-meter prior to making any connections. Many new vehicles use multiplexed and/or low voltage circuits that can be damaged if a test light or logic probe is used.
- Connect cables appropriately. If a wrong connection is made, this may cause a fire or accident.

- When passing cables through the body of the vehicle, use non-conductive grommets. If the coatings of the cables are worn out by rubbing, this may cause an accident, fire or a short circuit.
- After wiring cables, fix them with insulation tape.
- Be sure to switch off the vehicle when connecting or disconnecting cords to/from the unit, otherwise an electric shock, injury or accident may occur.

2. PACKAGE CONTENTS

- ① Main unit
- ② Owner's Manual (this book)
- ③ Navigation System Operation Manuals
- ④ Power supply cord
- ⑤ RCA pin cord
- ⑥ Bag for accessories

Flat head screw (M5 × 8 mm)	8
Hexagonal bolt (M5 × 8 mm)	8
Electro tap	1
Rubber cap (for RCA pin cord)	14
Lead holder.....	3
Double-sided tape	
for fastening GPS antenna	1
- ⑦ Remote control unit
- ⑧ Battery
- ⑨ Finisher
- ⑩ GPS antenna

3. GENERAL CAUTIONS

- Do not open the case. There are no user-serviceable parts inside. If you drop anything into the unit during installation, consult your dealer or an authorized Clarion service center.

4. CAUTIONS ON INSTALLATION

- Prepare all articles necessary for installing the main unit before starting.
- This model features an operation panel that slides forward. On some types of cars, the operation panel may make contact with the dashboard or gearshift lever, in which case it cannot be installed. Before installing, check that the unit will not hamper operation of the gearshift lever or obstruct your view before selecting the installation location. (Figure 2)

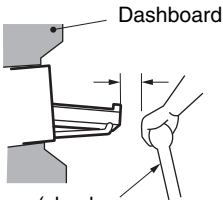

Gearshift lever (check that it does not touch the LCD.)

Figure 2

- Install the unit within 30° of the horizontal plane. (Figure 3)

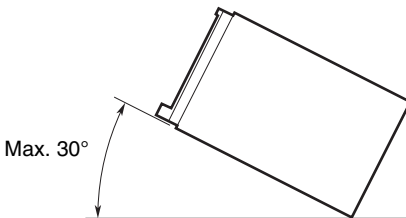

Figure 3

- If you have to do any modification on the car body, such as drilling holes, consult your car dealer beforehand.

- Use the included screws for installation. Using other screws can cause damage. (Figure 4)

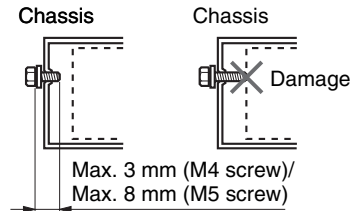

Figure 4

- This unit has a fan motor in the right side of the main unit so as not to raise the temperature in the main unit. When the fan motor vent is covered with cords or mounting bracket, it may cause a malfunction. Be sure not to cover it when wiring cords. (Figure 5)

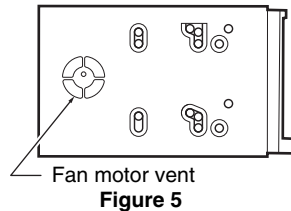

Figure 5

5. INSTALLING THE MAIN UNIT

This unit is designed for fixed installation in the dashboard.

- When installing the main unit in NISSAN vehicles, use the parts attached to the unit and follow the instructions in Figure 6.

When installing the main unit in TOYOTA vehicles, use the parts attached to the vehicle and follow the instructions in Figure 7.

- Wire as shown in Section 9 (see page 64).
- Reassemble and secure the unit in the dashboard and set the face panel and center panel.

Mounting Screw Holes (Side View of the Main Unit)

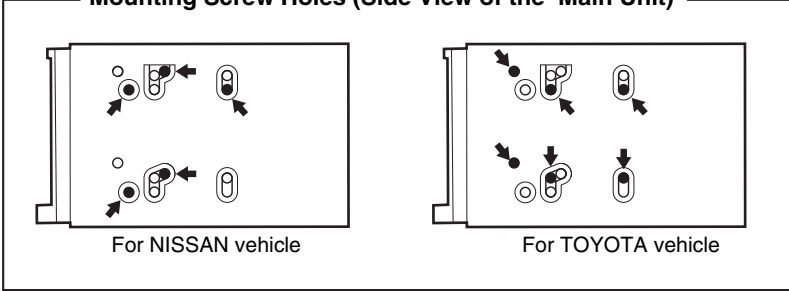

Installing the Main Unit in a NISSAN Vehicle

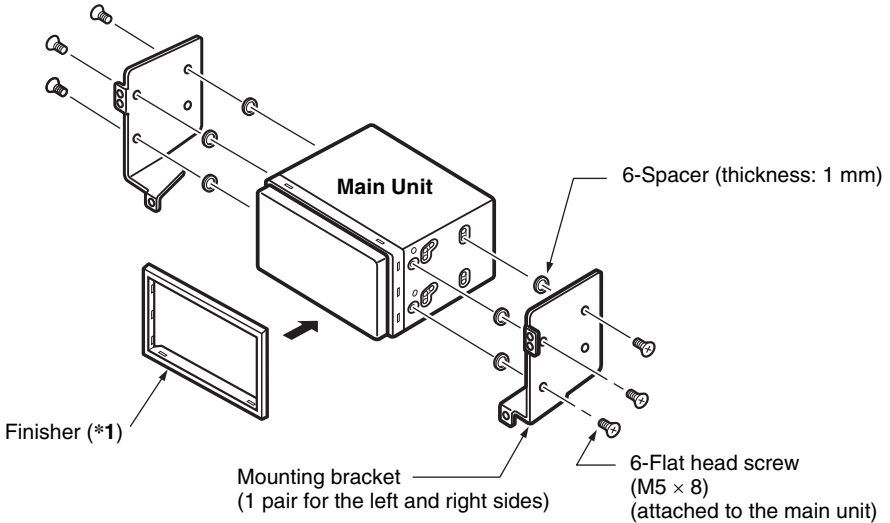

Figure 6

Note:

*1 Position the face panel with its wide edge at the bottom. Fit the edge into the groove of the main unit.

Installing the Main Unit in a TOYOTA Vehicle

Install by using parts attached to the vehicle. (Screws marked ★ are attached to the vehicle.)

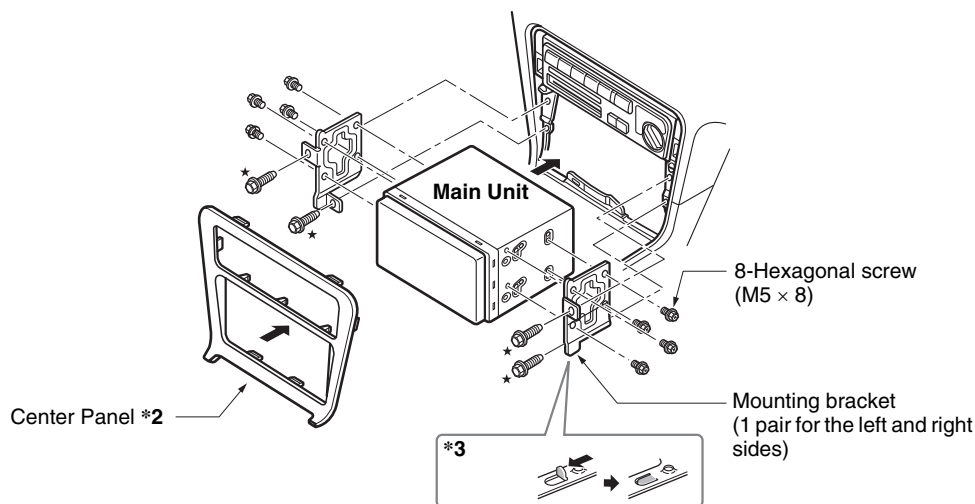

Figure 7

Note:

*2 Some panel openings are too small for the unit depending on the vehicle type and model. In such a case, trim the upper and lower sides of the panel frame by about 0.5 to 1.5 mm so the unit can be inserted smoothly.

*3 If a hook on the installation bracket interferes with the unit, bend and flatten it with a nipper or similar tool.

Typical Mounting Brackets

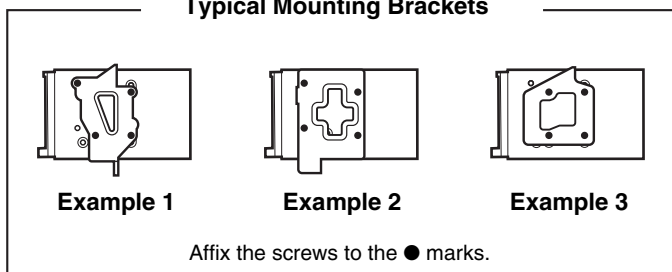

Vehicles other than NISSAN and TOYOTA

In some cases the center panel may require modification. (Trimming, filing, etc.)

6. REMOVING THE MAIN UNIT

When the main unit is to be removed, disassemble it in the reverse of the order in "INSTALLING THE MAIN UNIT" (see page 60).

7. CAUTIONS ON WIRING

- Be sure to turn the power off before wiring. Be particularly careful where you route the wires.
- Keep them well away from the engine, and exhaust pipe, etc. Heat may damage the wires.
- If the fuse should blow, check to see if the wiring is correct.
If a fuse is blown, replace it with a new one of the same specification as the original.
- To replace the fuse, remove the old fuse of the power supply cord and insert the new one. (Figure 8)

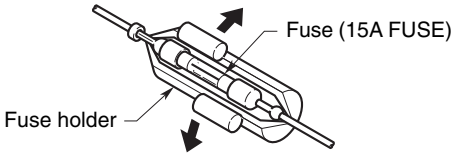

Figure 8

Note:

- There are various types of fuse holder. Do not let the battery side touch other metal parts.

⚠ CAUTION

After the connection, fix the cord by a clamp or insulation tape for protection.

8. Installing the GPS Antenna

⚠ WARNING

- Do not install the GPS antenna in a place where it may interfere with the operation of the airbag or hinder the driver's visual range.
- Do not use the navigation system with the GPS antenna cord cut off. The power cables in the cord may be short-circuited.

Note:

- The supplied GPS antenna is for installing inside the vehicle. Do not install it outside the vehicle.
 - Install the GPS antenna more than 50 cm away from the main unit, other audio devices such as CD player, and a radar detector. If it is installed near these devices, GPS reception may be impaired.
 - To improve the GPS signal reception, install the GPS antenna horizontally on a flat plane.
 - Do not wax or paint the cover of the GPS antenna. This may reduce the performance of the GPS antenna.
 - Install the GPS antenna at least 10 cm away from the windshield.
 - Wipe off the dirt of the mounting surface before installing the GPS antenna.
- Stick the double-sided tape to the bottom face of the GPS antenna.

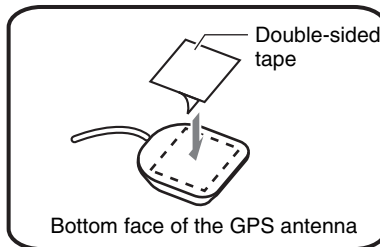

- Mount the GPS antenna.
Stick it surely on a flat plane of the passenger-side dashboard where GPS signal interruption is minimized.
- Wire the GPS antenna cord.
Fasten the cord using the cord holders.

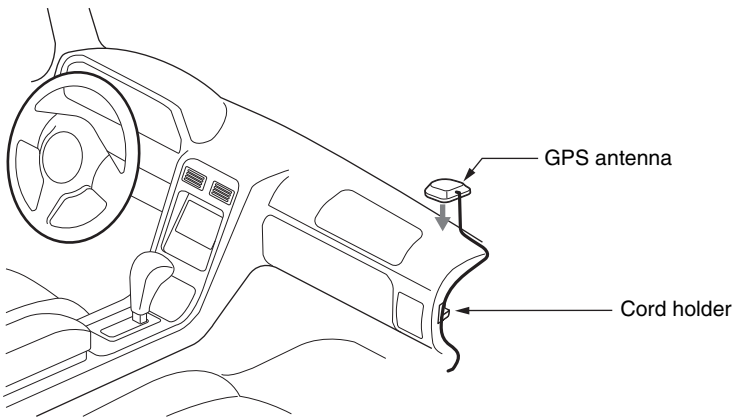

(Shows an example in case of the left-hand traffic.)

9. WIRE CONNECTION

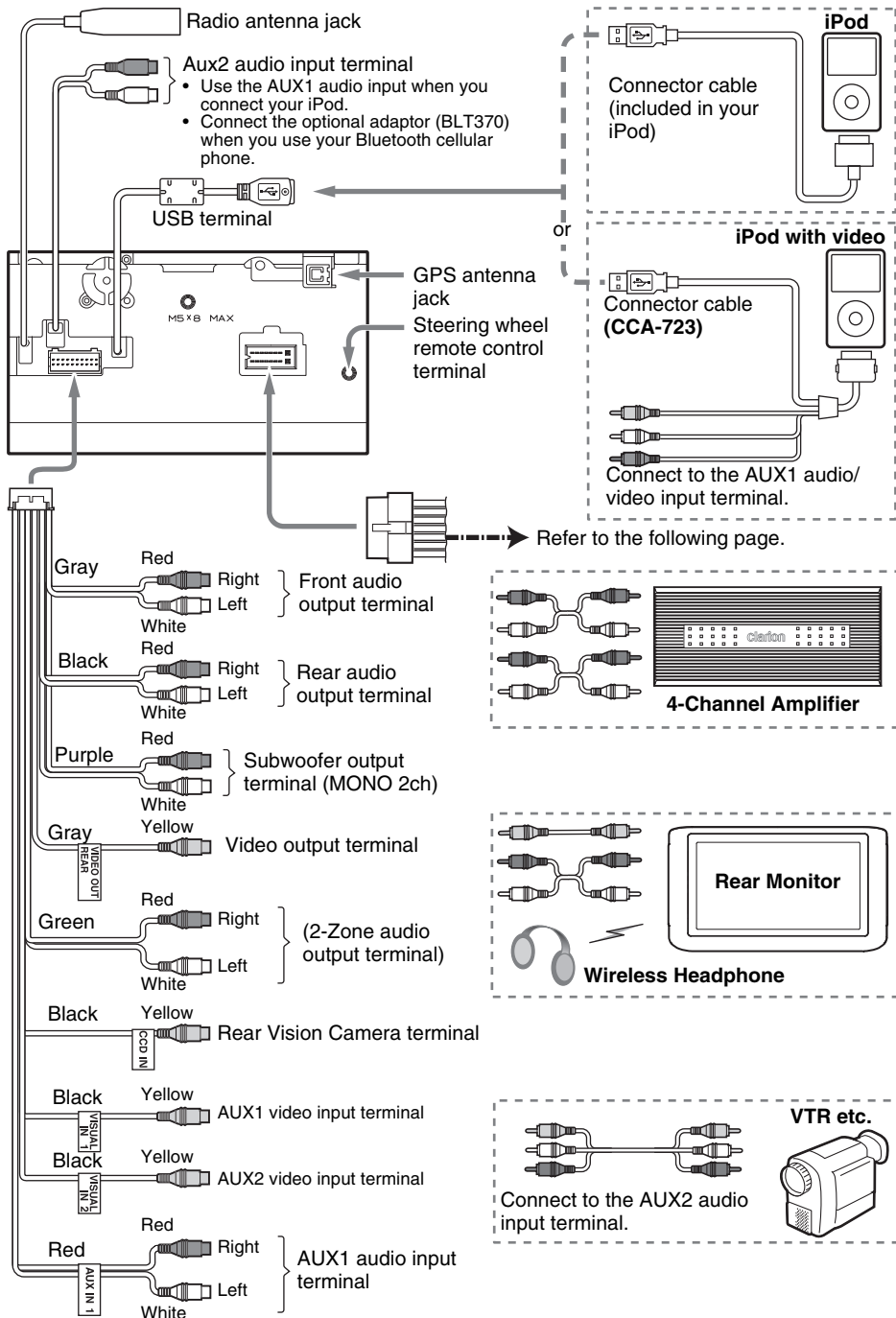

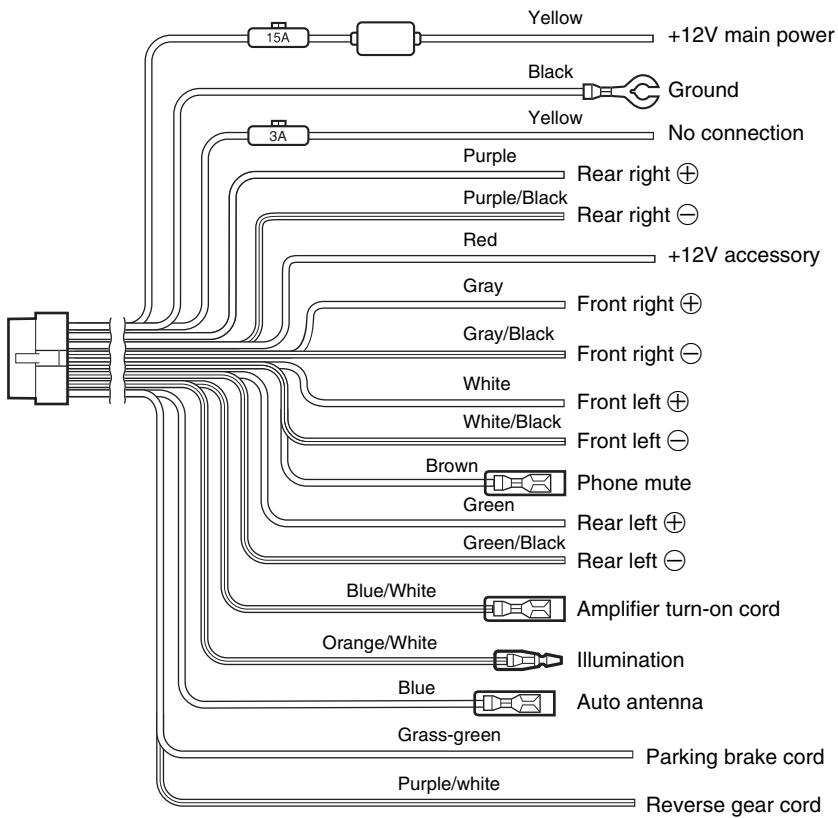

See next page for how to connect the parking brake cord.

● Connecting the parking brake cord

Connect the cord to parking brake lamp ground in the meter panel.

Note:

- Connecting the parking brake cord to lamp ground allows you to watch video images when the parking brake is engaged.
- When the parking brake cord is not connected, the monitor will not display video images.
- If "Audio Only" appears on the screen just after turning on the ACC power of the car, release the parking brake while confirming safety, and then engage the parking brake again.

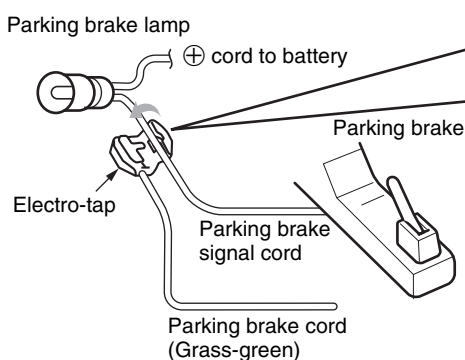

● How to attach the electro-tap

1. Place the Parking brake cord at the stopper, and fold it back in the direction of the arrow.
2. Pass the Parking brake signal cord through, and fold it back in the direction of the arrow.

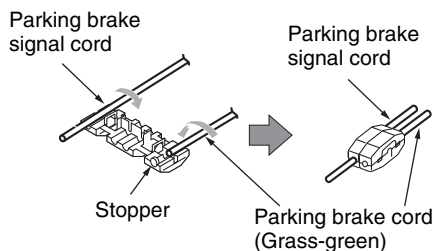

Connecting the Accessories

● Connection to the Rear Vision Camera for vehicle

The Rear Vision Camera for vehicle can be connected to Rear Vision Camera video input terminal of the RCA pin cord. For detailed information, refer to the instruction sheet or manual for the Rear Vision Camera.

Note:

- Be sure to connect the reverse gear cord to the vehicle's relevant terminal.
- Connect the Rear Vision Camera to the RCA pin cord; if not, the screen turns black while the gearshift lever is in the reverse gear position.
- The power supply box CAA185 (sold separately) is required for connection of the main unit and the Rear Vision Camera.

● Bluetooth Cellular Phone

Use the Telephone Adapter BLT370, and connect it to the AUX2 audio input terminal and the PHONE MUTE code. For detailed information, refer to the instruction manual of the BLT370.

Clarion Co., Ltd.

All Rights Reserved. Copyright © 2009: Clarion Co., Ltd.



QY-5010K
280-8821-00