

# Clarion

Owner's manual

使用说明书

사용 설명서

## VXZ756

DVD/VCD/CD/WMA/MP3 Receiver/  
CeNET Control

DVD/VCD/CD/WMA/MP3接收器/CeNET控制

DVD/VCD/CD/WMA/MP3리시버/CeNET컨트롤

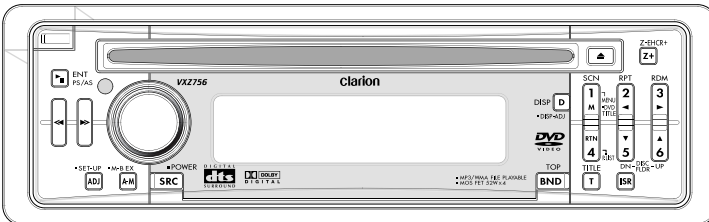

Thank you for purchasing this **Clarion** product.

- \* Please read this owner's manual in its entirety before operating this unit.
- \* After reading this manual, be sure to keep it in a handy place (e.g., glove compartment).
- \* This manual includes the operating procedures of the CD changer and TV tuner connected via the CeNET cable. The CD changer and TV tuner have their own manuals, but no explanations for operating them are described.

# Contents

<b>1. FEATURES</b> .....	<b>2</b>
<b>2. PRECAUTIONS</b> .....	<b>3</b>
Handling Compact Discs .....	3
<b>3. DVD VIDEO SYSTEM</b> .....	<b>4</b>
<b>4. CONTROLS</b> .....	<b>5</b>
<b>5. NOMENCLATURE</b> .....	<b>6</b>
Names of the Buttons and their Functions .....	6
Major Button Operations When External Equipment is Connected to This Unit .....	7
Display Items .....	8
LCD Screen .....	8
<b>6. DCP</b> .....	<b>9</b>
<b>7. REMOTE CONTROL</b> .....	<b>10</b>
Buttons Used in the DVD Mode .....	10
Inserting the Batteries .....	11
Functions of the Remote Control Unit Buttons .....	12
<b>8. OPERATIONS</b> .....	<b>13</b>
Basic Operations .....	13
Radio Operations .....	16
DVD Operations .....	17
DVD-Video Operations .....	18
Watching a video CD (V-CD) .....	22
Listening to a CD .....	25
Listening to an MP3/WMA .....	26
Changing Initial Settings such as Menu Language, etc. ....	31
Common Operations .....	40
<b>9. OPERATIONS OF ACCESSORIES</b> .....	<b>43</b>
CD Changer Operations .....	43
TV Operations .....	45
<b>10. IN CASE OF DIFFICULTY</b> .....	<b>47</b>
<b>11. ERROR DISPLAYS</b> .....	<b>48</b>
<b>12. SPECIFICATIONS</b> .....	<b>49</b>

## 1. FEATURES

- DVD VIDEO/VCD/CD Playback
- 5.1ch DTS/Dolby Digital Built-in Decoder
- MP3 and WMA File Playable with ID3-TAG and WMA-TAG Display
- 24 Bit Digital to Analog Converter
- MAGNA BASS EX for Dynamic Bass Tuning, Volume Level Dependent
- MOS-FET High Power 52W x 4

## 2. PRECAUTIONS

1. When the inside of the car is very cold and the player is used soon after switching on the heater moisture may form on the disc or the optical parts of the player and proper playback may not be possible. If moisture forms on the disc, wipe it off with a soft cloth. If moisture forms on the optical parts of the player, do not use the player for about one hour. The condensation will disappear naturally allowing normal operation.
2. Driving on extremely bumpy roads which cause severe vibration may cause the sound to skip.
3. This unit uses a precision mechanism. Even in the event that trouble arises, never open the case, disassemble the unit, or lubricate the rotating parts.

### ⚠ CAUTION

**USE OF CONTROLS, ADJUSTMENTS, OR PERFORMANCE OF PROCEDURES OTHER THAN THOSE SPECIFIED HEREIN, MAY RESULT IN HAZARDOUS RADIATION EXPOSURE.**



**THE COMPACT DISC PLAYER and MINI DISC PLAYER SHOULD NOT BE ADJUSTED OR REPAIRED BY ANYONE EXCEPT PROPERLY QUALIFIED SERVICE PERSONNEL.**

**CHANGES OR MODIFICATIONS NOT EXPRESSLY APPROVED BY THE MANUFACTURER FOR COMPLIANCE COULD VOID THE USER'S AUTHORITY TO OPERATE THE EQUIPMENT.**

### INFORMATION FOR USERS:

**CHANGES OR MODIFICATIONS TO THIS PRODUCT NOT APPROVED BY THE MANUFACTURER WILL VOID THE WARRANTY.**

## Handling Compact Discs

Use only compact discs bearing the  or  mark.

Do not play heart-shaped, octagonal, or other specially shaped compact discs.

Some CDs recorded in CD-R/CD-RW mode may not be usable.

### Handling

- Compared to ordinary music CDs, CD-R and CD-RW discs are both easily affected by high temperature and humidity and some of CD-R and CD-RW discs may not be played. Therefore, do not leave them for a long time in the car.
- New discs may have some roughness around the edges. If such discs are used, the player may not work or the sound may skip. Use a ball-point pen or the like to remove any roughness from the edge of the disc.
- Never stick labels on the surface of the compact disc or mark the surface with a pencil or pen.
- Never play a compact disc with any cellophane tape or other glue on it or with peeling off marks. If you try to play such a compact disc, you may not be able to get it back out of the CD player or it may damage the CD player.
- Do not use compact discs that have large scratches, are misshapen, cracked, etc. Use of such discs may cause misoperation or damage.

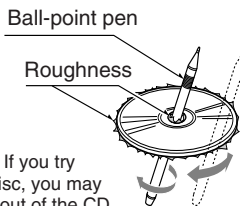

- To remove a compact disc from its storage case, press down on the center of the case and lift the disc out, holding it carefully by the edges.
- Do not use commercially available CD protection sheets or discs equipped with stabilizers, etc. These may damage the disc or cause breakdown of the internal mechanism.

### Storage

- Do not expose compact discs to direct sunlight or any heat source.
- Do not expose compact discs to excess humidity or dust.
- Do not expose compact discs to direct heat from heaters.

### Cleaning

- To remove fingermarks and dust, use a soft cloth and wipe in a straight line from the center of the compact disc to the circumference.
- Do not use any solvents, such as commercially available cleaners, anti-static spray, or thinner to clean compact discs.
- After using special compact disc cleaner, let the compact disc dry off well before playing it.

# 3. DVD VIDEO SYSTEM

DVD video is a high-quality digital video source that provides crisp and clear images. One 12 cm disc contains either one film or four hours of music.

## ● DVD Video Features

This unit provides the following functions in addition to the high image quality and sound quality of DVD video.

### Notes:

- The functions described in the section, "Features", for example, the recorded language, subtitles, angles, etc. differ with the DVD video disc. Refer to the instructions provided with the DVD video.
- Some disc functions may operate differently than described in this manual.

## ● Multi-sound function

DVD video can store up to 18 languages for one film; select the language of your preference.

- The languages stored on the disc are indicated by the icon as shown.



## ● Multi-angle function

A DVD video that is filmed from multiple angles allows you to select the angle of choice.

- The number of recorded angles are indicated by the icon as shown.



## ● Subpicture (subtitles) function

A DVD video can record subtitles for up to 32 languages and you can select the language of the subtitles you wish to see.

- The number of recorded subtitle languages are indicated by the icon as shown.



## ● Multi-story function

When a DVD video contains more than one story for a film, you can select the story you wish to enjoy. The operation procedures vary with the disc; observe the instructions for selecting a story provided during playback.

## ● Dolby Digital

Dolby Digital enables up to 5.1 independent multi-channel audio reproduction, the same type of surround system that is also used in movie theaters.

## ● DTS

DTS (Digital Theater System) is a sound system that differs from the Dolby Digital system. DTS provides a larger amount of data than Dolby Digital enabling high-quality surround playback and incorporates a DTS-CD software for music like a DVD software allows 5.1 channel independent multi-channel audio reproduction.

## ● Menu screens

Menus can be called up during DVD video playback to perform menu setting.

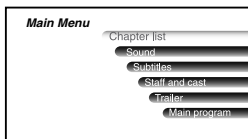

## Discs

### ● Playable discs

This DVD video player can play the following discs.

### Note:

- When you play a CD Extra disc, only the first session will be recognized.

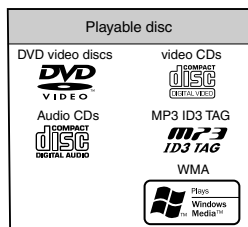

## ● About CD Extra discs

A CD Extra disc is a disc in which a total of two sessions have been recorded. The first session is Audio session and the second session Data session.

Your personally-created CDs with more than second data sessions recorded cannot be played on this DVD video player.

## ● About playing a CD-R/CD-RW, DVD±R/RW disc

This player can play CD-R/CD-RW, DVD±R/RW discs previously recorded in music CD format or video CD format.

## ● Discs that cannot be played back

This DVD video player cannot play back DVD-Audio, DVD-RAM, Photo CDs, etc.

### Notes:

- It may also not be possible to play back CDs recorded on a CD-R unit and CD-RW unit. (Cause: disc characteristics, cracks, dust/dirt, dust/dirt on player's lens, etc.)
- If a CD-R or CD-RW disc that has not been finalized is played, it will take a long time to start playing. Also, it may not be possible to play depending on its recording conditions.
- You cannot play Super Audio CDs. Playback of the CD layer is not supported even if it is a hybrid disc.

## ● Note on region numbers

The DVD video system assigns a region number to DVD video players and DVD discs by sales area.

This player can play "ALL" and "3" or "4" (and those inclusive). For information checking on the recognition of "3" and "4", see page 34 "Country code list". The DVD video region number is marked on the disc jacket as shown.



## ● TV color system

This DVD player plays NTSC discs and PAL discs only and cannot be used for playback of SECAM discs.

## ● About MP3/WMA playback

This unit can play back CD-R/CD-RW discs on which MP3/WMA music data have been recorded. For a detailed information, see the page entitled "Listening to an MP3/WMA".

## About the registered marks etc.

- This product incorporates copyright protection technology that is protected by method claims of certain U.S. patents and other intellectual property rights owned by Macrovision Corporation and other rights owners. Use of this copyright protection technology must be authorized by Macrovision Corporation, and is intended for home and other limited viewing uses only unless otherwise authorized by Macrovision Corporation. Reverse engineering or disassembly is prohibited.
- Manufactured under license from Dolby Laboratories. "Dolby", "Pro Logic", and the double-D symbol are trademarks of Dolby Laboratories.
- Manufactured under license from Digital Theater Systems, Inc. U.S. Pat. No's. 5,451,942; 5,956,674; 5,974,380; 5,978,762; 6,226,616; 6,487,535 and other U.S. and world-wide patents issued and pending. "DTS" and "DTS Digital Surround" are registered trademarks of Digital Theater Systems, Inc. Copyright 1996, 2003 Digital Theater Systems, Inc. All Rights Reserved.

Be sure to unfold and read the next page. /

务必打开并阅读下一页。 /

이 페이지를 펼친 채로 다음 페이지를 읽어 주십시오.

# 4. CONTROLS / 控制键 / 컨트롤

Source unit / 主机 / 본체

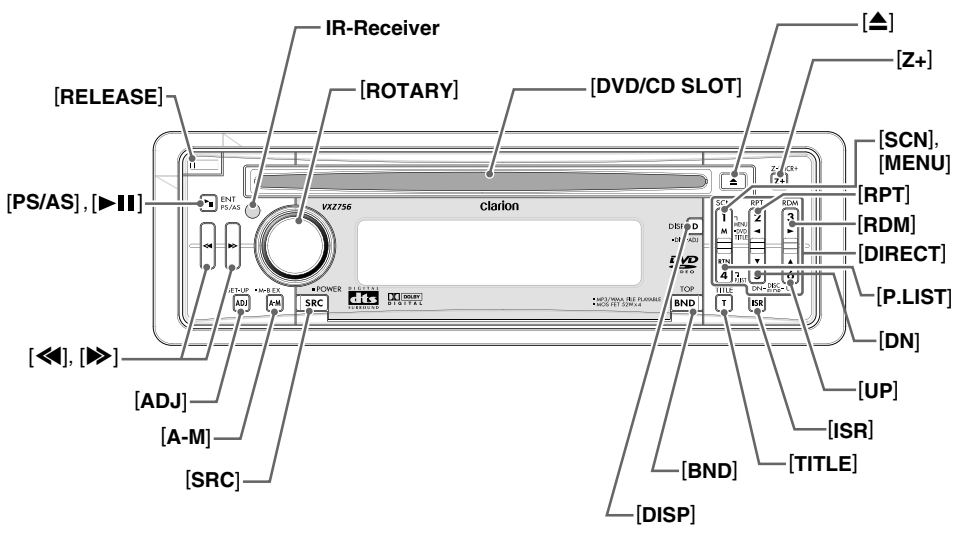

**Note:** Be sure to unfold this page and refer to the front diagrams as you read each chapter.

注: 请务必打开此页, 并在阅读每一章节时参照上面的正视图。

주: 이 페이지를 펼쳐두고, 각 장을 읽을 때 전면 그림을 참조하십시오.

# 5. NOMENCLATURE

## Note:

- Be sure to read this chapter referring to the front diagrams of chapter "4. CONTROLS" on page 5 (unfold).

## Names of the Buttons and their Functions

### [RELEASE] button

- Deeply push in the button to unlock the DCP.

### IR-Receiver

- Receiver for remote control unit. (Operating range: 30° in all directions)

### [ROTARY] knob

- Turn to adjust the volume.
- Performs various settings.

### [DVD/CD SLOT]

- Ejects a disc loaded in the unit.

### [▲] button

- Eject a disc when it is loaded into the unit.

### [Z+] button

- Use the button to select one of the 4 types of sound characteristics already stored in memory. Press and hold for 1 second or longer to return to "FLAT" the default value.

### [SCN], [MENU] button

- Performs scan play for 10 seconds of each track while in the DVD mode.
- Press and hold for 1 second or longer to perform folder scan play while an MP3/WMA disc is playing.
- The DVD menu is displayed while a DVD is playing. Pressing and holding for 1 second or longer also displays the DVD title screen.
- The VCD MENU is displayed while a Video CD is playing (when PBC is ON).

### [RPT] button

- Repeats play while in the DVD mode.
- Press and hold for 1 second or longer to perform folder repeat play while an MP3/WMA disc is playing.
- Press and hold for 1 second or longer to repeat the title while a DVD is playing .

### [RDM] button

- Performs random play while in the DVD mode.
- Press and hold for 1 second or longer to perform folder random play while an MP3/WMA disc is playing.

### [DIRECT] buttons

- Stores a station into memory or recalls it directly while in the radio mode.

### [P.LIST] button

- Press and hold for 1 second or longer to turn on or off the play list mode. (MP3/WMA disc only)

### [UP], [DN] buttons

- Selects the folder while an MP3/WMA disc is playing.
- Selects the play list while in the play list mode.

### [ISR] button (Instant station recall)

- Recalls ISR radio station in memory.
- Press and hold for 2 seconds or longer. Stores current station into ISR memory (radio mode only).

### [TITLE] button

- Switches the titles.
- Press and hold for 1 second or longer to input or scroll the title.

### [BND] button

- Switches the band.
- Press and hold for 1 second or longer to switch seek or manual tuning.
- Returns to a first scene or track while in the DVD mode.

### [DISP] button

- Switches the display indication (main display, clock display).
- Press and hold for 1 second or longer to switch to the display adjust mode.

### [SRC] button

- Press to turn on the power.
- Press and hold for 1second or longer to turn off the power.
- Switches the operation mode among the radio mode, etc.

### [A-M] button

- Switches to the audio mode (CENTER-VOL, SUB-WOOF VOL, BASS, TREBLE, BALANCE, FADER, Z-Enhancer Plus).
- Press and hold for 1 second or longer to turn on or off the MAGNA BASS EXTENDED.

**[ADJ] button**

- Switches to the adjust mode.
- Press and hold for 1 second or longer to display the setup main menu while in the DVD mode.

**[◀◀] / [▶▶] buttons**

- Select a station while in the radio mode or select a scene or a track while in the DVD mode.
- These buttons are used to make various settings.
- Press and hold for 1 second or longer to switch the fast-forward/fast-rewind.

**[PS/AS], [▶||] button**

- Plays or pauses a CD or DVD while in the DVD mode.
- Press and hold for 1 second or longer in the DVD mode to stop playback.
- Performs preset scan in the radio mode.
- Press and hold for 2 seconds or longer to perform auto store in the radio mode.
- Confirms various settings.

## Major Button Operations When External Equipment is Connected to This Unit

### ● When the CD changer is connected

- \* For details, see the section “CD changer Operations”.

**[SCN] button**

- Performs scan play for 10 seconds of each track.
- Press and hold for 1 second or longer to perform disc scan play.

**[RPT] button**

- Performs repeat play.
- Press and hold for 1 second or longer to perform disc repeat play.

**[RDM] button**

- Performs random play.
- Press and hold for 1 second or longer to perform disc random play.

**[UP], [DN] buttons**

- Selects the disc.

**[TITLE] button**

- Switches the titles.
- Press and hold for 1 second or longer to input or scroll the title.

**[BND] button**

- Advances to next disc.

**[DISP] button**

- Switches the display indication (main display, clock display).

**[◀◀] / [▶▶] buttons**

- Repeats or advances a track when listening to a disc.
- Press and hold for 1 second or longer to switch the fast-forward/fast-rewind.

**[▶||] button**

- Plays or pauses a CD.

### ● When the TV is connected

- \* For details, see the section “TV Operations”.

**[DIRECT] buttons**

- Stores a station into memory or recalls it directly.

**[BND] button**

- Switches the band.
- Press and hold for 1 second or longer to switch seek or manual tuning.

**[ADJ] button**

- Press and hold for 1 second or longer to switch the TV picture mode or VTR (external) picture mode.

**[◀◀] / [▶▶] buttons**

- Selects a station.

**[PS/AS] button**

- Performs preset scan in the TV mode.
- Press and hold for 2 seconds or longer to perform auto store in the TV mode.

# Display Items

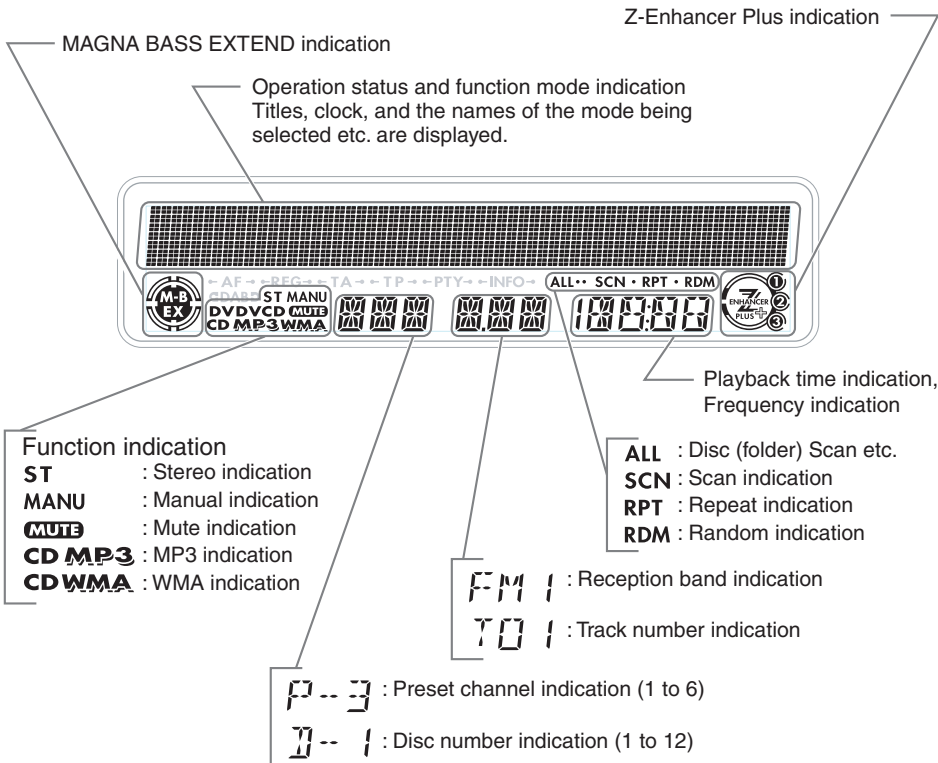

## LCD Screen

In extreme cold, the screen movement may slow down and the screen may darken, but this is normal. The screen will recover when it returns to normal temperature.



# 6. DCP

The control panel can be detached to deter theft. When detaching the control panel, store it in the DCP (DETACHABLE CONTROL PANEL) case to prevent scratches.

We recommend taking the DCP with you when leaving the car.

## Removing the DCP

1. Press the [SRC] button for 1 second or longer to switch off the power.
2. Press the [RELEASE] button deeply to open the DCP.

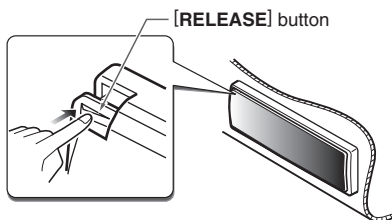

3. Pull the DCP toward you and remove it.

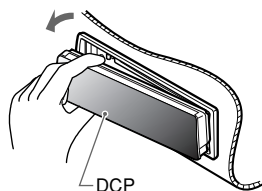

## Attaching the DCP

1. Insert the DCP so that the (A) section on the right side of the DCP catches on the hook (B) on the unit.

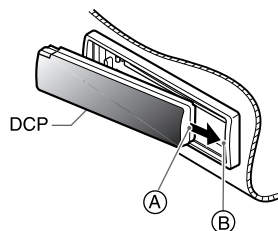

2. Press the left side (C) of the DCP carefully to fit it in place.

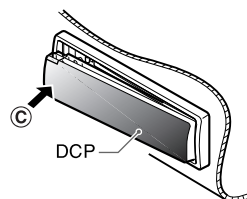

## ⚠ CAUTION

- The DCP can easily be damaged by shocks. After removing it, be careful not to drop it or subject it to strong shocks.
- If the [RELEASE] button is pressed and the DCP is not locked into place, it may fall out from vibration of the car. This can break the DCP, so after removing it, either install it on the unit or put it in its DCP case.
- The connector connecting the unit and the DCP is an extremely important part. Be careful not to damage it by pressing on it with fingernails, screwdrivers, etc.

### Note:

- If the DCP is dirty, wipe off the dirt with a soft, dry cloth only.

# 7. REMOTE CONTROL

## Buttons Used in the DVD Mode

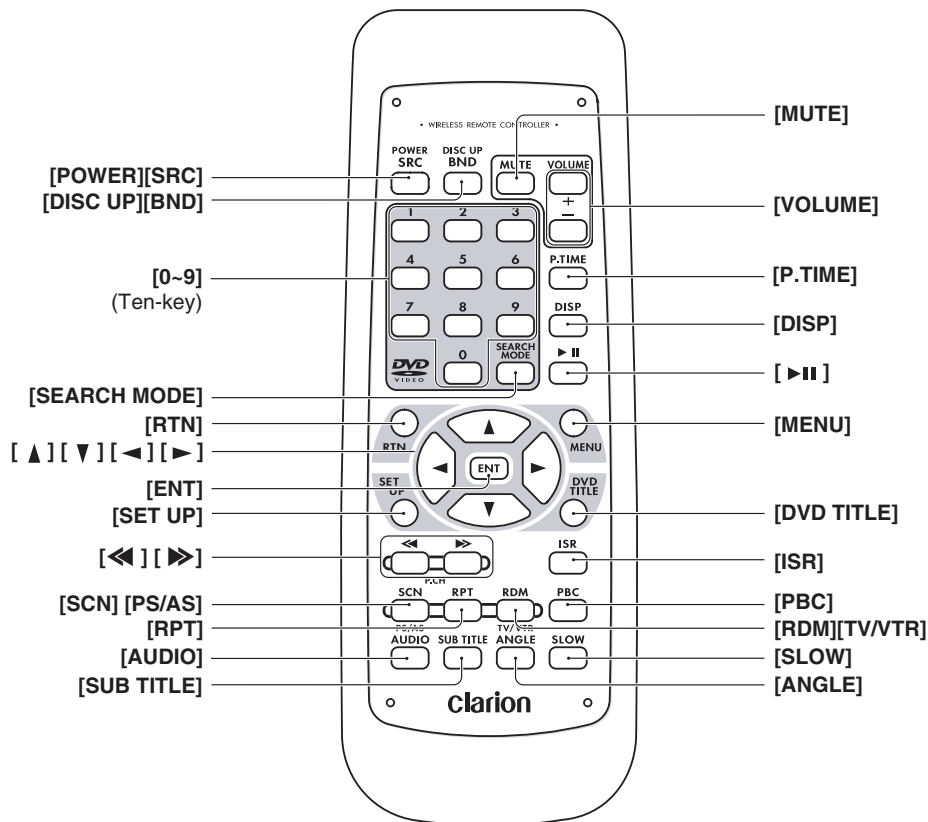

### [P.TIME] button

Used to switch among play time displays

### [0-9] buttons (Ten-key buttons)

Used to input numbers.

### [MENU] button

V-CD (with PBC):Displays the PBC menu.

DVD VIDEO:Displays the menu screen.

### [RTN] button

Returns to the previous menu.

### [◀], [▶], [▲], [▼] buttons (cursor buttons)

When selecting the menu items shown in the monitor screen, use the cursor buttons to move the cursor up and down, left and right.

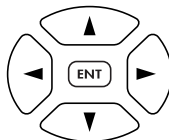

### [ENT] button

Press this button to enter the setup item.

### [DVD TITLE] button

DVD VIDEO:Displays the title screen.

### [SET UP] button

Displays the setup screen of the unit.

**[PBC] button**

Turns on/off the playback control (PBC) function for V-CDs equipped with it.

**[AUDIO] button**

DVD VIDEO: Switches among languages for audio (for DVDs with two or more languages).

V-CD: Switches among audio output methods.

**[SUB TITLE] button**

Switches among languages for the subtitle.

**[ANGLE] button**

Switches among angles while in DVD playback.

(This button is available only on multiple angles DVDs.)

**[SLOW] button**

While the button is kept pressed, slow play is performed.

**[SEARCH MODE] button**

After this button is pressed, enter numbers using Ten-key buttons.

**DVD-VIDEO:** Performs searching with a title/ chapter number.

**MP3/WMA:** FOLDER/TRACK number.

**V-CD** (key inputs are accepted only when the PBC is turned off.):  
TRACK number

**CD:** TRACK number.

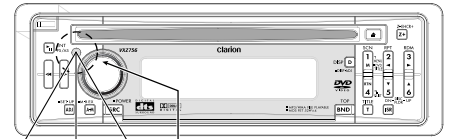

Receiver for remote control unit

Operating range :  
30° in all directions

Signal transmitter

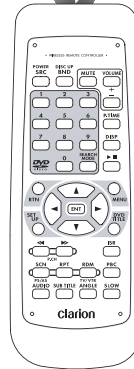

## Inserting the Batteries

1. Open the rear battery cover.

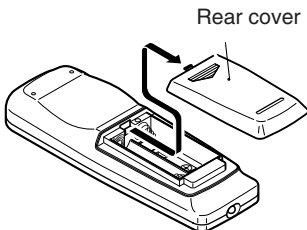

Rear cover

2. Insert the two supplied size AA (SUM-3, R6/ 1.5V) batteries orienting the plus and minus poles of the batteries as shown by the ⊕ and ⊖ symbols inside the battery compartment. Close the battery cover.

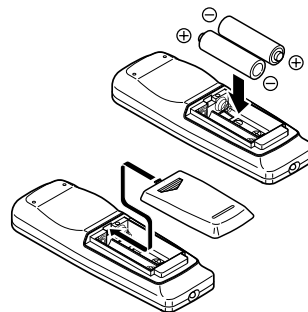
**Notes:**

Using batteries improperly can cause them to explode. Take note of the following points:

- When replacing batteries, replace both batteries with new ones.
- Do not short-circuit, disassemble or heat batteries.
- Do not dispose of batteries into fire or flames.
- Dispose of spent batteries properly.

## Functions of the Remote Control Unit Buttons

Mode Button	Radio	DVD (CD/MP3/WMA)	CD changer	TV
[SRC]	Switches among radio, DVD (CD/MP3/WMA), CD changer, TV and AUX.			
[DISC UP], [BND]	Switches reception band.	Plays the first track. Top play.	Moves the next disc in increasing order.	Switches reception band.
[VOLUME]	Increases and decreases volume (in all modes).			
[◀], [▶]	Moves preset channels up and down.	Moves tracks up and down. When pressed and held for 1 second: Fast-forward/fast-rewind.		Moves preset channels up and down.
[▶▶]	No function.	Switches between playback and pause. When pressed and held for 1 second or longer to stop play.	Switches between playback and pause.	No function.
[MUTE]	Turns mute on and off.			
[ISR]	Recalls ISR radio station in memory. When pressed and held for 2 seconds or longer: Stores current station into ISR memory (radio mode only).			
[DISP]	Switches among main display and clock display. When pressed and held for 1 second or longer: Switches the title (except in the radio and TV mode).			
[SCN], [PS/AS]	Preset scan. When pressed and held for 2 seconds or longer: Auto store.	Scan play. When pressed and held for 1 second or longer: Folder scan play (MP3/WMA disc).	Scan play. When pressed and held for 1 second or longer: Disc scan play.	Preset scan. When pressed and held for 2 seconds or longer: Auto store.
[RPT]	No function.	Repeat play. When pressed and held for 1 second or longer: Folder repeat play (MP3/WMA disc).	Repeat play. When pressed and held for 1 second or longer: Disc repeat play.	No function.
[RDM], [TV/VTR]	No function.	Random play. When pressed and held for 1 second or longer: Folder random play (MP3/WMA disc).	Random play. When pressed and held for 1 second or longer: Disc random play.	Switches between TV and VTR.

\* Some of the corresponding buttons on the source unit and remote control unit have different functions.

# 8. OPERATIONS

## Basic Operations

**Note:** Be sure to read this chapter referring to the front diagrams of chapter "4. CONTROLS" on page 5 (unfold).

### ⚠ CAUTION

Be sure to lower the volume before switching off the unit power or the ignition key. The unit remembers its last volume setting. If you switch the power off with the volume up, when you switch the power back on, the sudden loud volume may hurt your hearing and damage the unit.

### System check and speaker setting

During the initial power up of this unit, it will go through a system check procedure.

This procedure verifies any devices connected through CeNET. Any additional CeNET devices plugged into the unit after the initial power up will initiate the system check procedure.

When the power is turned on, "SYSTEM CHK" appears in the display if the wire connections were modified.

The system check starts automatically within the unit.

When the system check is complete, "SP-SETTING" appears in the display. Perform the speaker setting.

1. Turn the [ROTARY] knob to select the speaker system.
  - \* The factory default setting is "2ch". (Adjustment 2ch/5.1ch)
2. Press the [▶||] button.
  - \* The setting is complete and the power turns off.

### Turning on/off the power

#### Note:

• Be careful about using this unit for a long time without running the engine. If you drain the car's battery too far, you may not be able to start the engine and this can reduce the service life of the battery.

1. Press the [SRC] button.
2. The illumination and display on the unit light up. The unit automatically remembers its last operation mode and will automatically switch to display that mode.
3. Press and hold the [SRC] button for 1 second or longer to turn off the power for the unit.

### Selecting a mode

1. Press the [SRC] button to change the operation source mode.
2. Each time you press the [SRC] button, the operation mode changes in the following order:

Radio mode → DVD mode →  
CD changer mode → TV mode →  
AUX mode → Radio mode...

\* External equipment not connected with CeNET is not displayed.

### Adjusting the volume

Turn the [ROTARY] knob to adjust the volume.

\* The volume level is from 0 (minimum) to 33 (maximum).

### Switching the display

● When the power is turned on  
Each time you press the [DISP] button, the display switches in the following order:

Main display → Clock display →  
Main display ...

\* Once selected, the preferred display becomes the display default. When a function adjustment such as volume is made, the screen will momentarily switch to that function's display, then revert back to the preferred display several seconds after the adjustment.

### Setting the Z-Enhancer Plus

This unit is provided with 4 types of sound tone effects stored in memory. Select the one you prefer.

\* This function cannot be adjusted when as follows:  
"Pro Logic" is set to "ON", the speaker system is set to "5.1ch", DVD/DTS-CD is being played.  
\* The factory default setting is "Z+ OFF".

Each time you press the [Z+] button, the tone effect changes in the following order:

"Z+ OFF" → "BASS BOOST" → "IMPACT" →  
"EXCITE" → "CUSTOM" → "Z+ OFF"...

- BASS BOOST: bass emphasized
- IMPACT: bass and treble emphasized
- EXCITE: bass and treble emphasized, mid de-emphasized
- CUSTOM: user custom
- Z+ OFF: no sound effect

## Adjusting the Z-Enhancer Plus

\* This function cannot be adjusted when as follows: "Pro Logic" is set to "ON", the speaker system is set to "5.1ch", DVD/DTS-CD is being played.

1. Press the [Z+] button and select the Z-Enhancer Plus mode to adjust.
  2. Press the [A-M] button and turn the [ROTARY] knob to adjust the setting.
    - When "B-BOOST 0" selected, you can adjust the bass in the range of -3 to 3.
    - When "IMPACT 0" selected, you can adjust the bass and treble in the range of -3 to 3.
    - When "EXCITE 0" selected, you can adjust the bass and treble in the range of -3 to 3.
- \* When Z-Enhancer Plus is selected, press and hold the [Z+] button for 1 second or longer to change to the "CUSTOM" mode. Bass/treble characteristics become flat and the indication "Z+ FLAT" is shown in the display.

## Adjusting the tone

\* This function cannot be adjusted when as follows: "Pro Logic" is set to "ON", the speaker system is set to "5.1ch", DVD/DTS-CD is being played.

Press the [A-M] button and select the item to adjust. Each time you press the [A-M] button, the item changes as following order:

- When "BASS BOOST" is set  
"CTR-VOL 0" → "SW-VOL 0" → "B-BOOST 0" → "BAL 0" → "FAD 0" → Last function mode.
  - When "IMPACT" is set  
"CTR-VOL 0" → "SW-VOL 0" → "IMPACT 0" → "BAL 0" → "FAD 0" → Last function mode.
  - When "EXCITE" is set  
"CTR-VOL 0" → "SW-VOL 0" → "EXCITE 0" → "BAL 0" → "FAD 0" → Last function mode.
  - When "CUSTOM" is set  
"CTR-VOL 0" → "SW-VOL 0" → "BASS" → "TREBLE" → "BAL 0" → "FAD 0" → Last function mode.
  - When "Z+ OFF" is set  
"CTR-VOL 0" → "SW-VOL 0" → "BAL 0" → "FAD 0" → Last function mode.
- \* "CTR-VOL" does not appear when the speaker system is set to "2ch".
- \* The display automatically returns to the previous mode when no operation is performed.

## Adjusting the center speaker

\* This function cannot be adjusted when as follows: "Pro Logic" is set to "ON", the speaker system is set to "5.1ch", DVD/DTS-CD is being played.

- \* This function cannot be adjusted when the center speaker output is set to "OFF" or the speaker system is set to "2ch". For details on how to set the center speaker, refer to the subsection "Turning on/off speakers" in the section "Changing Initial Settings such as Menu Language, etc.".
  - \* The factory default setting is "CTR-VOL 0".
1. Press the [A-M] button and select "CTR-VOL 0".
  2. Turn the [ROTARY] knob to select from -4 to +8 or OFF.
  3. When the adjustment is complete, press the [A-M] button several times until the function mode is reached.

## Adjusting the subwoofer

\* This function cannot be adjusted when as follows: "Pro Logic" is set to "ON", the speaker system is set to "5.1ch", DVD/DTS-CD is being played.

\* This function cannot be adjusted when the subwoofer output is set to "OFF". For details on how to set the subwoofer, refer to the subsection "Turning on/off speakers" in the section "Changing Initial Settings such as Menu Language, etc.".

- \* The factory default setting is "SW-VOL 0".
1. Press the [A-M] button and select "SW-VOL 0".
  2. Turn the [ROTARY] knob to select from -6 to +6 or OFF.
  3. When the adjustment is complete, press the [A-M] button several times until the function mode is reached.

## Adjusting the bass (Gain, Frequency, Q-curve)

\* This function cannot be adjusted when as follows: "Pro Logic" is set to "ON", the speaker system is set to "5.1ch", DVD/DTS-CD is being played.

- \* This adjustment can only be performed when the Z-Enhancer Plus is set to "CUSTOM".
1. Press the [A-M] button and select "BASS".
  2. Turn the [ROTARY] knob to adjust the bass.
    - \* The factory default setting is "B◀GAIN 0▶". (Adjustment range: -6 to +6)

3. Press the [◀|/▶] button to select "**B◀F 60▶**".  
Turn the [ROTARY] knob to select the frequency.  
\* The factory default setting is "**B◀F 60▶**".  
(Adjustment 60/100/200 Hz)
4. Press the [◀|/▶] button to select "**B◀Q 1▶**".  
Turn the [ROTARY] knob to select the Q-curve.  
\* The factory default setting is "**B◀Q 1▶**".  
(Adjustment 1/1.25/1.5/2)
5. When the adjustment is complete, press the [A-M] button several times until the function mode is reached.

### Adjusting the treble (Gain, Frequency)

- \* This function cannot be adjusted when as follows: "**Pro Logic**" is set to "**ON**", the speaker system is set to "**5.1ch**", DVD/DTS-CD is being played.
  - \* This adjustment can only be performed when the Z-Enhancer Plus is set to "**CUSTOM**".
1. Press the [A-M] button and select "**TREBLE**".
  2. Turn the [ROTARY] knob to adjust the treble.  
\* The factory default setting is "**T◀GAIN 0▶**". (Adjustment range: -6 to +6)
  3. Press the [◀|/▶] button to select "**T◀F 15k▶**".  
Turn the [ROTARY] knob to select the frequency.  
\* The factory default setting is "**T◀F 15k▶**".  
(Adjustment 10 kHz/15 kHz)
  4. When the adjustment is complete, press the [A-M] button several times until the function mode is reached.

### Adjusting the balance

- \* This function cannot be adjusted when as follows: "**Pro Logic**" is set to "**ON**", the speaker system is set to "**5.1ch**", DVD/DTS-CD is being played.
1. Press the [A-M] button and select "**BAL 0**".
  2. Turn the [ROTARY] knob to adjust the balance of the left and right speakers.  
\* The factory default setting is "**BAL 0**".  
(Adjustment range: L13 to R13)
  3. When the adjustment is complete, press the [A-M] button several times until the function mode is reached.

### Adjusting the fader

- \* This function cannot be adjusted when as follows: "**Pro Logic**" is set to "**ON**", the speaker system is set to "**5.1ch**", DVD/DTS-CD is being played.
1. Press the [A-M] button and select "**FAD 0**".
  2. Turn the [ROTARY] knob to adjust the balance of the front and rear speakers.  
\* The factory default setting is "**FAD 0**".  
(Adjustment range: F12 to R12)
  3. When the adjustment is complete, press the [A-M] button several times until the function mode is reached.

### Adjusting MAGNA BASS EXTEND

The MAGNA BASS EXTEND does not adjust the low sound area like the normal sound adjustment function, but emphasizes the deep bass sound area to provide you with a dynamic sound.

- \* This function cannot be adjusted when as follows: "**Pro Logic**" is set to "**ON**", the speaker system is set to "**5.1ch**", DVD/DTS-CD is being played.
  - \* The factory default setting is "**OFF**".
1. Press and hold the [A-M] button for 1 second or longer to turn on the MAGNA BASS EXTEND effect. "**M-B EX**" appears in the display.
  2. Press and hold the [A-M] button for 1 second or longer to turn off the MAGNA BASS EXTEND effect. "**M-B EX**" goes off from the display.

# Radio Operations

## Listening to the radio

1. Press the [SRC] button and select the radio mode. The frequency appears in the display.
2. Press the [BND] button and select the radio band. Each time the button is pressed, the radio reception band changes in the following order:  
**FM1 → FM2 → FM3 → AM → FM1...**
3. Press the [◀]/[▶] button to tune in the desired station.

## Tuning

There are 3 types of tuning modes available, seek, manual and preset tuning.

### Seek tuning

1. Press the [BND] button and select the desired band (FM or AM).
  - \* If "MANU" is lit in the display, press and hold the [BND] button for 1 second or longer. "MANU" in the display goes off and seek tuning is now available.
2. Press the [◀] or [▶] button to automatically seek a station.  
When the [▶] button is pressed, the station is sought in the direction of higher frequencies; if the [◀] button is pressed, the station is sought in the direction of lower frequencies.

### Manual tuning

There are 2 ways available: Quick tuning and step tuning.

When you are in the step tuning mode, the frequency changes one step at a time. In the quick tuning mode, you can quickly tune the desired frequency.

1. Press the [BND] button and select the desired band (FM or AM).
  - \* If "MANU" is not lit in the display, press and hold the [BND] button for 1 second or longer. "MANU" is lit in the display and manual tuning is now available.
2. Tune into a station.

#### ● Quick tuning:

Press the [◀]/[▶] button for 1 second or longer to tune in a station.

#### ● Step tuning:

Press the [◀]/[▶] button to manually tune in a station.

## Recalling a preset station

A total of 24 preset positions (6-FM1, 6-FM2, 6-FM3, 6-AM) exists to store individual radio stations in memory. Pressing the corresponding [DIRECT] button recalls the stored radio frequency automatically.

1. Press the [BND] button and select the desired band (FM or AM).
2. Press the corresponding [DIRECT] button to recall the stored station.
  - \* Press and hold one of the [DIRECT] buttons for 2 seconds or longer to store that station into preset memory.

## Manual memory

1. Select the desired station with seek tuning, manual tuning or preset tuning.
2. Press and hold one of the [DIRECT] buttons for 2 seconds or longer to store the current station into preset memory.

## Auto store

Auto store is a function for storing up to 6 stations that are automatically tuned in sequentially. If 6 receivable stations cannot be received, a previously stored station remains unoverwritten at the memory position.

1. Press the [BND] button and select the desired band (FM or AM).
2. Press and hold the [PS/AS] button for 2 seconds or longer. The stations with good reception are stored automatically to the preset channels.

## Preset scan

Preset scan receives the stations stored in preset memory in order. This function is useful when searching for a desired station in memory.

1. Press the [PS/AS] button.
2. When a desired station is tuned in, press the [PS/AS] button again to continue receiving that station.

#### Note:

- Be careful not to press and hold the [PS/AS] button for 2 seconds or longer, otherwise the auto store function is engaged and the unit starts storing stations.



### Instant station recall (ISR)

Instant station recall is a special radio preset that instantly accesses a favorite radio station at a touch of a button. The ISR function even operates with the unit in other modes.

#### ●ISR memory

1. Select the station that you wish to store in ISR memory.
2. Press and hold the [ISR] button for 2 seconds or longer.

#### ●Recalling a station with ISR

In any mode, press the [ISR] button to turn on the radio function and tune the selected radio station. "ISR" appears in the display. Press the [ISR] button again to return to the previous mode.

### Disc-In-Play function

As long as the ignition key is turned to the ON or ACC position, this function allows you to turn the power to the unit and start playing the disc automatically when the disc is inserted even if the power is not turned on.

### Loading a disc

Insert the disc into the DVD/CD insertion slot with its labeled side facing up, then the disc will start playing.

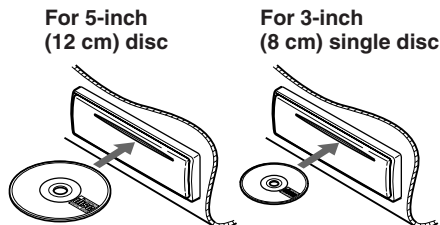

#### Notes:

- Never insert foreign objects into the DVD/CD SLOT.
- If the disc is not inserted easily, there may be another disc in the mechanism or the unit may require service.

### Loading 8 cm compact discs

- \* No adapter is required to play an 8 cm CD.
- \* Insert the 8 cm CD into the center of the insertion slot.

### Backup Eject function

Pressing the [▲] button ejects the disc even if the power to the unit was not turned on.

Press the [▲] button, then the disc will be ejected.

#### Note:

- If the ejected disc is left as it is, it will be reloaded after 15 seconds. However, single CDs will not be reloaded, so make sure to remove them.

## ⚠ CAUTION

- Do not try to put your hand or fingers in the disc insertion slot. Also never insert foreign objects into the slot.
- Do not insert discs where adhesive comes out from cellophane tape or a rental CD label, or discs with marks where cellophane tape or rental CD labels were removed. It may be impossible to extract these discs from the unit and they may cause the unit to break down.

## DVD Operations

### Listening to a disc already loaded in the unit

Press the [SRC] button to select the DVD mode.

When the unit enters the DVD mode, play starts automatically.

If there is no disc loaded, the indication "NO DISC" appears in the display.

## DVD-Video Operations

### Watching a DVD-Video

After inserting a disc, the play mode is automatically engaged.

- Button operation may not be allowed depending on the story of the disc.

#### ■ After the menu screen is displayed

For normal DVD-Video discs, the menu screen appears.

After the menu screen is displayed, select an item in the following operations and play it back.

### Selecting the DVD menu

1. Press the [MENU] button during playback.
  - \* The DVD menus appears.
  - The displayed contents may differ, depending on the DVD software.
  - Example showing menu display.

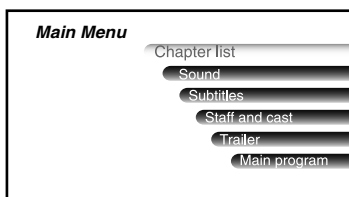

2. Select an item by pressing the [▲] and [▼] buttons and press the [ENT] button to enter. Otherwise, select an item with the ten-key buttons on the remote control unit and press the [ENT] button to enter.
  - \* The video images of the selected item are played back.
  - Depending on the disc, items cannot be selected with the ten-key buttons.

### Stopping playback

Press and hold the [▶||] button for 1 second or longer during playback.

- \* Playback stops.

#### ■ To resume playback

- Press the [▶||] button, and playback resumes from the scene where playback is stopped.

### Pausing playback

Press the [▶||] button during playback.

- \* Playback pauses.

#### ■ To resume playback

- Press the [▶||] button, and playback resumes.

## Slow playback

Press and hold the [SLOW] button on the remote control unit during playback, or press and hold the [▶▶] button during pause.

- \* While the button is being pressed, slow playback continues at the speed 1/2 times the normal playback.
- Slow playback cannot be performed in the backward direction. In addition, audio cannot be reproduced during slow playback.

## Skipping a chapter (searching)

Chapter means a small segment to divide the data area of the disc.

Press the Chapter up [◀◀] button or Chapter down [▶▶] button during playback.

- \* Chapters are skipped, as many as the times the button is pressed, and playback starts.

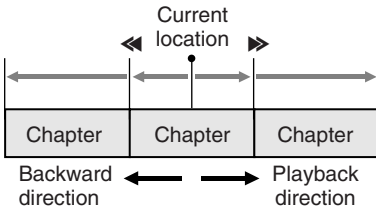

- Press the [▶▶] button, and playback starts from the beginning of the next chapter.
- Press the [◀◀] button, and playback starts from the beginning of the current chapter. When this button is pressed again within about 2 seconds, playback starts from the beginning of the previous chapter.
- The unit may return to the menu screen when the [▶▶] button or [◀◀] button is pressed.

## Fast-forward and fast-rewind

Press and hold the Fast-forward [▶▶▶] button or Fast-rewind [◀◀◀] button during playback.

- \* Press and hold the button, and the playback speed becomes 4-time faster first and then 16-time faster 3 seconds later. Release the button, and the normal speed is restored.
- No audio is reproduced during fast-forward and fast-rewind operation.
- The menu screen may appear when the button is pressed.

## Searching with a chapter/title number

You can locate the beginning of the scene using the chapter numbers or title numbers recorded on the DVD-Video disc.

- \* This function can only be used from the remote control unit.

1. Press the [SEARCH MODE] button during playback and select "[C\*\*]".
  - \* Each time you press the button, you can switch between title number input "[T\*\*]" and chapter number input "[C\*\*]".
  - **Title**  
A large segment to divide the data area of the disc.
  - **Chapter**  
A small segment to divide the data area of the disc.
2. Input the number of the title that you want to play back with the ten-key buttons (0 to 9).
  - To input the title number "12", press "1" of ten-key buttons and then "2".

Press "1".

Press "2".

3. Press the [ENT] button on the remote control unit.
  - \* Playback starts from the scene of the input title number or chapter number.
  - If the input title number does not exist or searching with a title number is not allowed, the following message appears to invalidate the input.

## Repeat playback

This operation plays back chapters/titles recorded on the DVD-Video repeatedly.

Press the **[RPT]** button for chapter repeat.

Press and hold the **[RPT]** button for 1 second or longer for title repeat.

### ● Chapter repeat:

Plays back one chapter repeatedly.

### ● Title repeat:

Plays back all chapters within the title repeatedly.

Press the **[RPT]** button again, and repeat playback is turned off.

## Using the title menu

On DVD discs containing two or more titles, you can select from the title menu for playback.

1. Press the **[DVD TITLE]** button on the remote control unit or press and hold the **[MENU]** button for 1 second or longer on this unit during playback.
  - \* The title menu screen appears.
  - Press the **[MENU]** button to return to the scene before the title menu screen and play the DVD.
  - Depending on the disc, the title menu cannot be called with **[DVD TITLE]** button.
2. Press the **[▲]**, **[▼]**, **[◀]**, **[▶]** buttons or use the ten-key buttons to select an item.
  - Movement of the selected item with the buttons differs depending on the disc. Selection using the ten-key buttons also differs depending on the disc.
  - Depending on the disc, items cannot be selected with the ten-key buttons.
3. Press the **[ENT]** button.

## Switching among languages

On discs in which two or more audios or audio languages have been recorded, you can switch among the audio languages during playback.

\* This function can only be used from the remote control unit.

Press the **[AUDIO]** button during playback.

- \* Each time you press the button, you can switch among audio languages.
- Depending on the disc, up to 8 audios may be recorded. For details, see the mark of the disc (**(8)**): Indicates that 8 audios have been recorded).
- When the power is turned on or when the disc is changed with a new one, the language set at the time of factory shipment is selected. If that language has not been recorded, the language specified on the disc is selected.
- Depending on the disc, switching may be completely impossible or impossible on some scenes.
- It may take time to switch among audios.

## Switching subtitles

On DVD discs in which two or more subtitle languages have been recorded, you can switch among the subtitle languages during playback.

\* This function can only be used from the remote control unit.

Press the **[SUB TITLE]** button during playback.

- \* Each time you press the button, you can switch among subtitles.
- Depending on the disc, up to 32 kinds of subtitles may be recorded. For details, see the mark of the disc (**[.8.]**): Indicates that 8 kinds of subtitles have been recorded).
- Depending on the disc, switching may be completely impossible or impossible on some scenes.
- It may take time to switch among subtitles.

### ● To turn off subtitles

Press the **[SUB TITLE]** button several times, and subtitles are turned off.

In initial setting:

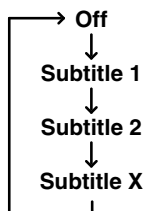

## Switching angles

On DVD discs in which video images have been recorded in two or more angles, you can switch among the angles during playback.

\* This function can only be used from the remote control unit.

Press the **[ANGLE]** button during playback.

- \* Each time you press the button, you can switch among angles.
- Depending on the disc, up to 9 angles may be recorded. For details, see the mark of the disc (Ⓜ<sub>8</sub>1): Indicates multi-angle).
- Depending on the disc, angles may switch smoothly or switch with a momentary still image.
- Depending on the disc, switching may be completely impossible or impossible on some scenes.
- It may take time to switch among angles.
- Depending on the disc, scenes recorded in two or more angles may be played back.

## Displaying the playback status

\* This function can only be used from the remote control unit.

Press the **[P.TIME]** button during playback.

\* Each time you press the button, you can switch between display (ON) and non-display (OFF) of the playback status.

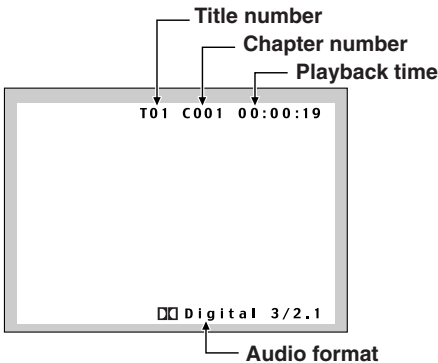

By pressing the button for 1 second or longer while the playback status is displayed, you can switch among time displays.

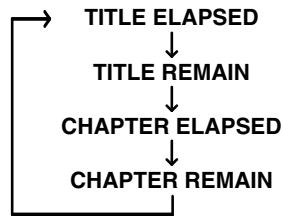
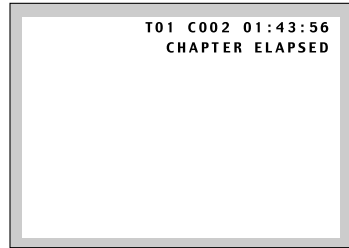

- **TITLE ELAPSED:**  
Elapsed time of the title
- **TITLE REMAIN:**  
Remaining time of the title
- **CHAPTER ELAPSED:**  
Elapsed time of the chapter
- **CHAPTER REMAIN:**  
Remaining time of the chapter
- **Digital 3/2.1 (Example):**  
Displaying the currently audio format

## Watching a video CD (V-CD)

After inserting a disc, the play mode is automatically engaged.

- Button operation may not be allowed depending on the story of the disc.

### ■ After the menu screen is displayed

For V-CD discs equipped with the PBC (Play Back Control) function, the menu screen appears. After the menu screen is displayed, select an item in the following operations and play it back.

## Selecting the V-CD menu (for V-CD discs with PBC)

This key does not function on some discs.

1. Press the [MENU] button during playback.
  - \* The V-CD menu appears.

The displayed contents may differ, depending on the V-CD software.

  - Example showing menu display.

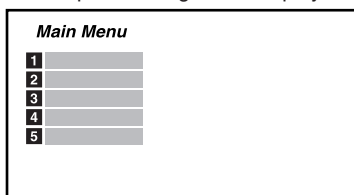

The menu screen can be switched depending on a disc being played.

2. Select an item with the ten-key buttons on the remote control unit and press the [ENT] button to enter.
  - \* The video images of the selected item are played back.

## Stopping playback

Press and hold the [▶|||] button for 1 second or longer during playback.

- \* Playback stops.

### ■ To resume playback

#### When the PBC is turned on

- When the [▶|||] button is pressed, the disc plays from the beginning.  
If the unit is CeNET connected and the function is switched, the disc plays from the beginning.

#### When the PBC is turned off

- Press the [▶|||] button, and playback resumes from the scene where playback is stopped.

## Pausing playback

Press the [▶|||] button during playback.

- \* Playback pauses.

### ■ To resume playback

- Press the [▶|||] button, and playback resumes.

## Slow playback

Press and hold the [SLOW] button on the remote control unit during playback, or press and hold the [▶▶] button during pause.

- \* While the button is being pressed, slow playback continues at the speed 1/2 times the normal playback.
- Slow playback cannot be performed in the backward direction. In addition, audio cannot be reproduced during slow playback.

## Skipping a track (searching)

Press the TRACK up [▶▶] / TRACK down [◀◀] button during playback.

- \* The track is skipped and playback starts.

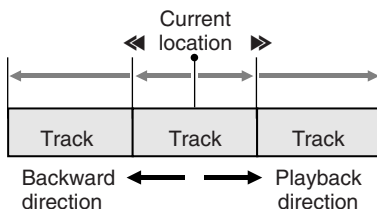

- Press the [▶▶] button, and playback starts from the beginning of the next track.
- Press the [◀◀] button, and playback starts from the beginning of the current track. When this button is pressed again within about 2 seconds, playback starts from the beginning of the previous track.

This operation cannot be performed on some discs with PBC.

### Fast-forward and fast-rewind

Press and hold the Fast-forward [▶▶] button or Fast-rewind [◀◀] button during playback.

- \* Press and hold the button, and the playback speed becomes 4-time faster first and then 16-time faster 3 seconds later. Release the button, and the normal speed is restored.
- No audio is reproduced during fast-forward and fast-rewind operation.
- The unit may return to the menu screen when the button is pressed.

### Searching with a track number

This operation allows searching with the track numbers recorded on the video CDs.

\* This function can only be used from the remote control unit.

1. Press the [SEARCH MODE] button during playback.
2. Input the number of the track that you want to play back with the ten-key buttons (0 to 9).
  - To input the track number "12", press "1" of the ten-key buttons and then "2".

Press "1". T \* \*

Press "2". T 0 1

T 1 2

3. Press the [ENT] button on the remote control unit.
  - \* Playback starts from the scene of the input track number.
  - If the input track number does not exist or searching with a track number is not allowed, the following message appears to invalidate the input.

⊘ INVALID

You cannot do this operation when PBC is ON for a disc with PBC functions.

### Changing audio output

You can change the audio output method.

- \* This function can only be used from the remote control unit.
- Press the [AUDIO] button during playback.
- \* Each time you press the button, you can switch among audio output methods.

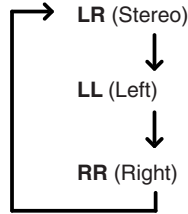

### Scan playback

This operation scans and plays back all tracks on the disc, the first 10 seconds for each.

Press the [SCN] button.

- \* Press the [SCN] button again, and scan playback is turned off.

You cannot do this operation when PBC is ON for a disc with PBC functions.

### Repeat playback

This operation plays back one track recorded on the video CD repeatedly.

Press the [RPT] button.

- \* Press the [RPT] button again, and repeat playback is turned off.

You cannot do this operation when PBC is ON for a disc with PBC functions.

### Random playback

This operation plays back all tracks on the disc in no particular order.

Press the [RDM] button.

- \* Press the [RDM] button again, and random playback is turned off.

You cannot do this operation when PBC is ON for a disc with PBC functions.

## Watching a video CD (V-CD)

### Displaying the playback status

\* This function can only be used from the remote control unit.

Press the [**P.TIME**] button during playback.

- \* Each time you press the button, you can switch between display (ON) and non-display (OFF) of the playback status.

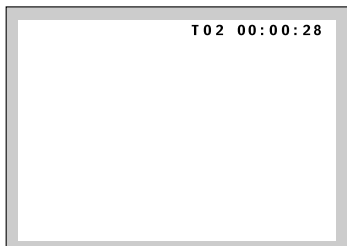

- Even when display of the playback status is OFF, you can display the playback status by operating the button.
- Depending on the playback status or disc, the following indication may appear.

By pressing the button for 1 second or longer, you can switch among time displays.

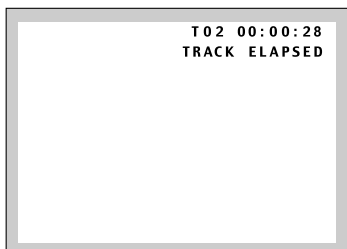

\* Displayed when the PBC is "OFF".

#### Note:

- Depending on some discs, the [**P.TIME**] indication may not be displayed on some scenes. Also, it may occur that the **P.TIME** operation does not work. When this happens, the indication "INVALID" will appear.

### On/off of Play Back Control

On video CDs equipped with Play Back Control function, you can turn it on/off.

\* This function can only be used from the remote control unit.

Press the [**PBC**] button.

- \* Each time you press the button, you can switch between on and off.
- \* When the PBC is turned on or off, the disc plays from the beginning.
- \* The factory default setting of PBC is "ON".

### Playback control (PBC)

This control signal is recorded on a Video CD for version 2.0 and used to control playback. Using pre-recorded menu screens in the Video CD with PBC, you can enjoy playback of software with a simplified dialog function or software with search function. You can also enjoy a still picture at high or standard resolution.

#### When the PBC is turned on

The beginning of a disc is played each time the PBC is turned on or off.



## Listening to a CD

\* This unit is a CD TEXT compatible model.

This unit supports the display of the DISC TITLE, TRACK TITLE and ARTIST of the CD TEXT.

After inserting a disc, the play mode is automatically engaged.

- Example showing CD TEXT display.

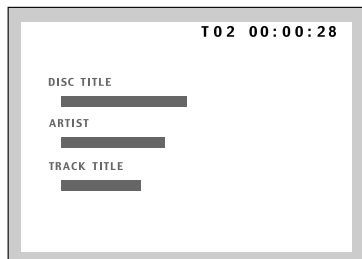

### Note:

- This unit supports only CD TEXT in alphanumerics. Also, some character data may not be reproduced properly on the monitor.

## Top function

The top function resets the CD player to the first track of the disc. Press the [BND] button to play the first track (track No. 1) on the disc.

## Pausing playback

Press the [▶||] button during playback.

- \* Playback pauses.

### ■ To resume playback

- Press the [▶||] button again, and playback resumes.

## Displaying CD titles

This unit can display title data for CD-text disc and user titles input with this unit.

Each time you press the [TITLE] button, the title changes in the following order:

User title (disc) → CD-text title (disc) → Artist name → CD-text title (track) → User title (disc)...

### Note:

- If the CD playing is not a CD-text CD or no user title=(as been input, "NO TITLE" appears in the display.

## Skipping a track (searching)

Press the TRACK up [▶▶]/ TRACK down [◀◀] buttons.

- \* Tracks are skipped, as many as the times the button is pressed, and playback starts.
- Press the [▶▶] button, and playback starts from the beginning of the next track.
- Press the [◀◀] button, and playback starts from the beginning of the current track. When this button is pressed again within about 2 seconds, playback starts from the beginning of the previous track.

## Fast-forward and fast-rewind

Press and hold the Fast-forward [▶▶] button or Fast-rewind [◀◀] button during playback.

- \* Press and hold the button, and the playback speed becomes 4-time faster first and then 8-time faster 3 seconds later. Release the button, and the normal speed is restored.

## Searching with a track number

This operation allows searching using the track numbers recorded on the CDs.

- \* This function can only be used from the remote control unit.

1. Press the [SEARCH MODE] button during playback.
2. Input the number of the track that you want to play back with the ten-key buttons (0 to 9).
  - To input the track number "12", press "1" of the ten-key buttons and then "2".

Press "1".

Press "2".

3. Press the [ENT] button on the remote control unit.

- \* Playback starts from the track of the input track number.
- If the input track number does not exist or searching with a track number is not allowed, the following message appears to invalidate the input.

## Listening to a CD

### Scan playback

This operation scans and plays back all tracks recorded on the disc, the first 10 seconds for each.

Press the [SCN] button.

- \* Press the [SCN] button again, and scan playback is turned off.

### Repeat playback

This operation plays back tracks recorded on the CD repeatedly.

Press the [RPT] button.

- \* Press the [RPT] button again, and repeat playback is turned off.

### Random playback

This operation plays back all tracks on the disc in no particular order.

- \* Searching track down is invalid during random playback.

Press the [RDM] button.

- \* Press the [RDM] button again, and random playback is turned off.

### Changing the display of the playback status

- \* This function can only be used from the remote control unit.

By pressing the [P.TIME] button for 1 second or longer, you can switch among time displays.

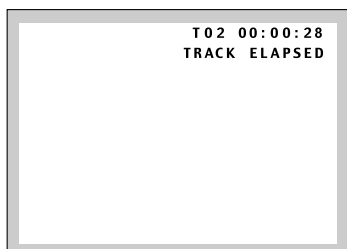

## Listening to an MP3/WMA

### MP3/WMA

#### What is MP3?

MP3 is an audio compression method and classified into audio layer 3 of MPEG standards. This audio compression method has penetrated into PC users and become a standard format.

This MP3 features the original audio data compression to about 10 percent of its initial size with a high sound quality. This means about 10 music CDs can be recorded on a CD-R disc or CD-RW disc to allow a long listening time without having to change CDs.

#### What is WMA?

WMA is the abbreviation of Windows Media Audio, an audio file format developed by Microsoft Corporation.

##### Notes:

- This unit does not support a WMA file protected by DRM (Digital Rights Management). Only files with DRM turned OFF are played.
- Windows Media™, and the Windows ® logo are trademarks, or registered trademarks of Microsoft Corporation in the United States and/or other countries.

##### ● To disable DRM (Digital Rights Management):

1. When using Windows Media Player 8, click on TOOLS → OPTIONS → COPY MUSIC tab, then under COPY SETTINGS, unclick the check box for PROTECT CONTENT. Then, reconstruct files.
2. When using Windows Media Player 9, click on TOOLS → OPTIONS → MUSIC RECORD tab, then under Recording settings, unclick the Check box for RECORD PROTECTED MUSIC. Then, reconstruct files.

Personally constructed WMA files are used at your own responsibility.

#### Precautions when creating MP3/WMA disc

##### ● Usable sampling rates and bit rates:

1. MP3: Sampling rate 32 kHz-48 kHz,  
Bit rate: 8 kbps-320 kbps / VBR
2. WMA: Bit rate 32 kbps-192 kbps

### ● File extensions

1. Always add a file extension “.MP3” or “.WMA” to MP3 or WMA file by using single byte letters. If you add a file extension other than specified or forget to add the file extension, the file cannot be played.
2. Files without MP3/WMA data will be skipped and cannot be played.

### ● Logical format (File system)

1. When writing MP3/WMA file on a CD-R disc or CD-RW disc, please select “ISO9660 level 1, 2 or JOLIET or Romeo” as the writing software format. Normal play may not be possible if the disc is recorded on another format.
2. The folder name and file name can be displayed as the title during MP3/WMA play but the title must be within 62 single byte ASCII characters (including an extension).
3. Do not affix a name to a file inside a folder having the same name.

### ● Folder structure

1. A disc with a folder having more than 8 hierarchical levels will be impossible.

### ● Number of files or folders

1. Up to 999 files/255 folders can be played. But if there are 999 files in one folder, other folders cannot be played.
2. Tracks are played in the order that they were recorded onto a disc. (Tracks might not always be played in the order displayed on the PC.)
3. Some noise may occur depending on the type of encoder software used while recording.
4. In case of a track recorded at VBR (variable bit rate), the display for the play time of the track may be slightly different from the actual play time.  
Also, the recommended value of VBR ranges from 64 kbps to 320 kbps.
5. Depending on the damage conditions of a file, it may occur that the file is not played and the next file is played instead.  
Also, if the damage is in a severe condition, play stops showing the “DISC ERROR” display.

After disc selection, the play mode is automatically engaged.

- Example showing WMA/ID3 Tag display.

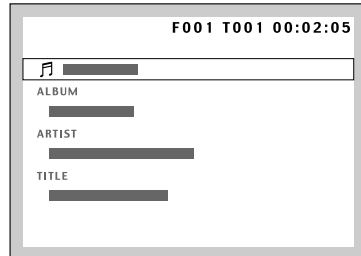

### Note:

- This unit supports only WMA/ID3 Tag information in ASCII characters. Also, some character data may not be reproduced properly on the monitor.

## Top function

The top function resets the MP3/WMA player to the first track of a folder being played. Press the [BND] button to play the first track (track No. 1) of a folder.

## Pausing playback

Press the [▶||] button during playback.

- \* Playback pauses.

### ■ To resume playback

- Press the [▶||] button again, and playback resumes.

## Listening to an MP3/WMA

### Displaying MP3/WMA titles

This unit can display title data for MP3/WMA disc.

Each time you press the [TITLE] button, the title changes in the following order:

**Folder → TRACK → Album TAG → Artist TAG → Title TAG → Folder...**

#### Notes:

- If MP3/WMA disc is not input TAG, "NO TAG" appears in the display.
- For MP3, supports ID3 Tags V2.4 / 2.3 / 2.2 / 1.1 / 1.0.
- Tag displays give priority to V2.4 / 2.3 / 2.2.
- In the case of album Tags for WMA, the information written into the extension header is displayed.
- Only ASCII characters can be displayed in Tags.

### Skipping a track (searching)

Press the TRACK up [▶▶] / TRACK down [◀◀] buttons.

- \* Tracks are skipped, as many as the times the button is pressed, and playback starts.
  - Press the [▶▶] button, and playback starts from the beginning of the next track.
  - Press the [◀◀] button, and playback starts from the beginning of the current track.
- When this button is pressed again within about 2 seconds, playback starts from the beginning of the previous track.

This operation skips the track over the folder.

### Folder select

This function allows you to select a folder containing MP3/WMA files and start playing from the first track in the folder.

- \* This function can only be used from the source unit.

Press the [DN] button to move to the previous folder.

Press the [UP] button to move to the next folder.

- \* Press the [UP] button while in the final folder to shift to the first folder.
- \* Folder without an MP3/WMA file is not selectable.

### Fast-forward and fast-rewind

Press and hold the Fast-forward [▶▶▶] button or Fast-rewind [◀◀◀] button during playback.

- \* Press the button, and the playback speed becomes 4-time faster first and then 8-time faster 3 seconds later. Release the button, and the normal speed is restored.

#### Note:

- Fast-rewind cannot be performed while WMA files are being played.

### Selecting a track on the screen

- \* This function can only be used from the remote control unit.

Select a desired file with the Cursor button ("▲" and "▼") and press the [ENT] button.

- \* Play starts.
- Example showing FOLDER list display.

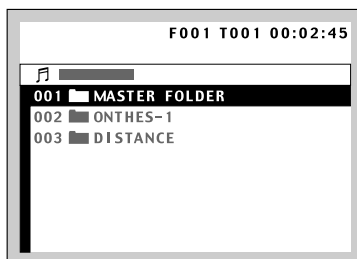

### Screen selection flow

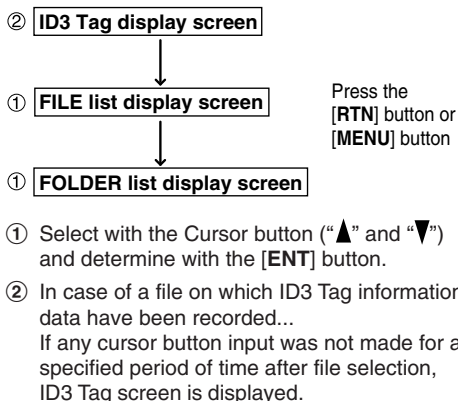

## **Playback by selecting a folder and track (Direct select mode)**

This operation allows searching using the folder and track numbers recorded on the MP3/WMA disc.

\* This function can only be used from the remote control unit.

1. Press the [SEARCH MODE] button during playback.
  - \* Each time you press the button, you can switch between "T000" for track number input and "F000" for folder number input.
2. Input the number for the track or folder that you want to play back with the ten-key buttons (0 to 9).
3. Press the [ENT] button on the remote control unit.

When you select the folder number playback starts from Track 1 of the input folder number.

When you are searching for some other folder and track while a file is being played, pressing the [MENU] button will return to the file being played.

## **Searching a desired track (Track scan playback)**

This operation plays back all tracks recorded on the disc, about 10 seconds for each.

Press the [SCN] button.

\* Scan playback starts from the next track.

### **■ To cancel track scan playback**

Press the [SCN] button again.

## **Searching for a desired folder (Folder scan playback)**

This operation plays back the first tracks of all folders on the MP3/WMA disc, about 10 seconds for each.

Press and hold the [SCN] button for 1 second or longer.

\* Scan playback starts from the first track of the next folder to the one currently being played back.

### **■ To cancel folder scan playback**

Press the [SCN] button again.

## **Listening to one track repeatedly (Track repeat playback)**

This operation plays back the track currently being played back repeatedly.

Press the [RPT] button.

### **■ To cancel track repeat playback**

Press the [RPT] button again.

## **Listening to tracks in a folder repeatedly (Folder repeat playback)**

This operation plays back tracks in an MP3/WMA folder repeatedly.

Press and hold the [RPT] button for 1 second or longer.

### **■ To cancel folder repeat playback**

Press the [RPT] button again.

## **Listening to tracks in a random order (Track random playback)**

This operation plays the tracks in the folder in a random order.

Press the [RDM] button.

\* Searching track down is invalid during random playback.

### **■ To cancel track random playback**

Press the [RDM] button again.

## **Listening to tracks in a random order (Folder random playback)**

This operation plays back tracks recorded on the disc in no particular order.

Press and hold the [RDM] button for 1 second or longer.

### **■ To cancel folder random playback**

Press the [RDM] button again.

## Listening to an MP3/WMA

### Play list mode

This function allows you to play tracks, up to latest 5 time stamps, by reading the play list information written on the disc.

\* This function can only be used from the source unit.

1. Press and hold the [P.LIST] button for 1 second or longer to turn on or off the play list mode.
  - \* Play list play is possible only when there is a file whose extension is “.M3U” on the CD-R/RW.
  - \* Up to 5 play lists can be recognized, and up to 255 files can be recognized per play list.
2. Press the [DN] button to move to the previous play list.  
Press the [UP] button to move to the next play list.

#### Notes:

- The SCN/RPT/RDM functions cannot be used while in the play list mode.
- The title changes from folder name to play list name.

### Making a play list

1. Write desired tracks to a CD-R/RW, etc. Be sure to use ASCII characters for all file names.
2. Make a play list by using a multimedia player, etc. and save the data. The file format must be M3U.
3. Again, write this play list to the CD-R/RW, etc.

#### Notes:

- When writing to a CD-R/RW, etc., be sure to use ASCII characters.
- Up to 5 layers can be recognized as a list. For written play lists, latest 5 lists are recognized in the order in which they are written.
- When writing to a CD-R/RW, etc., turn off the Disc At Once function.
- When adding a play list, it is recommended to write it in the “Root” folder.

### Changing the display of the playback status

\* This function can only be used from the remote control unit.

By pressing the [P.TIME] button for 1 second or longer, you can switch among time displays.

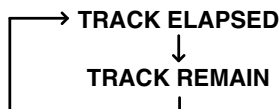
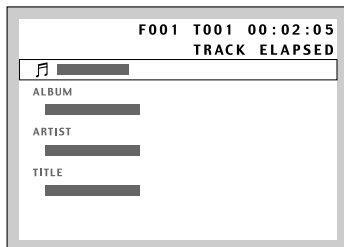

## Selecting the monitor menu

### Notes:

- The setup main menu appears only while in the DVD mode.
- **"PREFERENCES"** appears only when there is no disc loaded and playback stops.
- **"AUDIO SETUP"** appears only when the speaker system is set to **"5.1ch"**.
- Menu settings described in this section are displayed on the monitor.

If the set language has not been recorded on the disc, the language specified on the disc is used for display.

1. Press the **[SET UP]** button on the remote control unit or press and hold the **[ADJ]** button on the unit for 1 second or longer in the DVD mode to display the main menu.
2. Select **"GENERAL SETUP"**, **"PREFERENCES"**, or **"AUDIO SETUP"** with the **"▲"** or **"▼"** button and press the **[ENT]** to enter.
3. Press the **"▲"** or **"▼"** button to select the left menu item.
4. Press the **"▶"** button to go to the option list.
5. Press the **"◀"** button to go to back to the left menu item.
6. Press the **[RTN]** button to display the main menu.
7. Press the **[SET UP]** button on the remote control unit or press the **[ADJ]** button on the unit to return to the original mode from the setup mode engaged.

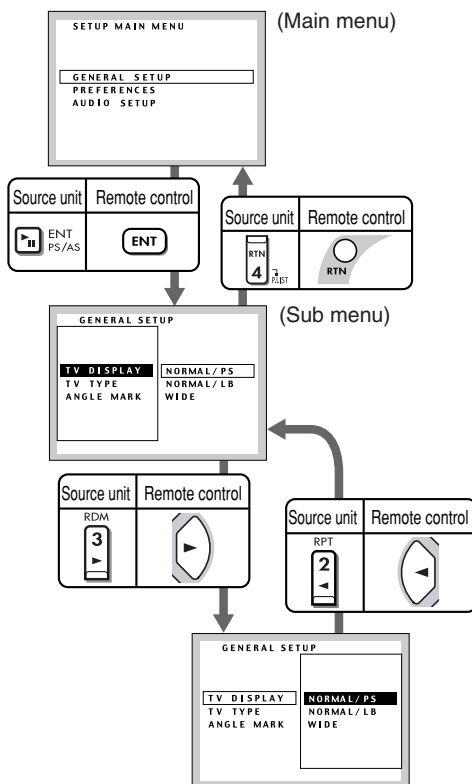

## Changing Initial Settings such as Menu Language, etc.

### Setting up the screen size

Set up the screen size according to the TV monitor to which the unit is connected.

\* The factory default setting is "NORMAL/PS".

- Following the steps 1 to 3 in "Selecting the monitor menu", select "TV DISPLAY" from "GENERAL SETUP", and press the "▶" button to go to the option list.

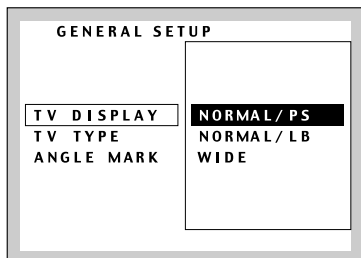

- Press the "▲" or "▼" button to select a screen size.
  - The color of the selected item changes.

#### ● When watching through a conventional TV monitor (4:3)

- NORMAL/PS** : The leftmost and rightmost areas of the screen are cut off.

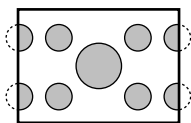

This function allows displaying the important part of image fully on the screen. In some cases, image is displayed while being panned (scrolled).

- NORMAL/LB** : A black zone is created in the top and bottom areas of the screen.

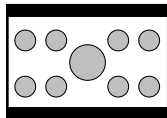

This method displays Cinema Scope and Vista Vision images without cutting them off by creating a black zone on the top and bottom gaps.

- When watching through a wide TV monitor (16:9)
  - **WIDE**:

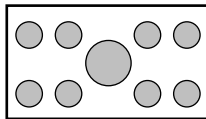

- Press the [ENT] button to enter.

### Setting up the TV type

Set the TV type to NTSC, PAL, MULTI.

\* The factory default setting is "PAL" or "MULTI".

- Following the steps 1 to 3 in "Selecting the monitor menu", select "TV TYPE" from "GENERAL SETUP", and press the "▶" button to go to the option list.

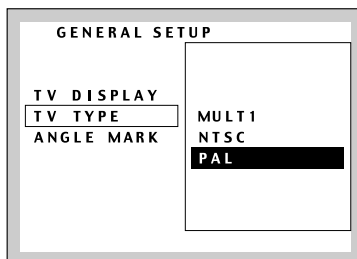

- Press the "▲" or "▼" button to select "MULTI", "NTSC" or "PAL".
- Press the [ENT] button.
  - This setting can also be changed in the Adjust Mode. Refer to the subsection "Setting up the TV type" in the section "TV Operations" for details.

### Setting up the angle mark display

You can set up so that the angle mark appears on scenes where the angles can be switched.

\* The factory default setting is "ON".

- Following the steps 1 to 3 in "Selecting the monitor menu", select "ANGLE MARK" from "GENERAL SETUP", and press the "▶" button to go to the option list.



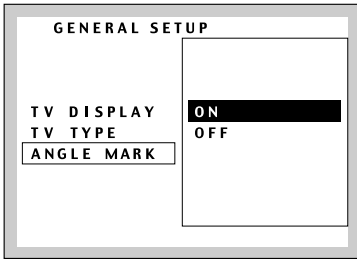

2. Press the “▲” or “▼” button to select “ON” or “OFF”.
3. Press the [ENT] button.

### Setting up the audio language

\* The factory default setting is “ENGLISH”.

1. Following the steps 1 to 3 in “Selecting the monitor menu”, select “AUDIO” from “PREFERENCES”, and press the “▶” button to go to the option list.

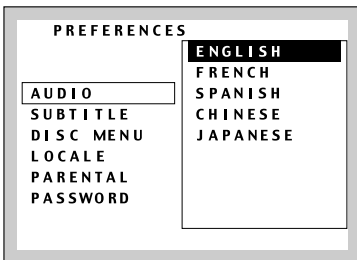

2. Press the “▲” or “▼” button to select a language to be used.

Languages SELECT in the order:

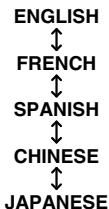

3. Press the [ENT] button.

### Setting up the subtitle language

\* The factory default setting is “OFF”.

1. Following the steps 1 to 3 in “Selecting the monitor menu”, select “SUBTITLE” from “PREFERENCES”, and press the “▶” button to go to the option list.

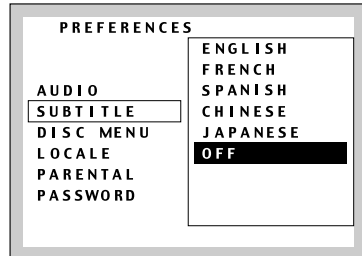

2. Press the “▲” or “▼” button to select a language to be used.

Languages SELECT in the order:



3. Press the [ENT] button.

### Setting up the disc menu language

\* The factory default setting is “ENGLISH”.

1. Following the steps 1 to 3 in “Selecting the monitor menu”, select “DISC MENU” from “PREFERENCES”, and press the “▶” button to go to the option list.

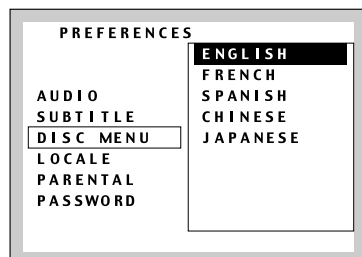

## Changing Initial Settings such as Menu Language, etc.

- Press the “▲” or “▼” button to select a language to be used.

Languages SELECT in the order:

ENGLISH  
↕  
FRENCH  
↕  
SPANISH  
↕  
CHINESE  
↕  
JAPANESE

- Press the [ENT] button.

### Setting up the country code

Set up the country number for setting up of the parental level.

\* The default setting is “8583” (US).

- Following the steps 1 to 3 in “Selecting the monitor menu”, select “LOCALE” from “PREFERENCES”, and press the “▶” button to go to the option list.

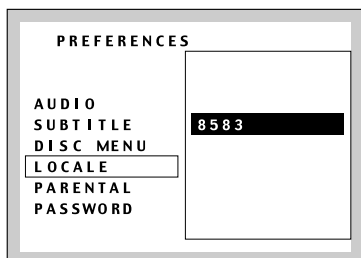

- Press the [ENT] button to display the input screen.
- Press the ten-key buttons to input a 4-digit country number.
- Press the [ENT] button.

### Country code list

Country	Input code
<b>Region number 3</b>	
BRUNEI DARUSSALAM	6678
Kingdom of Cambodia	7572
INDONESIA	7368
KOREA, DEMOCRATIC PEOPLE'S REPUBLIC OF	7580
KOREA, REPUBLIC OF	7582
LAO PEOPLE'S DEMOCRATIC REPUBLIC	7665
MALAYSIA	7789
MYANMAR	7777
PHILIPPINES	8072
SINGAPORE	8371
THAILAND	8472
VIET NAM	8678
EAST TIMOR	8480
HONG KONG	7275
MACAU	7779
TAIWAN, PROVINCE OF CHINA	8487
<b>Region number 4</b>	
ANTIGUA AND BARBUDA	6571
ARGENTINA	6582
AUSTRALIA	6585
BAHAMAS	6683
BARBADOS	6666
BELIZE	6690
BOLIVIA	6679
BRAZIL	6682
CHILE	6776
COLOMBIA	6779
COSTA RICA	6782
CUBA	6785
DOMINICA	6877
DOMINICAN REPUBLIC	6879
ECUADOR	6967
EL SALVADOR	8386
FIJI	7074
GRENADA	7168
GUATEMALA	7184
GUYANA	7189
HAITI	7284
HONDURAS	7278
JAMAICA	7477
KIRIBATI	7573
MARSHALL ISLANDS	7772
MEXICO	7788

Country	Input code
MICRONESIA, FEDERATED STATES OF	7077
NAURU	7882
NEW ZEALAND	7890
NICARAGUA	7873
PALAU	8087
PANAMA	8065
PAPUA NEW GUINEA	8071
PARAGUAY	8089
PERU	8069
SAINT KITTS AND NEVIS	7578
SAINT LUCIA	7667
SAINT VINCENT AND THE GRENADINES	8667
SAMOA	8783
SOLOMON ISLANDS	8366
SURINAME	8382
TONGA	8479
TRINIDAD AND TOBAGO	8484
TUVALU	8486
URUGUAY	8589
VANUATU	8689
VENEZUELA	8669
ANGUILLA	6573
ARUBA	6587
VIRGIN ISLANDS (BRITISH)	8671
CAYMAN ISLAND	7589
CHRISTMAS ISLAND	6789
COCOS (KEELING) ISLANDS	6767
COOK ISLANDS	6775
FALKLAND ISLANDS (MALVINAS)	7075
FRENCH GUIANA	7170
FRENCH POLYNESIA	8070
GUADELOUPE	7180
GUAM	7185
MARTINIQUE	7781
MONTSERRAT	7783
NETHERLANDS ANTILLES	6578
NEW CALEDONIA	7867
NIUE	7885
NORFOLK ISLAND	7870
NORTHERN MARIANA ISLANDS	7780
PITCAIRN	8078
TOKELAU	8475
TURKS AND CAICOS ISLANDS	8467
WALLIS AND FUTUNA ISLANDS	8770

## Setting up the parental level

You can change the level of parental lock (audio-visual restriction).

This function allows cutting scenes that are unfavorable for children or replacing them automatically with other scenes prepared in advance. For example, by replacing scenes of radical violence or portrayals of sex with safe scenes, you can make a trouble-free story as if it were so from the beginning.

\* The factory default setting is level "8".

- Following the steps 1 to 3 in "Selecting the monitor menu", select "PARENTAL" from "PREFERENCES", and press the "▶" button to go to the option list.

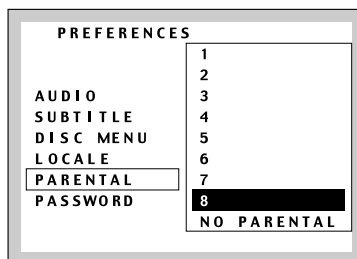

- Press the "▲" or "▼" button to select a parental level. You can select from 1 to 8 or NO PARENTAL.
- Press the [ENT] button to display the PASSWORD VERIFICATION screen.

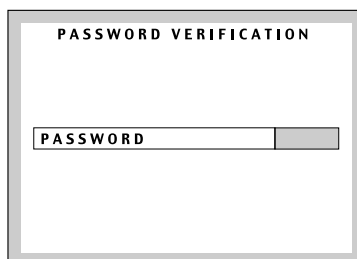

- Press the ten-key buttons to input a 4-digit password.

\* Factory default setting is "0000".

## Setting up the password for setting up of the parental level

- Following the steps 1 to 3 in “Selecting the monitor menu”, select “PASSWORD” from “PREFERENCES”, and press the “▶” button to go to the option list.

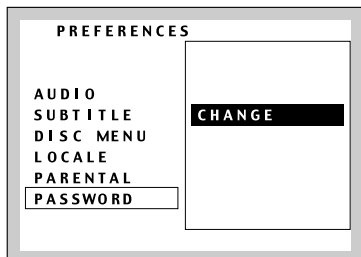

- Press the [ENT] button to display the PASSWORD CHANGE screen.

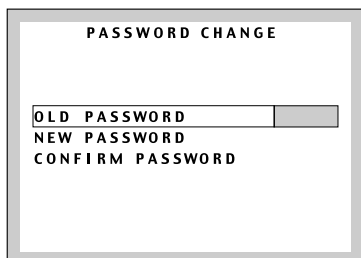

- Input an old password.
- Input a new password.
- Input a confirm password.

It is recommended that you take down a memo about the password and keep it safely to avoid forgetting it.

If you forget your password, you can set a new password by entering [4356] as the OLD PASSWORD.

### Note:

**When a disc with view limited is played**

- When a disc with view limited is played, the input screen requiring you to input the password may appear. When this happens, enter the correct password, otherwise play does not start.

## Turning on/off speakers

You can turn on/off or select the size of front speakers, a center speaker, surround speakers, and a subwoofer depending on your speaker system.

- Following the steps 1 to 3 in “Selecting the monitor menu”, select “SP-SEL” from “AUDIO SETUP”.

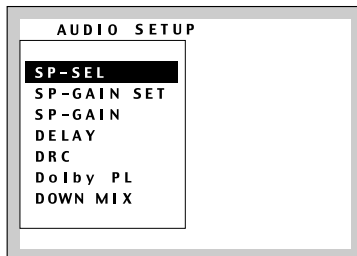

- Press the [ENT] button to display the SP-SEL screen.

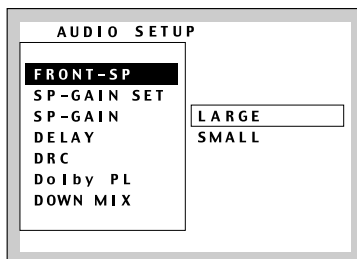

Each time you press the [ENT] button, the setting item changes as following order:

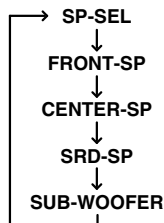

- Press the "▶" button to go to the option list and press "▲" or "▼" buttons to select the setting.  
You can select the settings as shown in the following table.

FRONT-SP (Front speaker)	LARGE *
	SMALL
CENTER-SP (Center speaker)	SMALL *
	OFF
SRD-SP (Surround speaker)	LARGE *
	SMALL
	OFF
SUB-WOOFER (Subwoofer)	ON *
	OFF

Asterisk (\*) indicates the factory default setting.

When you select "SMALL" for FRONT-SP, setting for other speakers is subject to following restriction.

- SRD-SP cannot be set to "LARGE".
- SUB-WOOFER cannot be set to "OFF".
- Only the following 4 patterns are available.

FRONT-SP	CENTER-SP	SRD-SP	SUB-WOOFER
SMALL	SMALL	SMALL	ON
SMALL	SMALL	OFF	ON
SMALL	OFF	SMALL	ON
SMALL	OFF	OFF	ON

- Press the [ENT] button.
- Press the "◀" button to go back to the left pane.
- Repeat steps 2 to 4 to turn on/off each speaker.

## Setting the speaker gain

- If you select "OFF" for this function, you cannot adjust the speaker gain.
- This function appears only when there is no disc loaded or playback stops.
- The factory default setting is "OFF".

- Following the steps 1 to 3 in "Selecting the monitor menu", select "SP-GAIN SET" from "AUDIO SETUP", and press the "▶" button to go to the option list.

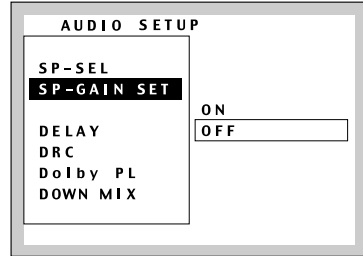

- Press "▲" or "▼" buttons to select "ON" or "OFF".
- Press the [ENT] button.

## Adjusting the speaker gain

- This function cannot be operated when the disc is loaded or when "SP-GAIN SET" is set to "OFF".
- You cannot adjust the speaker gain for speakers set to "OFF" in "SP-SEL".
- The factory default setting is "0 dB".

- Following the steps 1 to 3 in "Selecting the monitor menu", select "SP-GAIN" from "AUDIO SETUP".

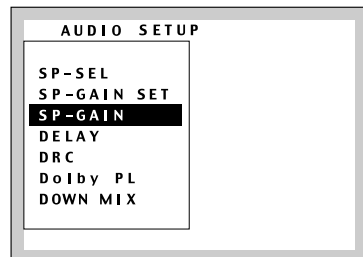

## Changing Initial Settings such as Menu Language, etc.

- Press the [ENT] button to display the SP-GAIN screen.

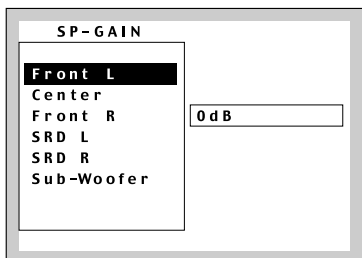

- Press “▲” or “▼” buttons to select the speaker.

Each time you press the buttons, you can switch among speakers.

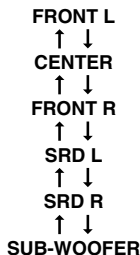

The test tone is output from the speaker you select.

- Press “▶” button to go to the right pane.
- Press “▲” or “▼” buttons to adjust the speaker gain. The gain level ranges from “-6dB” to “+6dB”.
- Press the “◀” button to go back to the left pane.
- Repeat steps 3 to 5 to adjust the each speaker gain.

### Note:

- The test tone will not be output when DVD or CD is being played with mute ON.

In that case, press the [MUTE] button on the remote control unit to cancel the mute, or adjust the volume.

## Adjusting the speaker delay time

The time necessary for sound to travel from speakers to a listener differs depending on the speaker location or the car size. By adjusting the delay time of each speaker, you can hear the sound from the front speakers and the other speakers simultaneously.

- This function cannot be operated when CENTER-SP and SRD-SP are set to “OFF” in “SP-SEL”.
- The factory default setting is “0 ms”.

- Following the steps 1 to 3 in “Selecting the monitor menu”, select “DELAY” from “AUDIO SETUP”.

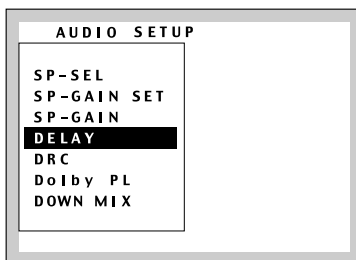

- Press the [ENT] button to display the DELAY screen.

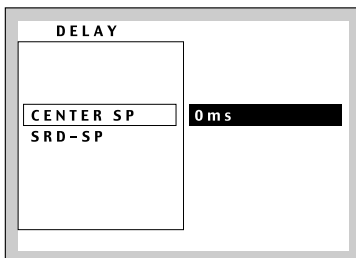

- Press “▲” or “▼” buttons to select the item.

Each time you press the buttons, you can switch between center and surround speakers.

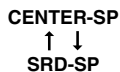

- Press “▶” button to go to the right pane.
- Press “▲” or “▼” buttons to adjust the delay time. The delay time ranges from “0 ms” to “5 ms” when you select “CENTER-SP” (1ms step), or “0ms” to “15ms” when you select “SRD-SP” (3ms step).

6. Press the [ENT] button.

### Adjusting the dynamic range

This function allows you to adjust the dynamic range, the ratio of the loudest sounds to the quietest sounds.

\* The factory default setting is "MAX".

1. Following the steps 1 to 3 in "Selecting the monitor menu", select "DRC" from "AUDIO SETUP".

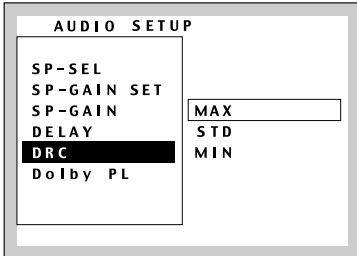

2. Press "▶" button to go to the right pane.
3. Press "▲" or "▼" buttons to select the setting. You can select the dynamic range from "MIN", "STD", or "MAX".
4. Press the [ENT] button.

### Setting the Dolby Pro Logic Decode processing

You can set whether or not 2-channel source is processed using Dolby Pro Logic Decode.

\* The factory default setting is "ON".

1. Following the steps 1 to 3 in "Selecting the monitor menu", select "Dolby PL" from "AUDIO SETUP".

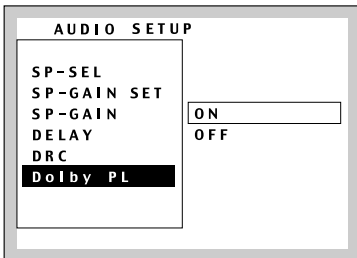

2. Press "▶" button to go to the right pane.
3. Press "▲" or "▼" buttons to select "ON" or "OFF".
4. Press the [ENT] button.

### Setting the down mix

\* This function can be operated only when the speakers other than FRONT-SP are set to "OFF" in "SP-SEL".

This function allows you to select the method of down-mixing when the channel format and the output channel configuration are not in agreement.

\* The factory default setting is "Lo/Ro".

1. Following the steps 1 to 3 in "Selecting the monitor menu", select "DOWN MIX" from "AUDIO SETUP".

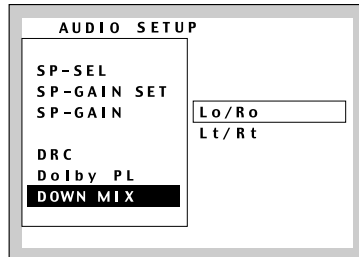

2. Press "▶" button to go to the right pane.
3. Press "▲" or "▼" buttons to select "Lo/Ro" or "Lt/Rt".  
 "Lo/Ro": Down-mixing the discrete 5-channel master etc. to 2-channel stereo track  
 "Lt/Rt": Writing down matrix-encoded sounds to 2-channel stereo track
4. Press the [ENT] button.

## Common Operations

### Display Adjust Mode

#### Setting the clock

1. Press and hold the [DISP] button for 1 second or longer to switch to the display adjust mode.
2. Press the [◀|▶] button to select "CLOCK E".
3. Press the [▶|▶] button.
4. Press the [◀|▶] button to select the hour or the minute.
5. Turn the [ROTARY] knob to set the correct time.  
\* The clock is displayed in 12-hour format.
6. Press the [▶|▶] button to store the time into memory.
7. Press the [DISP] button to return to the previous mode.

#### Note:

- You cannot set the clock when it is displayed with only the ignition on. If you drain or remove the car's battery or take out this unit, the clock is reset. While setting the clock, if another button or operation is selected, the clock set mode is canceled.

#### Turning the screen saver function on or off

This unit features various screen saver patterns that are exhibited across the display. If the screen savers are not desired, they can be turned off.

If the button operation is performed with the screen saver function on, the operation display corresponding to the button operation is shown for about 30 seconds and the display returns to the screen saver display.

\* The factory default setting is "ON".

1. Press and hold the [DISP] button for 1 second or longer to switch to the display adjust mode.
2. Press the [◀|▶] button to select "SCREEN SVR".
3. Turn the [ROTARY] knob to select the setting. Each time you turn the [ROTARY] knob, the setting changes in the following order:  
**OFF → ON → MESSAGE**
4. Press the [DISP] button to return to the previous mode.

### Entering MESSAGE INFORMATION

When "MESSAGE" is selected for the screen saver setting, you can change the contents of the message.

\* Up to 30 characters can be entered.

\* The factory default setting is "Welcome to Clarion".

1. Press and hold the [DISP] button for 1 second or longer to switch to the display adjust mode.
2. Press the [◀|▶] button to select "MSG INPUT E".
3. Press the [▶|▶] button.
4. Press the [◀|▶] button to move the cursor.
5. Press the [BND] button to select a character. Each time you press the [BND] button, the character changes in the following orders:  
**Capital letters → Small letters → Numbers and Symbols → Umlaut → Capital letters...**
6. Turn the [ROTARY] knob to select the desired character.
7. Repeat steps 4 to 6 to enter up to 30 characters for message.
8. Press and hold the [▶|▶] button for 2 seconds or longer to store the message in memory and return to the display adjust mode.

\* Press and hold the [BND] button for 1 second or longer to delete the message. Then press and hold the [▶|▶] button for 2 seconds or longer to return the message to the default setting.

9. Press the [DISP] button to return to the previous mode.

#### Setting the method for title scroll

Set how to scroll in CD-TEXT, MP3/WMA TITLE.

\* The factory default setting is "ON".

1. Press and hold the [DISP] button for 1 second or longer to switch to the display adjust mode.
2. Press the [◀|▶] button to select "AUTO SCROL".
3. Turn the [ROTARY] knob to select "ON" or "OFF".
  - **ON:**  
Scrolls automatically.
  - **OFF:**  
Scrolls just 1 time when the title was changed or you press and hold the [TITLE] button for 1 second or longer.
4. Press the [DISP] button to return to the previous mode.



## Dimmer control

You can set the dimmer control.

\* The factory default setting is “ON”.

1. Press and hold the [DISP] button for 1 second or longer to switch to the display adjust mode.
2. Press the [◀]/[▶] button to select “DIMMER”.
3. Turn the [ROTARY] knob to select “ON” or “OFF”.
4. Press the [DISP] button to return to the previous mode.

## Adjusting the display contrast

You can adjust the display contrast to match the angle of installation of the unit.

\* The factory default setting is “5”. (Adjustment level: 1 to 16)

1. Press and hold the [DISP] button for 1 second or longer to switch to the display adjust mode.
2. Press the [◀]/[▶] button to select “CONTRAST”.
3. Turn the [ROTARY] knob to adjust the contrast.
4. Press the [DISP] button to return to the previous mode.

## Adjust Mode

### Setting the low pass filter

\* This function can only be adjusted when the subwoofer output is set to “ON” and the speaker system is set to “5.1ch”. For details on how to set the subwoofer, refer to the subsection “Turning on/off speakers” in the section “Changing Initial Settings such as Menu Language, etc.”.

\* This function cannot be adjusted when as follows: “Pro Logic” is set to “ON”, the speaker system is set to “5.1ch”, DVD/DTS-CD is being played.

\* The factory default setting is “THROUGH”. If the speaker system is set to “5.1ch”, the factory default setting is “50Hz”.

1. Press the [ADJ] button to switch to the adjust mode.
2. Press the [◀]/[▶] button to select “SUB-W LPF”.
3. Turn the [ROTARY] knob to select the setting. Each time you turn the [ROTARY] knob, the setting changes in the following order:  
**THROUGH → 50Hz → 80Hz → 120Hz**
4. Press the [ADJ] button to return to the previous mode.

## Setting the amplifier bypass circuit

\* The factory default setting is “OFF”.

1. Press the [ADJ] button to switch to the adjust mode.
2. Press the [◀]/[▶] button to select “AMP CANCEL”.
3. Turn the [ROTARY] knob to select “ON” or “OFF”.
  - ON:  
Uses with connected AMP.
  - OFF:  
Uses with inside AMP.
4. Press the [ADJ] button to return to the previous mode.

## Adjusting the auxiliary input sensitivity

Adjust the auxiliary sensitivity when the audio from an external device is difficult to hear even after adjusting the volume.

\* The factory default setting is “MID”.

1. Press the [ADJ] button to switch to the adjust mode.
2. Press the [◀]/[▶] button to select “AUX SENSE”.
3. Turn the [ROTARY] knob to select from “LOW”, “MID” or “HIGH”.
4. Press the [ADJ] button to return to the previous mode.

## Performing a system check

This function verifies the devices hooked up through CeNET.

1. Press the [ADJ] button to switch to the adjust mode.
2. Press the [◀]/[▶] button to select “SYSTEM CHK VXZ756

## Common Operations

### Other operations

#### Entering titles

Titles up to 10 characters long can be stored in memory and displayed for CD, CD changer and Radio/TV stations. The number of titles that can be entered for each mode are as follows.

Mode	Number of titles
CD mode	50 titles
TV mode	20 titles
Radio mode	30 titles

CD changer mode	Number of titles
DCZ625 connected	100 titles
CDC655Tz connected	100 titles

1. Press the **[SRC]** button to select the mode you want to enter a title (Radio, CD, CD changer or TV).
2. Play a track or tune in to a radio/TV station for which you want to enter the title.
3. Do one of the following:
  - **In the CD or CD changer mode**  
Press the **[TITLE]** button to select “**USER TITLE**”.
  - **In the radio or TV mode**  
Skip this step.
4. Press and hold the **[TITLE]** button for 1 second or longer to switch to the title input display.
5. Press the **[◀|▶]** button to move the cursor.
6. Press the **[BND]** button to select a character. Each time you press the **[BND]** button, the character changes in the following order:  
**Capital letters → Small letters → Numbers and Symbols → Umlaut → Capital letters...**
7. Turn the **[ROTARY]** knob to select the desired character.
8. Repeat steps 5 to 7 to enter up to 10 characters for the title.
9. Press and hold the **[▶|||]** button for 2 seconds or longer to store the title into memory and return to the previous mode.

#### Clearing titles

1. Play a track or tune in to a radio/TV station for which you want to delete the title.
2. Do one of the following:
  - **In the CD or CD changer mode**  
Press the **[TITLE]** button to select “**USER TITLE**”.
  - **In the radio or TV mode**  
Skip this step.
3. Press and hold the **[TITLE]** button for 1 second or longer to switch to the title input display.
4. Press and hold the **[BND]** button for 1 second or longer to delete the title.
5. Press and hold the **[▶|||]** button for 2 seconds or longer to store the setting and return to the previous mode.

#### Cellular telephone mute

This unit requires special wiring to mute the audio signal automatically when a cellular telephone rings in the car.

\* This function is not compatible with all cellular telephones. Contact your local authorized Clarion dealer for information on proper installation and compatibility.

#### AUX function

This system has an external input jack so you can listen to audio from an external device connected to this unit.

# 9. OPERATIONS OF ACCESSORIES

## CD Changer Operations

### CD changer functions

When an optional CD changer is connected through the CeNET cable, this unit controls all CD changer functions. This unit can control a total of 2 changers.

Press the [SRC] button and select the CD changer mode to start play. If 2 CD changers are connected, press the [SRC] button to select the CD changer for play.

- \* If “**NO MAG**” appears in the display, insert the magazine into the CD changer. “**DISC CHECK**” appears in the display while the player loads (checks) the magazine.
- \* If “**NO DISC**” appears in the display, eject the magazine and insert discs into each slot. Then, reinsert the magazine back into the CD changer.

#### Note:

- Some CDs recorded in CD-R/CD-RW mode may not be usable.

### ⚠ CAUTION

CD-ROM discs cannot be played from every CD changer, it's depended on the model.

### Pausing play

1. Press the [▶||] button to pause play. “**PAUSE**” appears in the display.
2. To resume play, press the [▶||] button again.

### Displaying CD titles

This unit can display title data for CD-text CDs and user titles input with this unit.

- **When connected to CDC655Tz or DCZ625**  
Each time you press the [TITLE] button, the title changes in the following order:

**User title (disc) → CD-text title (disc) → Artist name → CD-text title (track) → User title (disc)...**

#### Notes:

- If the CD playing is not a CD-text CD or no user title has been input, “**NO TITLE**” appears in the display.
- If a CD-text CD is not input its disc title or a track title, “**NO TITLE**” appears in the display.

### Procedure to scroll a title

Set “**AUTO SCROL**” to “**ON**” or “**OFF**”.

(The factory default setting is “**ON**”. Refer to the subsection “**Setting the method for title scroll**” in section “**Common Operations**”.)

#### ● When set to “ON”

The title is automatically kept scrolling.

#### ● When set to “OFF”

To scroll just 1 time when the title was changed or you press and hold the [TITLE] button for 1 second or longer.

### Selecting a CD

Press the [UP] or [DN] button to select the desired disc.

- \* If a CD is not loaded in a slot of magazine, pressing the [UP] or [DN] button can not work.
- \* Pressing the [BND] button also advances to next disc.

### Selecting a track

#### ● Track-up

1. Press the [▶▶] button to move ahead to the beginning of the next track.
2. Each time you press the [▶▶] button, the track advances ahead to the beginning of the next track.

#### ● Track-down

1. Press the [◀◀] button to move back to the beginning of the current track.
2. Press the [◀◀] button twice to move to the beginning of the previous track.

### Fast-forward/fast-rewind

#### ● Fast-forward

Press and hold the [▶▶] button for 1 second or longer.

#### ● Fast-rewind

Press and hold the [◀◀] button for 1 second or longer.

### ***Scan play***

Scan play locates and plays the first 10 seconds of each track on a disc automatically. This function continues on the disc until it is cancelled.

\* The scan play is useful when you want to select a desired track.

1. Press the [**SCN**] button.
2. To cancel the scan play, press the [**SCN**] button again.

### ***Disc scan play***

Disc scan play locates and plays the first 10 seconds of the first track on each disc in the currently selected CD changer. This function continues automatically until it is cancelled.

\* Disc scan play is useful when you want to select a desired CD.

1. Press and hold the [**SCN**] button for 1 second or longer.
2. To cancel disc scan play, press the [**SCN**] button again.

### ***Repeat play***

Repeat play continuously plays the current track. This function continues automatically until it is cancelled.

1. Press the [**RPT**] button.
2. To cancel repeat play, press the [**RPT**] button again.

### ***Disc repeat play***

After all the tracks on the current disc have been played, disc repeat play automatically replays the current disc over from the first track. This function continues automatically until it is cancelled.

1. Press and hold the [**RPT**] button for 1 second or longer.
2. To cancel disc repeat play, press the [**RPT**] button again.

### ***Random play***

Random play selects and plays individual tracks on the disc in no particular order. This function continues automatically until it is cancelled.

1. Press the [**RDM**] button.
2. To cancel random play, press the [**RDM**] button again.

### ***Disc random play***

The disc random play selects and plays individual tracks or discs automatically in no particular order. This function continues automatically until it is cancelled.

1. Press and hold the [**RDM**] button for 1 second or longer.
2. To cancel disc random play, press the [**RDM**] button again.

# TV Operations

## TV tuner functions

When an optional TV tuner is connected through the CeNET cable, this unit controls all TV tuner functions. To watch TV it requires a TV tuner and a monitor.

### Watching a TV

1. Press the [SRC] button and select the TV mode.
2. Press the [BND] button to select the desired TV band (TV1 or TV2). Each time the button is pressed, the input selection toggles between TV1 and TV2.
3. Press the [◀|▶] button to tune in the desired TV station.

### Watching a video

The TV tuner features a VTR input for an external A/V source, such as a game station.

1. Press and hold the [ADJ] button for 1 second or longer to select VTR.
2. To return to the TV broadcast, press and hold the [ADJ] button for 1 second or longer.

### TV tuning

There are 3 types of TV tuning modes available, seek, manual and preset tuning.

#### Seek tuning

1. Press the [BND] button and select the desired TV band (TV1 or TV2).
  - \* If "MANU" is lit in the display, press and hold the [BND] button for 1 second or longer. "MANU" in the display goes off and seek tuning is now available.
2. Press the [◀|▶] button to automatically seek a station. Press the [▶] button to automatically tune up the frequency band to the next available TV station; press the [◀] button to automatically tune down.

#### Manual tuning

There are 2 ways available: Quick tuning and step tuning.

When you are in the step tuning mode, the frequency changes one step at a time. In the quick tuning mode, you can quickly tune the desired frequency.

1. Press the [BND] button and select the desired band (TV1 or TV2).

\* If "MANU" is not lit in the display, press and hold the [BND] button for 1 second or longer. "MANU" lights in the display and manual tuning is now available.

2. Tune into a station.

#### ● Quick tuning:

Press and hold the [◀|▶] button for 1 second or longer to tune in a station.

#### ● Step tuning:

Press the [◀|▶] button to manually tune in a station.

### Recalling a preset station

A total of 12 TV stations can be stored (6-TV1 and 6-TV2). This allows you to select your favorite TV stations and store them in memory.

1. Press the [BND] button and select the desired TV band (TV1 or TV2).
2. To recall a stored TV station, press the desired [DIRECT] button to select that station.
  - \* Press and hold one of the [DIRECT] buttons for 2 seconds or longer to store the current station into preset memory.

### Manual memory

1. Select the desired station with seek tuning, manual tuning or preset tuning.
2. Press and hold one of [DIRECT] buttons for 2 seconds or longer to store the current station into preset memory.

### Auto store

Auto store selects 6 TV stations automatically and stores each one into preset memory.

If the 6 stations with good reception are not available, stations previously stored in memory remain. Only stations with strong reception are stored into memory.

1. Press the [BND] button and select the desired TV band (TV1 or TV2).
2. Press and hold the [PS/AS] button for 2 seconds or longer. The stations with good reception are stored automatically to the preset channels.

## TV Operations

### Preset scan

Preset scan allows the user to view each preset position before it automatically advances to the next preset. This function is useful for searching for a desired TV station in memory.

1. Press the **[PS/AS]** button.
2. When the desired station is found, press the **[PS/AS]** button again to remain tuned to that station.

#### Note:

- Do not press and hold the **[PS/AS]** button for 2 seconds or longer. Doing so will trigger the auto store function and start storing stations into memory.

### Setting up the TV type

Set the TV type to NTSC, PAL, MULTI.

1. Press the **[ADJ]** button to switch to the adjust mode.
2. Press the **[◀]/[▶]** button to select **"TV TYPE"**.
3. Turn the **[ROTARY]** knob to select the setting.

Each time you turn the **[ROTARY]** knob, the setting changes in the following order.

**MULTI → NTSC → PAL**

4. Press the **[ADJ]** button to return to the previous mode.

### Setting the TV area

When you select the TV area (TV reception area), the TV tuner area setting changes.

1. Press the **[ADJ]** button to switch to the adjust mode.
2. Press the **[◀]/[▶]** button to select **"TV AREA [E]"**.
3. Press the **[▶||]** button.
4. Turn the **[ROTARY]** knob to select the reception area.
5. Press the **[▶||]** button.
6. Press the **[ADJ]** button to return to the previous mode.

The above operations are required when a TV tuner other than TTX7501z is connected.

### Setting the TV diver

You can change the reception setting for the TV antenna connected to the TV tuner.

\* The factory default setting is **"ON"**.

1. Press the **[ADJ]** button to switch to the adjust mode.
2. Press the **[◀]/[▶]** button to select **"TV DIVER"**.
3. Turn the **[ROTARY]** knob to select **"ON"** or **"OFF"**.

#### ● ON:

Sets the diver setting to ON.

#### ● OFF:

Sets the diver setting to OFF.

4. Press the **[ADJ]** button to return to the previous mode.

# 10. IN CASE OF DIFFICULTY

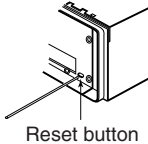
	Problem	Cause	Measure
General	Power does not turn on. (No sound is produced.)	Fuse is blown.	Replace with a fuse of the same amperage. If the fuse blows again, consult Clarion dealer.
		Incorrect wiring.	Consult Clarion dealer.
	No audio when operating the unit with amplifiers.	Amplifier turn-on lead is shorted to ground or excessive current is required.	Turn the unit off and check each wire for a possible short. If the amplifier turn-on lead shorts out, cover it with insulation such as tape.
	Nothing happens when buttons are pressed.	The microprocessor has malfunctioned due to noise, etc.	Turn off the power, then press the <b>[RELEASE]</b> button and remove the DCP. Press the reset button for about 2 seconds with a thin rod. 
	Display is not accurate.	DCP or source unit connectors are dirty.	Wipe the dirt off with a soft cloth moistened with cleaning alcohol.
	No audio.	The speaker protection circuit is operating.	1. Check the speaker connection. 2. Turn down sound volume. Function can also be restored by turning the power off and on again. 3. If the sound is muted again, consult Clarion dealer.
DVD (CD/MP3/WMA)	No audio.	MP3/WMA files are absent on the disc.	Write MP3/WMA files onto the disc properly.
		Files are not recognized as an MP3/WMA file.	Use MP3/WMA files encoded properly.
		File system is not correct.	Use ISO9660 level 1, 2 or JOLIET or Romeo file system.
	Sound skips or is noisy.	Disc is dirty.	Clean the disc with a soft cloth.
		Disc is heavily scratched or warped.	Replace with a disc with no scratches.
	Sound is cut or skipped. Noise is generated or noise is mixed with sound.	MP3/WMA files are not encoded properly.	Use MP3/WMA files encoded properly.
	Poor sound quality in extremely cold weather or extreme humidity.	Water droplets may form on the internal lens when the car is parked in a humid place.	Let dry for about 1 hour with the power on.
	Wrong filename	File system is not correct.	Use ISO9660 level 1, 2 or JOLIET or Romeo file system.
Play list play is not performed.	File name or extension is not correct.	Use ASCII characters for MP3/WMA file name. Use <b>“.M3U”</b> for the file extension of a play list.	

# 11. ERROR DISPLAYS

If an error occurs, one of the following displays is displayed.  
Take the measures described below to eliminate the problem.

	Error Display	Cause	Measure
DVD (CD/MP3/WMA)	<b>ERROR 2</b>	A DISC is caught inside the DVD deck and is not ejected.	This is a failure of DVD deck's mechanism and consult Clarion dealer.
	<b>ERROR 3</b>	A DISC cannot be played due to scratches, etc.	Replace with a non-scratched disc.
	<b>ERROR 6</b>	A DISC is loaded upside-down inside the DVD deck and cannot play.	Eject the disc then reload it properly.
	<b>ERROR P</b>	Parental level error	Set the correct Parental level.
	<b>ERROR R</b>	Region code error	Eject the disc and replace correct region code disc.
CD changer	<b>ERROR 2</b>	A DISC inside the CD changer is not loaded properly.	This is a failure of CD changer's mechanism and consult Clarion dealer.
	<b>ERROR 3</b>	A DISC inside the CD changer cannot be played due to scratches, etc.	Replace with a non-scratched disc.
	<b>ERROR 6</b>	A DISC inside the CD changer cannot be played because it is loaded upside-down.	Eject the disc then reload it properly.

If an error display other than the ones described above appears, press the reset button. If the problem persists, turn off the power and consult Clarion dealer.



# 12. SPECIFICATIONS

## **FM Tuner**

Frequency Range:  
87.0 MHz to 108.0 MHz

Usable Sensitivity:  
9 dBf

50dB Quieting Sensitivity:  
15 dBf

Alternate Channel Selectivity:  
70 dB

Stereo Separation (1 kHz):  
35 dB

Frequency Response ( $\pm 3$  dB):  
30 Hz to 15 kHz

## **AM Tuner**

Frequency Range:  
531 kHz to 1629 kHz

Usable Sensitivity:  
25  $\mu$ V

## **DVD Player section**

System:  
Digital Versatile Disc System with CDDA capable

Usable Discs:  
DVD Video Disc, Video CD, Compact disc

Frequency Response:  
20 Hz to 22 kHz ( $\pm 1$  dB)

Signal to Noise Ratio:  
100 dB

Distortion:  
0.02%

Channel Separation:  
80 dB

Analog audio output:  
2.0 Vrms

## **Audio**

Maximum Power Output:  
208 W (52 W  $\times$  4 ch)

Continuous Average Power Output:  
17 W  $\times$  4, into 4  $\Omega$ , 20 Hz to 20 kHz, 1%THD

Bass Control Action (60 Hz/100 Hz/200 Hz):  
+16 dB, -12dB

Treble Control Action (10 kHz/15 kHz):  
 $\pm 12$  dB

Line Output Level (CD 1 kHz):  
2.0 V

## **General**

Power Supply Voltage:  
14.4 V DC (10.8 to 15.6 V allowable), negative ground

Current Consumption:  
Less than 15 A, 3A

Speaker Impedance:  
4  $\Omega$  (4  $\Omega$  to 8  $\Omega$  allowable)

Weight / Source unit:  
4 lb. (1.6 kg)

Weight / Remote control unit:  
3.5 oz. (100 g) (including battery)

Dimensions / Source unit:  
7" (Width)  $\times$  2" (Height)  $\times$  6-5/16" (Depth)  
[178 (W)  $\times$  50 (H)  $\times$  156.5 (D) mm]

Dimensions / Remote control unit:  
2-1/8" (Width)  $\times$  6-1/8" (Height)  $\times$  1-1/16" (Depth)  
[54 (W)  $\times$  155 (H)  $\times$  27 (D) mm]

### **Note:**

- Specifications and design are subject to change without notice for further improvement.



